



RADIO'S LIVEST MAGAZINE

Special
Television
Number

Radio-Craft

August
25 Cents

Canada 30c

HUGO GERNSBACK Editor

MULTIPLE-IMAGE TELEVISION RECEIVER

See Page 74



Television in the U. S., Canada, Europe and Japan—Cathode-Ray Tubes
Making a Facsimile Apparatus—"Frequency" vs. "Amplitude" Modulation

NOW READY!

The 1935 Official AUTO-RADIO SERVICE MANUAL



HERE NOW—is the second volume of the OFFICIAL AUTO-RADIO SERVICE MANUAL—the 1935 Edition.

With so large a number of new auto-radio sets placed on the market by different manufacturers, the 1935 OFFICIAL AUTO-RADIO SERVICE MANUAL becomes an essential part of Service Men's equipment. Remember, there are nearly 1,800,000 auto-radio sets in use today.

The 1935 OFFICIAL AUTO-RADIO SERVICE MANUAL (Volume II), contains 100% new material. It gives schematic diagrams, chassis layouts, mounting instructions, and trouble-shooting hints on all modern auto-radio receivers, and older models as well.

THERE IS ABSOLUTELY NO DUPLICATION OF MATERIAL BETWEEN THE 1933 EDITION (VOLUME I) AND THE NEW 1935 EDITION (VOLUME II). THE MATERIAL IS 100% NEW.

Every radio man connected in any way with the booming auto-radio business needs a copy of the new OFFICIAL AUTO-RADIO SERVICE MANUAL. It contains only auto-radio service "dope."

HERE ARE ADDITIONAL HIGHLIGHTS OF THE NEW, 1935 EDITION OF THE OFFICIAL AUTO-RADIO SERVICE MANUAL

- 240 big pages crowded with diagrams, service material and other essential data required for proper servicing of new auto-radio receivers. Included are diagrams of sets which appeared during 1934, and which were not included in the supplement to the first edition.
- Complete schematic diagrams, chassis layouts, voltage tabulations and servicing instructions are included for practically all sets. "Under-side" tube symbols are also included to facilitate the job of servicing the sets.
- Instructions are included with many sets telling how to suppress stubborn cases of ignition interference. This includes the newest "suppressorless" sets—and what to do when interference is encountered with this type of set.
- Details on how to make installation in "turret-top" cars are included. The different methods used by car makers and set manufacturers are listed with the individual circuits and service information.
- The index contains the listing of sets which were published in the first edition, as well as the sets which appear in the new volume. This information helps the Service Man to locate the circuit and details for any receiver that has been made.
- The book is bound in a handy, flexible leatherette cover. To be sure the pages are sturdy, to withstand constant use, the book will be printed on a special "bible" stock. This is a very durable, but thin paper. The book printed on this paper can be easily rolled to fit into your pocket or slipped in the service kit.

\$2.50
PER COPY

Volume II

Over 240 Pages Printed on Special
Thin "Bible Paper"

Over 500 Illustrations

Flexible, Looseleaf Leatherette Cover

MAIL COUPON TODAY!

GERNSBACK PUBLICATIONS, Inc. Dept. RC-835
99 Hudson Street, New York, N.Y.

Enclosed you will find my remittance of \$2.50 for which send me One Copy of the 1935 OFFICIAL AUTO-RADIO SERVICE MANUAL (Volume II). (Send remittance in check or money-order; register letter if it contains cash or currency).

Name.....

Address.....

City..... State.....

(The 1935 OFFICIAL AUTO-RADIO SERVICE MANUAL is shipped postage prepaid.)

Here Is a Complete List of Sets Covered

Acme Radio Mfg. Co.	Freed Television & Radio Corp.	Premier Electric Co.
Allied Radio Corp.	Galvin Mfg. Corp.	Radio Chassis, Inc.
Atwater Kent Mfg. Co.	General Electric Co.	Radolek Company
Audiola Radio Co.	General Motors Corp.	RCA Manufacturing Co., Inc.
Autocrat Radio Co.	A. H. Grebe & Co.	Remler Co., Ltd.
Automatic Radio Mfg. Co.	Graham-Paige Motors Corp.	R. K. Radio Lab.
Belmont Radio Corp.	Grigsby-Grunow Co.	Sears Roebuck & Co.
Carter Motor Corp.	Gulbransen Co.	Sentinel Radio Corp.
Century Radio Products Co.	Halsorn Radio Mfg. Co.	Simplex Radio Co.
Chevrolet Motor Corp.	Hi-Lo Radio Co.	Sparks-Withington Co.
Chrysler Motor Corp.	Chas. Hoodwin Co.	Stewart Radio Corp.
Colonial Radio Corp.	Howard Radio Co.	Stewart-Warner Corp.
Consolidated Industries Ltd.	Hudson Motor Car Corp.	Stromberg-Carlson Tel. Mfg. Co.
Crosley Radio Corp.	International Radio Corp.	L. Tatro Products Corp.
Delco Appliance Corp.	Karadio Corp.	Transformer Corp. of America
Detrola Radio Corp.	P. R. Mallory & Co.	United American Bosch Corp.
Emerson Electric Mfg. Co.	Melburn Radio Mfg. Co.	United Motors Service Inc.
Emerson Radio & Phonograph Co.	Mission Bell Radio Co.	U. S. Radio & Television Corp.
Fada Radio & Electric Corp.	Montgomery Ward & Co.	Utah Radio Products Co.
Federated Purchaser, Inc.	National Company, Inc.	Wells Gardner & Co.
Ford Motor Corp.	Noblitt-Sparks Industries, Inc.	Wholesale Radio Service Co.
Ford-Majestic	Philco Radio & Television Corp.	Wilcox-Gay Corp.
Franklin Radio Corp.	Pierce Airo, Inc.	Rudolph Wurlitzer Mfg. Co.
		Zenith Radio Corp.

GERNSBACK PUBLICATIONS, Inc.
99 HUDSON STREET NEW YORK, N. Y.



STUDENTS BUSY AT WORK IN GREAT COYNE SHOPS

Learn RADIO

Send Today for Details of My "Pay-Tuition-After-Graduation" Plan!

Train for Radio in 12 weeks, right here in the great Coyne Shops — not by correspondence — but on real Radio, Sound and Television equipment. Mail the coupon below. If you are short of money I'll send you all details of my finance plan and consider your application. If accepted, you won't have to start paying tuition back until five months from the date you start school, and then you'll have over a year to complete your payments.

Tremendous Developments Ahead in Radio and Television!

HERE is YOUR opportunity to cash in. Every day brings news of new developments in every branch of Radio and Television, with more opportunities, more jobs, and a greater future for the trained man than ever before. I consider the fellow who is ambitious enough to want to get ahead by taking my Training, worthy of my help. MAIL THE COUPON BELOW and you can prove to me that you are willing to spend just 12 weeks in the Coyne Training Shops learning Radio. Then, I'll tell you about my finance plan which has enabled many to get complete Training and pay tuition back later.

Learn By Doing In 12 Weeks

I don't care whether you are 16 or 45. It makes no difference to me if you don't know an oscillator from a spark coil. You don't need any previous experience or advanced education to master my Shop Training. Don't let lack of money hold you back from getting all details of my amazing plan.

MANY EARN While LEARNING

If you need part-time work to help pay your living expenses and will tell us your problems we may be able to help you as we have thousands of others. Then, in 12 brief weeks, in the great Training shops of Coyne, you will learn on a wide variety of modern, up-to-date A. C. Super-heterodyne sets, oscillators, analyzers and test instruments. Prepare for Amateur Broadcast, or Telegraph Radio Operator's License and to know all code and Dept. of Commerce rules for a government License Examination.

TRAINING

By Actual Work

No dull books . . . you get individual training . . . real actual work with only the theory you will need. Building real radio sets,

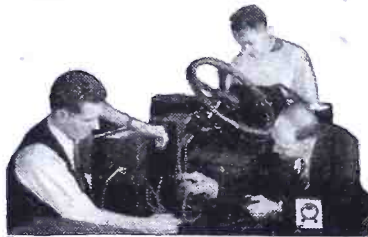

Auto Radio Instruction Prepare For Jobs Like These

Here are a few of hundreds of positions in the Radio field. My free employment bureau gives you life-time employment service.

- AIRCRAFT RADIO OPERATOR
- SHIP RADIO OPERATOR
- RADIO SERVICING
- PUBLIC ADDRESS SYSTEMS
- BROADCAST STATION OPERATOR
- TALKING PICTURE STUDIOS
- TELEVISION LABORATORY MAN

doing radio wiring and testing, trouble-shooting, repairing and servicing. That's a glimpse of how we help to make you a Radio expert, and fit you to qualify for jobs leading to the biggest pay.

Jobs - Pay - Future

"I got my present job two days after graduation, at shorter hours, and wages increased 60% over my old job," reports Arne Wiklem of Minnesota. "I have my own shop, own a real car and make fine money in the radio business," writes E. Allen of Montana, "All this is possible because I came to Coyne." And I could go on quoting from hundreds of letters of successful Coyne Trained men. What they have done, you should be able to do.

Electric Refrigeration Air Conditioning

Right now I'm including my big new Electric Refrigeration and Air Conditioning course at no extra cost.

GET THE FACTS

Coyne is your one great chance to get into Radio. This school is 36 years old—Coyne training is tested—proven beyond all doubt—endorsed by many large concerns. You can find out everything absolutely free. Simply mail the coupon and let me send you the big, free Coyne Book with photographs . . . facts . . . jobs . . . salaries . . . opportunities. Tells you how many earn expenses while training and how we assist our graduates in the field. This does not obligate you. So act at once. Just mail coupon.

Get this Free Book



Home of Coyne Shops

This is our fireproof modern Building wherein is installed thousands of dollars' worth of Radio equipment of all kinds. Every comfort and convenience has been arranged to make you happy and contented during your Training.

COYNE H. C. LEWIS, President **Founded 1899**
RADIO & ELECTRICAL SCHOOL
 500 South Paulina Street Dept. C5-8H, Chicago, Ill.

H. C. LEWIS, President
 Coyne Radio & Electrical School
 500 S. Paulina St. Dept. C5-8H, Chicago

Dear Mr. Lewis: Without obligation send me your big free catalog and all details; also tell me all about your "Pay-Tuition-After-Graduation" Plan.

Name.....
 Address.....
 City..... State.....

Please Say That You Saw It in RADIO-CRAFT



CONTENTS—AUG., 1935, ISSUE

Volume VII

Number 2

Editorial: Is Television Here?.....	Hugo Gernsback	69
The Radio Month in Review.....		70
Radio Pictorial.....		72
Presenting—The Multiple-Image Television Receiver.....	Hugo Gernsback	74
Television—Present and Future.....		
.....Dr. Lee DeForest and Dr. Alfred N. Goldsmith		75
Frequency vs. Amplitude Modulation.....	Major Edwin H. Armstrong	75
World-Wide Television.....		
.....R. D. Washburne and Wilhelm E. Schrage		76
Cathode-Ray Applications.....	Allen B. DuMont	81
Some Facts about the Farnsworth System.....		
.....A. H. Brolly and R. C. Hergenrother		82
RADIO-CRAFT'S "Ideal Radio Service Shop" Contest		83
A Beginner's "2-in-1" A.F. Amplifier.....	J. S. Caulfield	83
Readers' Department.....		84
How to Make a Facsimile Sender and Recorder.....		
.....John L. Rennick		85
The Latest Radio Equipment.....		86
Short-Cuts in Radio.....		88
International Radio Review.....		89
Television in the School.....	J. A. Robinson	90
An 8-Tube Short-Wave Kit-Set.....	S. O. Lawrence	90
A Convertible Auto-Type P.A. System.....	Hubert L. Shortt	91
The High-Gain Antenna-Stage.....		
.....Russell M. Blair and Jean Brand		91
The Design of Television Transformers.....	Leon J. Littmann	92
A Non-Motor Boating High-Gain Amplifier.....		
.....H. F. Shepard, Jr.		92
A Bi-Dimension P.A. and Television Amplifier.....		
.....Charles R. Shaw		93
A Test Unit for Sound Systems, Part II.....		
.....Harold H. Shotwell		93
A Versatile Wide-Range Condenser Tester.....		
.....J. R. Williams		94
Uses of the Cathode-Ray Oscilloscope, Part I.....		
.....F. M. Paret		94
A Simplified "Treasure" Locator.....	Harry L. Berry	95
The Fluorescent Screen in Cathode-Ray Tubes.....		
.....Alfred A. Ghirardi		95
Operating Notes.....		96
The Listening Post for All-Wave DX-ers.....	C. A. Morrison	97
Practical Methods of Servicing "Noise," Part II.....		
.....Pietro Muscari		97
RADIO-CRAFT'S Information Bureau.....		98
ORSMA Members' Forum.....		99
RADIO SERVICE DATA SHEETS:		
No. 143—Kadette Model 90 Duplex, Car-Home-Farm Super.; RCA-Victor "Magic Brain" Model 281.....		100
No. 144—Grunow 11A Chassis 11-Tube Superhet.....		101
Technicians' Data Service.....		104
Broadcasting 25 Years Ago.....	Leon J. Adelman	121
Book Reviews.....		127

HUGO GERNSBACK, Editor-in-Chief

C. W. PALMER
Associate Editor

J. S. CAULFIELD
Associate Editor

R. D. WASHBURNE, Technical Editor

TO RADIO SET BUILDERS—

At one time or another probably every person interested in radio has built some sort of a radio receiver. It will be interesting to draw comparisons and contrasts between these receivers and the new and interesting models that will be described in the forthcoming special Radio Set Builders' Number.

The radio sets described in this interesting forthcoming September issue include the use of "metal" tubes, crystal headphones operating on the piezoelectric principle, new "glass-metal" tubes, a 45-volt "B" battery only 1 1/4 inches thick, the new "pinkie"-size 1/16-ampere dry-cell tube, a variable-selectivity I.F. transformer, and other new and interesting devices.

The set designs include various types of portable sets. The smallest slips into a vest pocket, with room to spare. Other and sundry types of radio sets are described.

Every person interested in radio reception will find some construction design to interest him in the forthcoming Radio Set Construction Number. Ask your newsdealer today to reserve a copy for you.

RADIO-CRAFT is published monthly, on the first of the month preceding that of date; its subscription price is \$2.50 per year. (In Canada and foreign countries, \$3.00 a year to cover additional postage.) Entered at the post office at Mount Morris, Ill., as second-class matter under the act of March 3, 1879.

Text and illustrations of this magazine are copyright and must not be reproduced without permission of the copyright owners. We are also agents for WONDER STORIES and EVERYDAY SCIENCE AND MECHANICS. Subscription to these magazines may be taken in combination with RADIO-CRAFT at reduced Club rates. Write for information.

Copyright 1935. Continental Publications, Inc.

HUGO GERNSBACK, President I. S. MANHEIMER, Secretary

Published by Continental Publications, Inc. Publication office: 404 N. Wesley Ave., Mount Morris, Illinois. Editorial and Advertising Office: 99 Hudson Street, New York City. Chicago Advertising Office: L. F. McClure, 919 North Michigan Avenue, Chicago, Ill. Western Advertising Office: Loyd B. Chappell, 511 So. Alexandria St., Los Angeles, Calif.

European Agents:

London—Gorrings' American News Agency, 9A Green St., Leicester Square, London, W. C. 2.

Paris—Messageries Dawson, 4 Rue Faubourg, Poissonniere, Paris, France.

Australian Agent: McGil's Agency, 179 Elizabeth St., Melbourne.

How a "Tip" got Tom a Good Job

GEE, THERE'S DJ C IN BERLIN. THAT'S THE TENTH FOREIGN STATION TONIGHT. RADIO IS SURELY FUN.

HELLO, TOM, HOW'S EVERYTHING?

OH, NOT SO GOOD BILL, BUT I'M STILL HAVING FUN PLAYING WITH RADIO. HADDJ LAST NIGHT ON A LITTLE SET I BUILT. IS RADIO STILL YOUR HOBBY TOO?

NO, TOM. I'VE BEEN TOO BUSY MAKING GOOD MONEY OUT OF RADIO TO SPEND TIME "PLAYING" WITH IT.

GOSH, BILL, YOU'RE SURE LUCKY. I NOTICED YOUR SWELL CLOTHES AND SNAPPY CAR. I THOUGHT YOU HAD INHERITED A MILLION. TELL ME ABOUT IT.

I AM LUCKY, TOM, BUT YOU HAD THE SAME CHANCE. REMEMBER ABOUT A YEAR AGO I SHOWED YOU A BOOK FROM NATIONAL RADIO INSTITUTE THAT TOLD ABOUT THE OPPORTUNITIES AND BIG FUTURE IN RADIO, AND HOW OTHERS HAD SUCCEEDED THROUGH THEIR HOME TRAINING? REMEMBER, I TRIED TO GET YOU TO ENROLL FOR THEIR COURSE WHEN I DID.

WELL, IT WAS THE SMARTEST MOVE I EVER MADE. I'M DOING SWELL. MARY AND I ARE TO BE MARRIED NEXT MONTH. TOM, WHY DON'T YOU SNAP OUT OF IT? DON'T STAY IN THAT DREARY LOW PAY JOB ALL YOUR LIFE. RADIO IS MORE THAN A PLAYTHING. IT'S A BIG BUSINESS. IT'S YOUR OPPORTUNITY. TAKE MY TIP. IT ISN'T TOO LATE. RADIO IS STILL YOUNG AND GROWING.

IF BILL SUCCEEDED, I CAN TOO!

THEN I CAN MAKE REAL MONEY SERVICING RADIO SETS

OR GET A JOB IN A BROADCASTING STATION

OR INSTALL AND SERVICE LOUD SPEAKER SYSTEMS

OR MAKE GOOD MONEY IN ANY ONE OF THE MANY OTHER NEW AND GROWING BRANCHES OF RADIO. THERE'S NO END OF GOOD JOBS FOR A TRAINED RADIO MAN! YES, SIR, I'M GOING TO SEND FOR THAT FREE BOOK AND GET THE DOPE RIGHT NOW!

YOU CERTAINLY KNOW RADIO. MINE NEVER SOUNDED BETTER

N.R.I. TRAINING CERTAINLY PAYS. I JUST STARTED A FEW MONTHS AGO AND I'M MAKING GOOD MONEY ALREADY. THIS SPARE TIME WORK IS SWELL FUN, AND SOON I'LL BE ALL SET FOR A GOOD FULL TIME JOB

THANKS!

OH, TOM, IT'S WONDERFUL—TO THINK HOW FAST YOU'VE GONE AHEAD SINCE YOU WENT INTO RADIO. WE NEVER COULD HAVE GOTTEN MARRIED ON WHAT YOU WERE GETTING BEFORE.

OUR WORRIES ARE OVER. I'M MAKING GOOD MONEY NOW, AND THERE'S A BIG FUTURE AHEAD FOR US IN THIS LIVE WIRE RADIO FIELD.

... I will help you start a spare time or full time **Radio service business Without Capital**



Many Radio Experts Make \$40, \$60, \$75 a Week

The world-wide use of Radio sets has made hundreds of opportunities for good spare time or full time Radio businesses. Many of the seventeen million Radio sets are only 25% to 40% efficient. I will show you how to cash in on this condition. I will show you how to install and service all types of receiving sets in spare time. I'll show you how to make enough money while learning Radio to start your own service business. Clip the coupon. Get my free book, "Rich Rewards in Radio." Read how hundreds of N. R. I. men have made good money in spare time or full time businesses.

Many Make \$5, \$10, \$15 a Week Extra in Spare Time While Learning

The day you enroll I start sending you Extra Money Job Sheets which quickly show you how to do Radio repair jobs common in most every neighborhood. I give you plans and ideas that have made good spare time money—\$200 to \$1000 a year—for hundreds of fellows. My Course is famous as "the Course that pays for itself."

Get Ready Now for a Business of Your Own and for Jobs Like These

In just about 15 years Radio's growth has created over 300,000 jobs. Thousands more jobs will be opened by new Radio developments. Broadcasting stations use engineers, operators, station managers and pay up to \$5,000 a year. Manufacturers employ testers, inspectors, foremen, engineers, servicemen, buyers, for jobs paying up to \$7,500 a year. Dealers and jobbers employ servicemen, salesmen, buyers, managers, and pay up to \$100 a week. My Free Book tells about these and other opportunities.

Television, Short Wave, Loud Speaker Systems Included

There is opportunity for you in Radio. Its future is certain. Television, short wave, loud speaker systems, ship Radio, police Radio, automobile Radio, aviation Radio—in every branch, developments and improvements are taking place. Here is a real future for thousands of men who really know Radio—men with N. R. I. training. Get the training that opens the door to good pay and success in this growing industry.

Find Out What Radio Offers You

I am so sure N. R. I. can train you satisfactorily that I agree in writing to refund every penny of your tuition if you are not satisfied with my Lesson and Instruction Service upon completion. Get my 64-page book of facts. It tells you about Radio's opportunities; about my Course; what others are doing and making. Find out what Radio offers you. No obligation. **ACT NOW!** Mail coupon in an envelope, or paste it on a 1c postcard.

**J. E. SMITH, President
Nat'l Radio Institute, Dept., 5HX
Washington, D. C.**

Dear Mr. Smith: Without obligation send me the Service Manual and four free book about spare time and full time Radio opportunities and how I can train for them at home in spare time. (Please print plainly.)

NAME _____ ADDRESS _____ CITY _____ STATE _____ AGE _____

**J. E. SMITH, President
National Radio Institute, Department 5HX
Washington, D. C.**

HERE'S PROOF THAT N.R.I. MEN MAKE GOOD MONEY

"Made \$6,000 in 2 Years"

"Soon after the depression started, I found myself without a job, but I was well protected with N. R. I. training. I swung right to full time Radio servicing and I have made over \$6,000 in a little over two years."—Wm. Spartivent, Sparty Radio Service, 93 Broadway, Newark, N. J.



"\$500 a Year in Spare Time"

"Although doing spare time Radio work only, I have averaged about \$500 a year extra in addition to my regular income. Full time Radio work would net me many times that amount."—Edw. H. Fawcett, Slough Rd., Ladner, B. C., Canada.



FREE LESSON

ON PRINCIPLES OF TELEVISION RECEPTION

Yes,—I'll send you my Lesson "Electronic Scanners and Radiovisors," which covers the latest developments in Television. It explains the fundamentals of Cathode Ray Tubes, Beam Deflection, and Electronic Television Systems; including the Von Ardenne, RCA-Victor (Zworykin), Farnsworth systems. I want you to have this sample Lesson to prove to you how complete and up-to-date, yet how easy to understand my Training really is. **MAIL COUPON—NOW!**

MAIL THIS for FREE 64 page book

**- - - for the real
servicing "dope"
you can't find a
better book!**

NO other radio book is comparable to the new 1935 OFFICIAL RADIO SERVICE MANUAL. In contents, in style of printing, in grade of paper, in illustrations there has never been published such a comprehensive volume

The 1935 Manual contains over a thousand pages—yet it is only 1¼ inches thick because it is printed on a special Bible stock which is an exceptionally good stock, yet one of the thinnest and most durable papers. This 1935 Manual is the most authentic and elaborate service guide ever used in the radio industry. Service Men and dealers who use this 1935 Manual are astonished by finding in it such a wealth of profitable service information which has never been published before.

Contents of the 1935 Manual

- Over 1,000 pages full of diagrams and essential information of manufactured receivers—only data of real use in servicing is included. This new Manual is really portable since it is extremely thin and light as well.
- Volume V continues where the preceding manual left off.
- Many circuits of old sets are included.
- Service Men know every set has certain weak points which are really the cause of trouble. Wherever the information could be obtained, these weaknesses with their cures are printed right with the circuits. This is an entirely new and valuable addition to the Manual.
- All the latest receivers are included—all-wave sets, short-wave sets, auto-radio sets, midget and cigar-box sets, etc., as well as P. A. amplifiers and equipment, and commercial servicing instruments.
- The cumulative index is even more complete than before; including cross-reference to sets sold under different names and type numbers.
- Volume V includes resistance data; socket layouts; I.F. data; and voltage data.
- Tube data on latest tubes.
- Free question and answer service—as included in our latest three manuals.

OVER 1,000 PAGES

Over 3,000 Illustrations. Flexible, loose-leaf leatherette covers. Size 9x12"—only 1¼" thick

GERNSBACK PUBLICATIONS, Inc.
99 Hudson Street New York, N. Y.

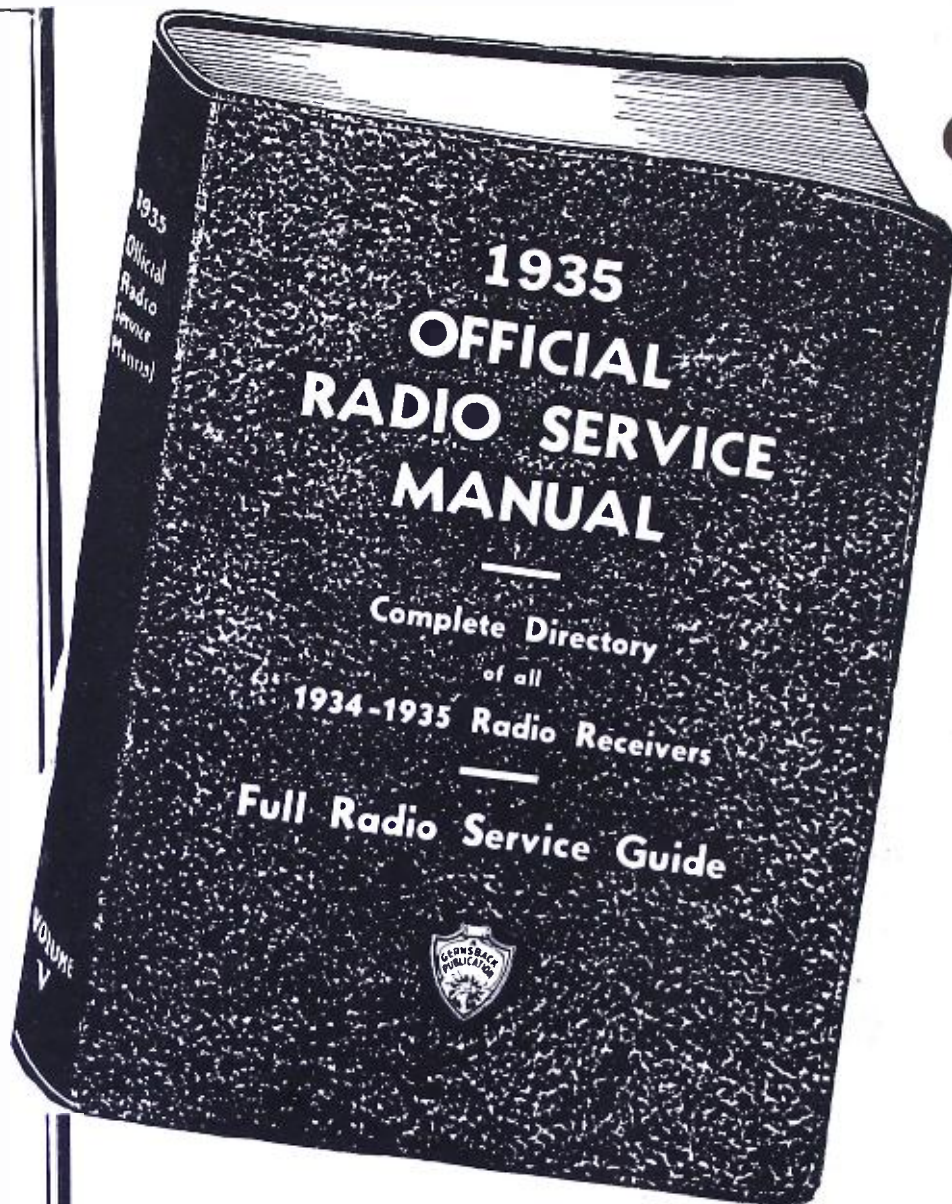

What Others Say about this Manual:

Norfolk, Va.
I received the OFFICIAL RADIO SERVICE MANUALS ordered as per my letter of March 20, 1935 in good order. I am very well pleased with same, as it is a very valuable Radio Service data reference and guide.
ARTHUR J. FREENEY.

Detroit, Mich.
Received your 1935 OFFICIAL RADIO SERVICE MANUAL and certainly is something to rave about. It's great.
A. HEDKE.

Stillwater, Maine.
I have received the 1935 Manual, and I am very much pleased with my investment.
FRANKLIN J. HOLMES.

Swift Current, Saskatchewan, Canada.
I beg to acknowledge receipt of my 1935 issue of the OFFICIAL RADIO SERVICE MANUAL. Your Manual is fine, and would not be without any of them. The Manuals may be improved for Canadian use.
A. M. FORD.

Kirbyville, Texas.
I was an original subscriber to the Gernsback Manuals and the magazine, RADIO-CRAFT. They have been a great pleasure and help to me.
H. K. WHITTINGTON.

Ironton, Mo.
I have lately purchased the 1935 OFFICIAL RADIO SERVICE MANUALS and sure am proud of same. Wish to say also, that RADIO-CRAFT Magazine is a lifesaver for service men. I would not be without either.
THOMAS J. MAYES.

CLIP-MAIL COUPON TODAY!

GERNSBACK PUBLICATIONS Inc., 99 Hudson St., New York, N.Y.
Enclosed find my remittance of \$7.00 for which send me, POSTAGE PREPAID One Copy of the 1935 OFFICIAL RADIO SERVICE MANUAL. [Send remittance by check or money order; or register letter if it contains cash, currency or unused U.S. Postage stamps.]

NAME.....

ADDRESS.....

CITY..... STATE..... RC-8-35

Please Say That You Saw It in RADIO-CRAFT



"Takes the Resistance out of Radio"

Editorial Offices: 99 Hudson St., New York, N.Y.

HUGO GERNSBACK, Editor

Vol. VII, No. 2, August, 1935

IS TELEVISION HERE?

An Editorial by HUGO GERNSBACK

A RECENT statement by the Radio Corporation of America that this company will release one million dollars or more for actual field experimentation in television during the next 12 to 15 months, is not only important but highly encouraging as well.

If the entire published report by the company's president, David Sarnoff, is read carefully, however, it becomes apparent immediately that television has, as yet, not arrived, and that it is not ready for the public at large. *Quite to the contrary*, Mr. Sarnoff placed considerable stress on the fact that television is still in the laboratory stage.

In my editorial in RADIO-CRAFT for February 1934, I made the following observations:

"The man in the street asks the question—and he asks it frequently—'what about television—what is happening? Is it true that our large corporations are deliberately withholding television on account of the depression? Has Television been perfected, etc.?"

"To these questions, it might be answered that none of our large radio companies are holding back television, nor has the art been perfected sufficiently to put it on a par with present-day home radio. All of our big radio interests have been toying with television; but whatever has been produced is still in the laboratory stage."

What I said a year and a half ago still holds true today. We are making progress all the time, but as yet, television is not for the public, it has not arrived, all the arguments to the contrary, notwithstanding. I must emphasize this point because not only the radio trade, but the radio public has in the past been grievously deceived as far as television is concerned. There has been entirely too much loose talk and too many half-truths which have seriously impeded the progress of the television art.

In my former publication, TELEVISION NEWS, I was forced to state in no uncertain language that *television in the past has been the football of irresponsible stock jobbers and manipulators who seized upon every little television improvement as a means to sell stock to a gullible public*. There has been in the past no cause to sell television stock to the public, and as far as I can see there is no excuse for it today. In other words, television still is very much in the laboratory—it is largely in the experimental stage.

DO NOT BE DECEIVED BY WHAT IS GOING ON IN EUROPE TODAY. There is nothing happening in England, Germany or France in television of any great moment as far as television is concerned. Whatever is being done in Europe now, has been done in the United States. Back in 1930-1933 we had the same types of television sets which they have in Europe today. Perhaps the images were not as large and perhaps they were not quite as clear, but the same methods were used. It is true that you can buy a television set in Europe today just as you could buy one in the United States in 1930-1933. It is also true that one of these European sets costs from \$250.00, upwards, but these sets will do nothing that the American sets would not do equally as well two or three years ago.

It is furthermore true, that the television engineer of today looks upon the cathode-ray tube as the ultimate solution of television. It is also a fact that some excellent television-type cathode-ray tubes are now made in Europe and equally as good tubes are produced here, but all of this does not spell television any more than the Bell tele-

phone receiver originally spelled universal telephone service throughout the nation.

From a perfectly personal standpoint, I have always felt—and I still feel so—and have said many times in the past, that in my opinion the cathode-ray tube is not the solution to television. To my mind, it is too complicated, and I am quite certain that the ultimate solution will not be the scanning cathode-ray tube which we have today. I again quote from my editorial for February, 1934:

"This scanning idea, to my mind, is all wrong, and totally unnecessary. When the final television invention comes along, one which may be likened to the radio tube of today as compared with the radio crystal of yore, it will be found that the scanning idea is conspicuous by its absence.

"Some thirty million years ago, nature invented the first real television machine which, so far, has not been duplicated by man. I refer, of course, to the animal eye, which has been in existence on this planet for millions of years, and is open for study by all television aspirants.

"The animal eye (which, of course, includes the human eye) is almost a perfect television receiver and transmitter. Not only does it receive an image from the outside world by means of light rays and then transmit it through the optic nerve to the brain, but it goes the television engineer several steps better; because in the first place, the eye gets along marvelously well **WITHOUT ANY SCANNING MECHANISM**, but the image is received and transmitted in colors as well."

But even with an entirely new television invention, greatly simplified over the cathode-ray tube, television still will not be an accomplished fact. We still must rebuild our entire broadcasting structure, for the following reasons:

Authorities are all agreed upon one thing, and that is that television will be emitted over the ultra-short wavelengths (somewhere below 6 meters). These impulses do not go beyond the horizon. That means, the entire country will be dotted with literally thousands of television transmitters, giving service *locally*. These transmitters will be linked together in a nation-wide hookup by a new cable recently invented, and termed "concentric transmission lines" (and discussed elsewhere in this issue). This also means that the present broadcast wavelengths for *sound*, from 200 to 500 meters, will eventually be scrapped.

The only sensible plan for future television will be to have the audible (sound) broadcasts, also sent by ultra-short waves, in which case the present broadcast stations become obsolete, *because both audible programs and television programs must go over a single wavelength*. (This, by the way, has already been accomplished—back in 1932 the Columbia Broadcasting Company transmitted both sound and television over the same wavelength!) This arrangement is absolutely essential because the ultimate user will not stand for tuning in a sound program on one wavelength and then tuning in his television program on another wavelength. Instead of having a multiplicity of controls (that is, tuning in for sound and then tuning in for television), the public will tune in on a single wavelength just as it does today, with the difference that it will get, simultaneously, sound *and* television.

THE RADIO MONTH

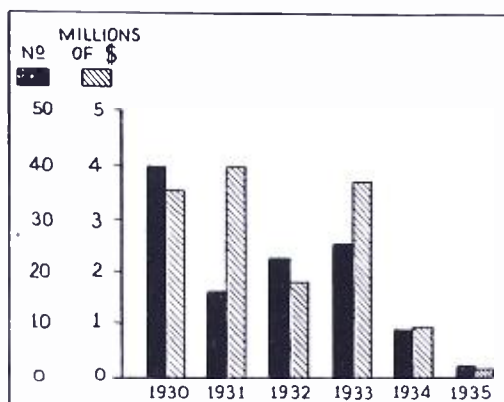

Here is the encouraging reduction of business failures in the radio manufacturing industry. (The figures for 1935 represent four month's business.)

DUN & BRADSTREET SPEAKS AGAIN

FROM time to time, we have printed excerpts from reports on the condition of the radio business made by the world-famous firm of Dun and Bradstreet.

Last month, another very encouraging report appeared, as reprinted, in part, below.

"Perfection of the short-wave sets and progress made in the development of radio sets for motor cars forced some manufacturers to increase their output from 75 to 300 per cent above that for the first quarter of 1934. Sales in nearly all parts of the country have expanded, the increases running all the way from 15 to 70 per cent, in spite of the fact that demand generally during the opening months of the year usually is nearly one-third less than during the third and fourth quarters.

"A particularly encouraging phase of this year's sales has been the higher profit margin because of the trend toward the larger and more expensive models (ranging from \$300 to \$1,000).

"Although sales of automobile radio sets in 1934 established an all-time high, the increase over that record thus far this year has ranged from 20 to 40 per cent, with the gain in some districts as high as 75 per cent.

"The total of failures for manufacturers and wholesalers and retailers of radio equipment in 1934 was reduced to 46, the fewest recorded for any year in the industry's history. During the first four months of the current year only 2 failures were listed for manufacturers and 19 for wholesalers and retailers."

And from another source—the annual chart of the International Broadcasting Office in Geneva, Switzerland—we learn that there were 48,300,000 radio sets in the world at the end of 1934, 20,750,000 of which (more than 40 per cent) were in the U.S. which means that there were 162 sets per thousand population.

IS RADIO'S VOICE GAGGED?

A HEATED controversy was started last month by Col. R. McCormick, publisher of the *Chicago Tribune*, who warned other newspaper interests that they would have to fight to the last man against Government control of the press—and particularly against the newspaper publisher's code, under the NRA, which he termed a "wedge" to allow the administration to suppress the "free press."

As an example, Col. McCormick pointed out what he called the "radio censorship." He said—"I refer to the radio and the fashion in which it was silently but surely brought under the control of the administration. . . . Licenses are granted for only six months; the axe of execution overhangs the head of every station."

In rebuttal, M. H. Aylesworth, head of the NBC, emphatically denied the truth of these accusations, as did A. J. McCosker, former president of the Association of Broadcasters and head of the Bamberger Broadcasting Service, Inc. Mr. McCosker stated—"Such an accusation is entirely unjustified. . . . Radio broadcast stations have, without interference from the F.C.C., allotted equal times to speakers in opposition as well as those favoring the policies of the administration."

F.C.C. MOVES TO CLEAR THE ETHER

FOLLOWING our report last month of the activities of the Women's National Radio Committee to improve the standards of programs sent out over the air-ways, and the cooperation offered by the Federal Communication Commission through the efforts of its chairman, Anning S. Prall, came first, a statement in the papers by William S. Paley, president of the Columbia Broadcasting System that the amount of time permitted for advertising would be definitely limited.

Secondly, the F.C.C. made its first step toward "clearing up the ether" by summoning 21 stations, some of which are nationally prominent, to "prove that their continued operation will be in the public interest."

This action was started, according to the Commission "for the most part, because the stations at various periods carried a program entitled 'Marmola,' a preparation represented to reduce fat." That preparation has been banned by the Postoffice Department.

All of which can be traced indirectly to our fair friends of the Women's National Radio Committee!

NOW—A MARCONI "DEATH RAY"

SENATOR Guglielmo Marconi's name appeared in the news again, last month; this time linked with an invention which has just been demonstrated before Premier Mussolini. The invention is in the form of a machine for producing "death rays" and according to a dispatch from the *London Daily Mail*, all automobiles on a mile-long stretch of the road between Ostia and Rome unaccountably stalled, when the demonstration was made.

Regarding the "death ray invention" Marconi said—"It is absolutely impossible for me to describe this invention now or even whisper its importance or implications."

So many "death ray" machines have been rumored in the past, that one is inclined to either take such news as absolutely false, or to pass it off as gross exaggeration. However, when a name as well known as Marconi's is linked with it, the news must be taken more seriously.

TELEVISION HOOK-UP FROM N. Y. TO PHILADELPHIA

AT ABOUT the middle of last month, a report was received from the Federal Communications Commission granting permission to the American Tel. & Tel. Co., to install a coaxial cable between New York and Philadelphia for experimental purposes. (The German government gave Telefunken an order last year for an 8-mile coaxial cable for television!)

It will be remembered that we announced some months ago the possibilities of this new type of cable for television. It comes as no surprise, therefore, that an actual cable is to be installed, especially since the announcement by one company that a million dollars would be spent in the next year on television "field experiments."

The projected New York-Philadelphia coaxial cable for television includes "talking" wires.

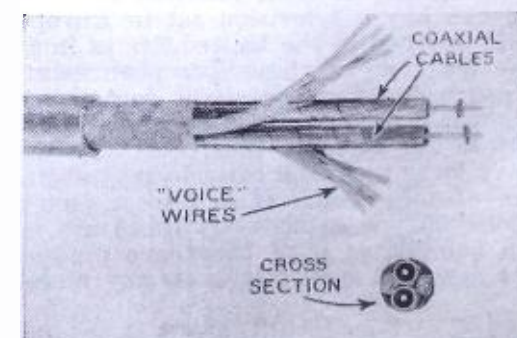

IN REVIEW

Radio is now such a vast and diversified art it becomes necessary to make a general survey of important monthly developments. RADIO-CRAFT analyzes these developments and presents a review of those items which interest all.

NEWS BROADCAST BOMBSHELL EXPLODES

THE prediction we made last month about trouble in the news broadcasting situation came about in rather a different way than we anticipated. Instead of the newspapers cracking-down on the stations as expected, another news gathering company—Transradio Press—brought suit against the two large radio networks and their affiliates in the newsgathering field, in an attempt to break up the present agreements so that they (Transradio Press and its partner Radio News Association) may gain access to these two chains in vending their "news."

It all sounds rather complicated, but we must await the result of the law proceedings, for the answer.

PLANE CRASH DUE TO DEFECTIVE RADIO

A CRIPPLED radio set, a blinding fog and a dwindling gasoline supply were the reasons set forth by a coroner's jury as the explanation for the crack-up of the TWA luxury air liner "Sky Chief" last month, in which Senator Bronson Cutting and four others lost their lives.

The fact that a defective radio transmitter and receiver are charged with the blame makes this tragic story more interesting, since TWA prides itself on making a thorough check-up of every "ship" after each flight.

Yet a reading of the pilot's log at the coroners inquest presented such facts as "radio transmitter failed"—"two-way receiver weak"—"radio will not work in night frequency"—"transmitter spasmodically goes out" indicating that the radio equipment gave trouble soon after it left Los Angeles.

It seems inconsistent that a plane so disabled should be allowed to continue a flight, especially into heavy fog, when it could have been landed safely at Wichita, Kansas.

Eleven (and more) TWA experts can simultaneously service every part of one of the "luxury" liners.

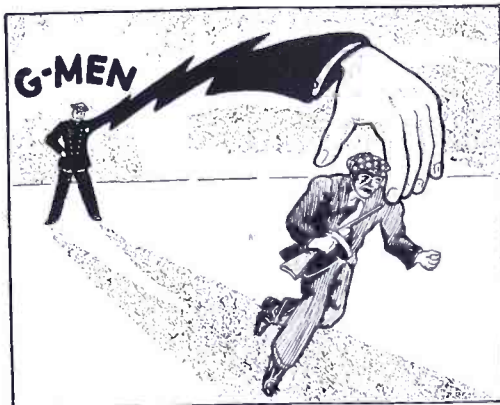
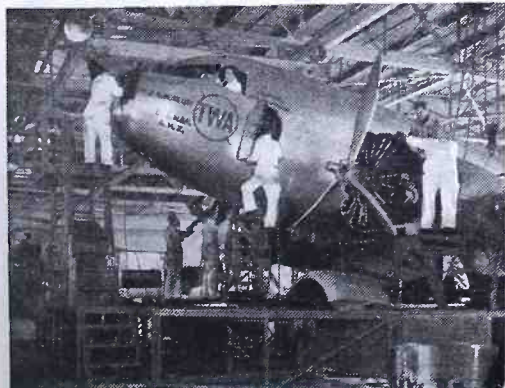

The long arm of the law is made even longer!

SECRET RADIO SYSTEM FOR G-MEN

THE long arm of the law was made even longer last month with the inception of a secret (?) radio system for the Department of Justice—to aid them in their efforts against kidnapers, robbers and other criminals.

The plan calls for a central broadcast station with the country divided into reception zones with headquarters in 32 cities, as well as mobile units in fast automobiles and planes.

In addition, it was pointed out that the "G-men" can tie in with local municipal police systems whenever a wide search must be made over a certain locality.

NEW SHIP-RADIO DEVICE

A NEW system of radio communication on ship-board, by which the captain may talk to any or all persons on board, was demonstrated last month on the *S.S. Colombian*.

The system, which was invented and perfected by Dr. F. L. Satterlee is a two-way device so that the captain, for example, can converse with the engine room and receive an immediate reply. It uses the hull and other metal parts of the ship, instead of the usual wires required for telephone conversation. Loudspeakers attached to these metal parts pick up the messages sent from the bridge. By means of a series of switches in a small control box the captain is able to "tune in" on all parts of the ship. There is also a general alarm switch that enables the officer on the bridge to tune in on all state-rooms at the same time.

It is understood that this device is to be installed on all the ships of the Colombian Line. In our opinion, this is a commendable decision. The installation of equipment of this type will help to prevent a recurrence of such tragedies as the Morro Castle fire.

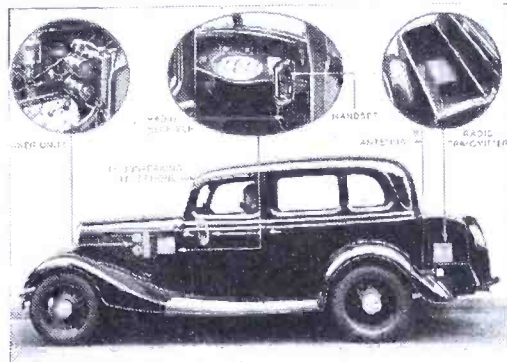

Western Electric Co. photo

This police car has a transmitter, and a receiver which can be used as a P.A. system.

NEW POLICE RADIO CAR EQUIPMENT

THE latest development in police communication was announced last month by a large manufacturer, the first installation of this system being made in Evansville, Indiana.

The system operates on ultra-high frequencies. The transmitter which has an output of 5 W. is accurately held to its frequency by a quartz crystal.

The receiver is equipped with a powerful A.F. amplifier and may be used as a P.A. system, to announce over its loudspeaker messages broadcast from headquarters or instructions originating in the car itself.

PHONO RECORD FIRM LOSES SUIT

A RATHER interesting law suit came to a conclusion last month, in Budapest. The British Gramophone Company sued the Hungarian State Broadcasting System for a monthly payment of \$6,000 because of the constant use of records for broadcasting which are produced by the "Gramophone" company.

The Hungarian Supreme Court, however decided that the broadcasting of phonograph records by radio companies did not require them to pay royalties on the records.

This decision brings to mind the situation in this country, in which a very sizeable business is maintained by producers of records out of just such royalties.

It also brings to mind recent happenings in the motion-picture field. By a series of contract terminations and legal actions, many of the theatres in the U.S. are now having their "sound" equipment serviced by independent Service Men or by their own service organizations. This change has opened up over 5,000 theatres for the independent Service Man to service—a lead worth following, for many Service Men.

RADIO PICTORIAL

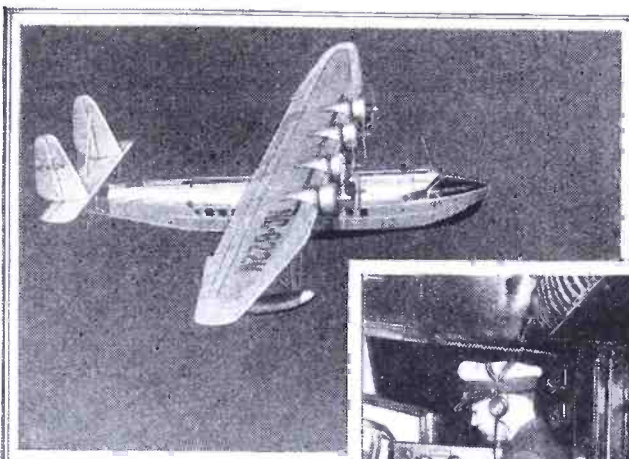

Left, the "Brazilian Clipper," giant plane weighing 19 tons, is 68 ft. long; has a wing spread of 114 ft. It can span the Atlantic or Pacific. The "radio shack" of a clipper ship is shown at the left below.

At the right are shown some of the radio amateurs who will keep the California Exposition in touch with the world wide "hamdom."

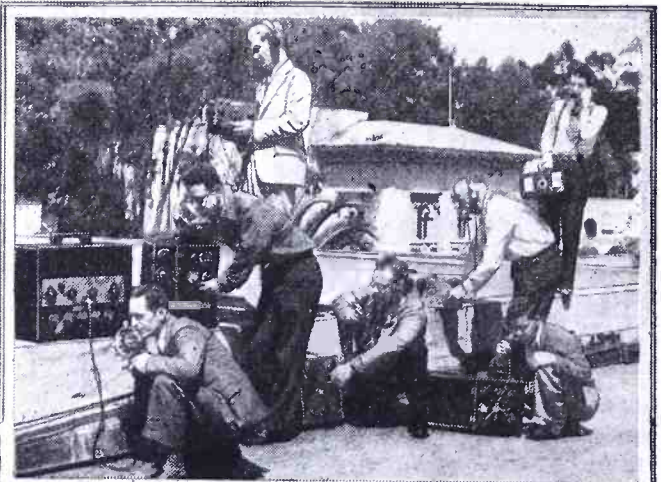

Below, A \$5,000 control panel in "Victor" London studios, used for making Jubilee records of events and music of King George's reign.

Globe Photo



Stratosphere gondola.

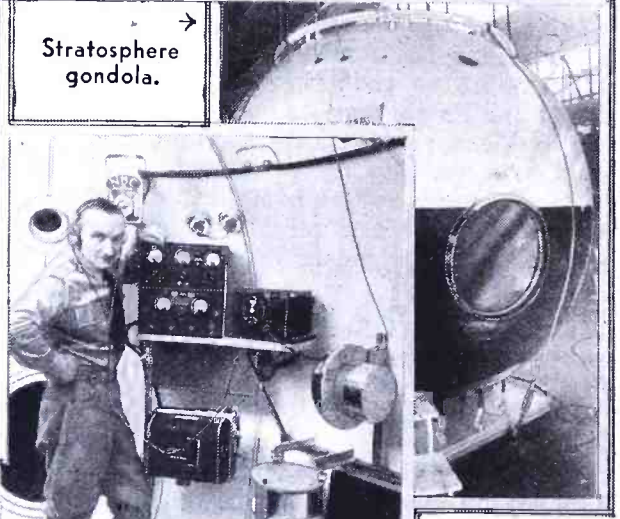

English "high-power megaphone."

Globe Photo

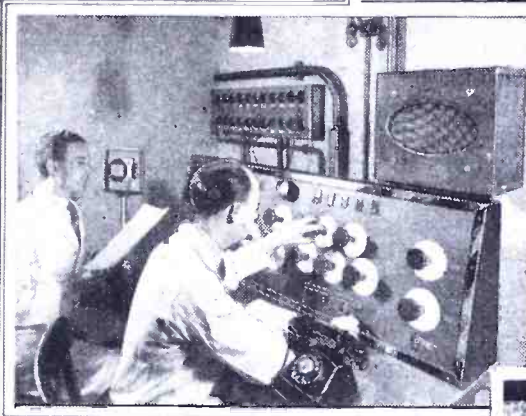

A new "radio weapon detector" shown below. Three concealed loops unbalance as metal enters field and sounds alarm, at RCA labs., Camden, N.J.

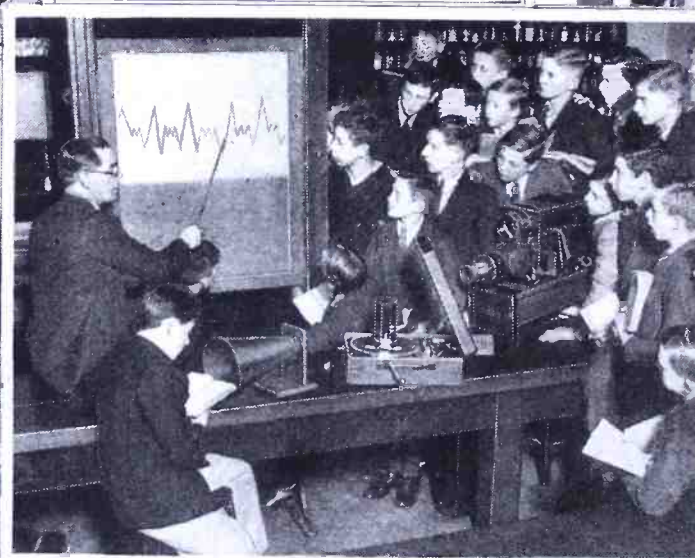

An English method of improving students' diction.

Voice sounds are converted into light rays and thrown on a screen as shown by wavy line above. This "Phonodeik" uses a rotating-mirror scanner, spotlight, and diaphragm. The two photos at the right show details of an audible level indicator and talking robot for P.A. and broadcast work. It automatically announces "too high" or "too low" and by a record and 2 pickups it repeats until operator adjusts amplification.

network rebroadcast a description of the flight directly from the balloon.



Recording sounds on endless steel tape 81 ins. long and 0.0015-in. thick, shown at right. It will play back the sounds instantly like an echo. A signal light warns when to stop talking.



Above, Bell Telephone Laboratories Photo

Lower right photos by Halbran





Left, Chief Operator Martin adjusting a channel of the new \$500,000 short-wave radio installation at the Waldorf-Astoria Hotel.

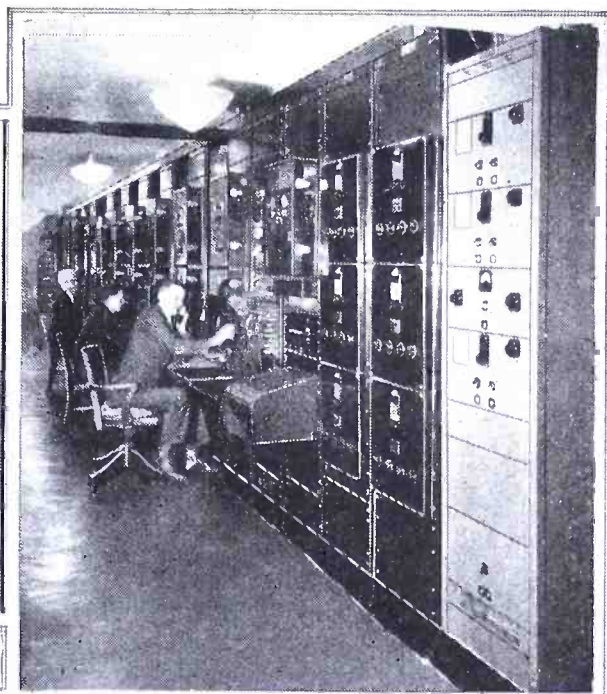
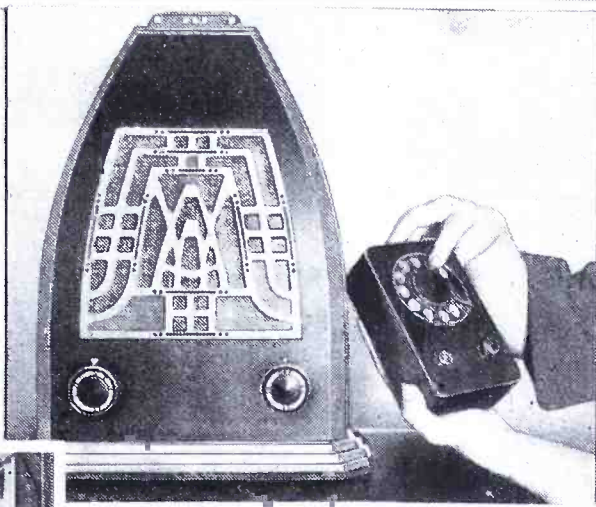

↑ The most expensive all-wave receiver in the world is pictured here at the sides and top. It serves 2,200 suites at the Waldorf-Astoria Hotel. Each suite has a speaker and dial box. A guest can dial a local or foreign station or even a phonograph record at will. The unusual dial system and speaker is shown above. At the top right is shown the extensive array of equipment used in this gigantic receiver. Three master S.W. receivers supply the short-wave programs to all rooms. Photos by Halbran →

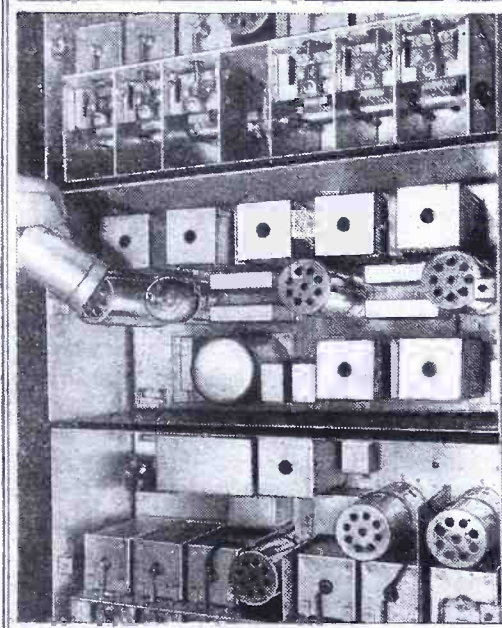

↑ Radio in motorcycles for English police.



↑ This is Egbert, the electrical robot at the Benjamin Franklin Memorial, Phila., Pa. It is used to welcome visitors to the hall. A phonograph is the source of Egbert's voice and a relay under him operates a motor which raises and lowers his arm. A loud-speaker is located in his chest, and is the outlet for his voice. P.E. cells are connected to relays so that a person entering the building will set the mechanism in operation. Egbert tells you to have an enjoyable visit at the exhibition hall.

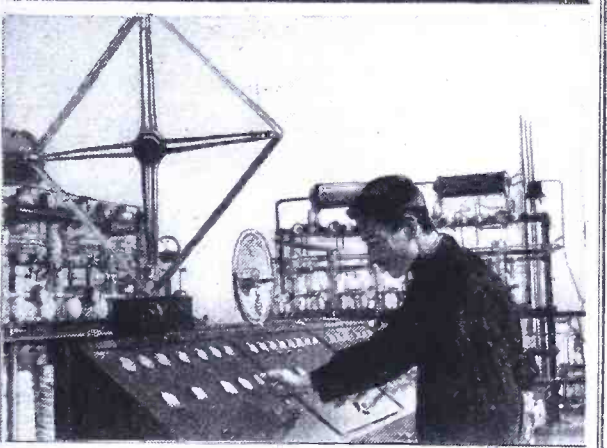

↑ Weighing only 10 lbs., U.S. Army "transceiver" has reliable range of 4 miles ↓

↑ Control room of 500 kw. station Kominturn U.S.S.R.



↑ Radio music increases egg production 20 per cent! A P.A. system produces music from morn till night, at Arndt's experimental hatchery, Mercerville, N.J.



PRESENTING— THE MULTIPLE-IMAGE TELEVISION RECEIVER

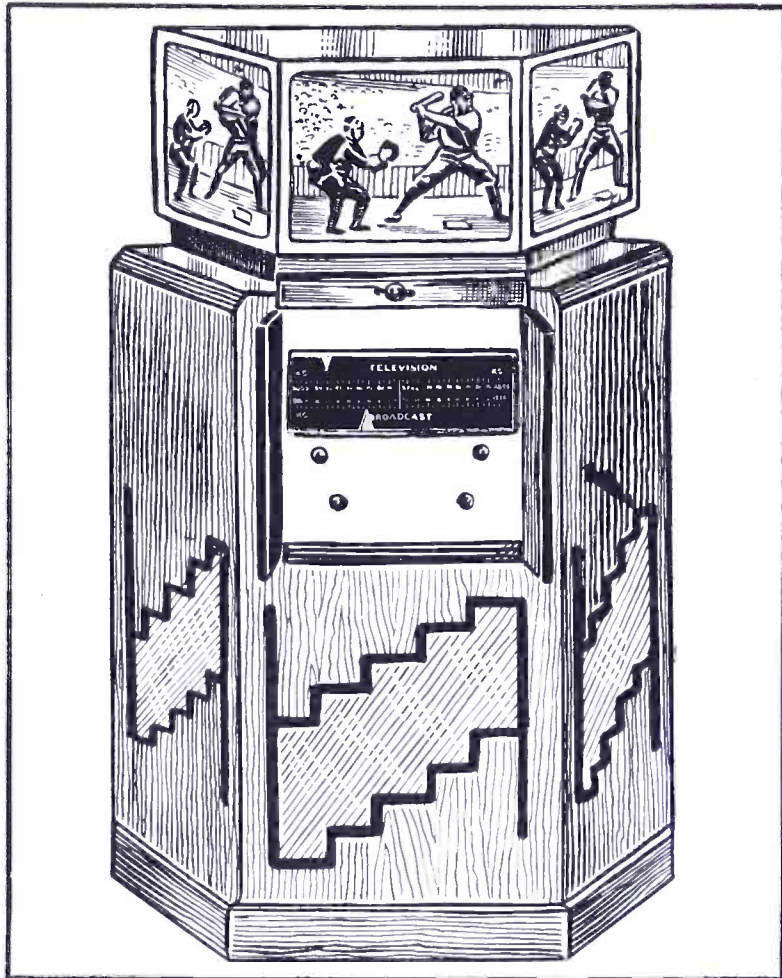

HUGO GERNSBACK

What television needs is a receiver that can take image reception out of the "head-phone" class and give it "loudspeaker" performance. The author, editor and publisher of his former "Television News" magazine, secures this "group coverage" by using three screens in a television receiver of radically new design.

clear enough and intense enough for the onlooker sitting or standing right in front of the screen in order to view the television image. No thought was, or has been given, up to now, to make television as universal an instrument as the radio set. As I mentioned above, when you listen to a radio program you don't have to sit in front of the set, you can be behind it or on the side of it. Not so with television, because light rays do not happen to spread out like sound waves but are propagated only in straight lines. Therefore, we have the exceedingly silly arrangement which has been persisted in by constructors ever since the first television set was built; that in order to view a television program, you must stand or sit right in front of it. If you move too much to the side or at right angles to the screen, you see nothing. If you have ever witnessed a television demonstration, or if you have ever had a television set in your home, as the writer had in the past, and there are many people in the room, you will get the result of a lot of persons crowding behind each other, craning their necks and bending every which way in order to get a view of the screen.

This idea is perfectly sane in a motion picture theatre, for instance, where the seats are arranged in such a manner that the person in front of you does not obstruct your view, that is, if the person in front of you is not too large. If he is, you must shift your head to the side to see the screen.

But take television in the home. Can you imagine that in the future people will all wish to sit in front of the television set in order to see what is going on? No one can imagine such a thing. It has always been a mystery to me why television engineers have never thought of the idea of *multiple image television* in order to make the television program accessible in every part of the room, no matter where you sit. You will see, therefore, that the idea which I suggest herewith (which I believe is shown here for the

(Continued on page 102)

WHEN radio broadcasting took the world by storm in the early twenties, we listened in to our programs by means of telephone head receivers, more popularly known as earphones. This was satisfactory only when a single person wanted to listen in. Soon, it was found that more than one person often decided to listen in to the same program, so all sorts of gadgets made their appearance whereby two, three, and as many as six sets of phones could plug into these gadgets to make it possible for the entire family to listen in.

It took quite a few years to develop the multi-tube sets and loudspeakers, and then headphones were no longer of interest to the public. We now have our loudspeakers emitting sound waves which have the property to permeate an entire room; this makes it possible for anyone in the room to listen to a single loudspeaker whether he is sitting in front of it, to the side of it, or behind it.

When television first came about, engineers were more concerned, and are still concerned, with producing an image

(B) This future scanner functions like our eyes.

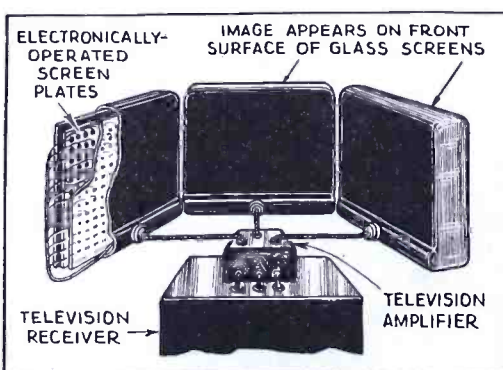

(C) Indirect multiple projection using a new means.

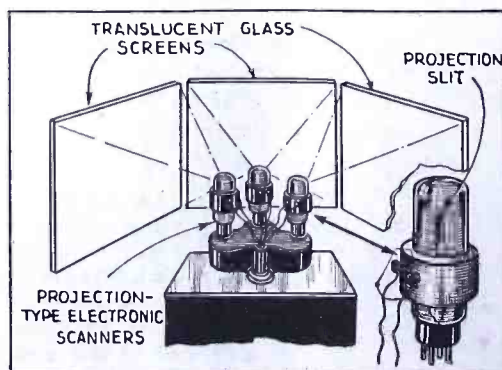

(D) A multiple-element tube for direct projection.

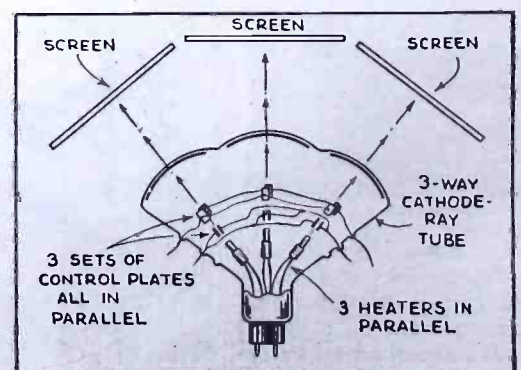

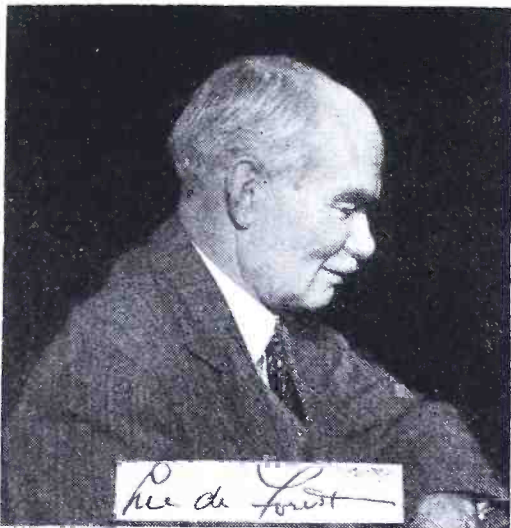

TELEVISION PRESENT AND FUTURE

The television situation is summed up in the two statements made below, expressly for *Radio-Craft*, by leaders in the field.

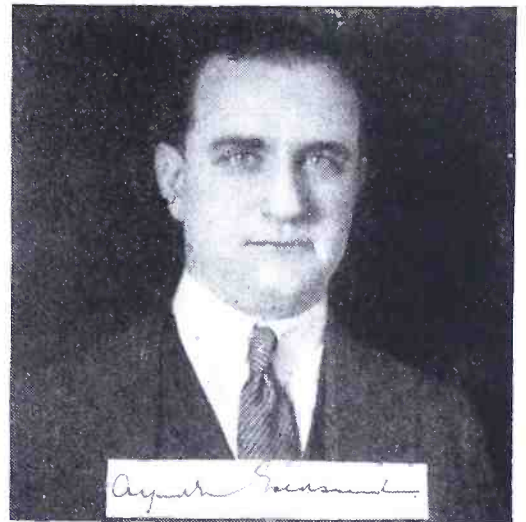

DR. LEE DeFOREST SAYS—

"IT IS not to be questioned that an enormous amount of very careful research and development in television for the laboratory has been carried on in the United States during the past 3 years. Much of this work will prove useful hereafter in actual television in the home.

"Unfortunately the above statement cannot, in my opinion, be applied to all of the work which has been carried on in this country, England and Germany at terrific expense. In my opinion the inherent limitations of the cathode-beam tube will prevent its general acceptance by the public. The combination of an acceptably large picture, brilliant illumination and long life of the tube are irreconcilable; at least until someone has discovered a fluorescent layer of an entirely different order from anything known in the cathode-beam art today.

"However, a mechanical scanner has been developed which is small, noiseless, cheaply (Continued on page 102)

DR. ALFRED N. GOLDSMITH SAYS—

"TELEVISION is still partly in the research and development stage. Nevertheless sufficient progress has been made to indicate many of the main lines of its practical application.

"Clear pictures of moderate dimensions and adequate detail can be transmitted and received although the equipment at both ends of the circuit is elaborate and more costly than that required for present-day broadcasting.

"Television development will proceed at a moderate pace in an orderly way during the next decade. Starting with individual stations in the largest cities, there will be an increased number of such stations until many millions of lookers receive adequate service. The interconnection of these stations into networks will follow in due course. In brief, television development will be steady but its cost is such as to limit the speed at which it is practicable to establish a nation-wide service."

"FREQUENCY" VS. "AMPLITUDE" MODULATION

The new "frequency" modulation system just announced by "the" Armstrong of regeneration, super-regeneration and superheterodyne fame, offers amazing advantages to (1) television, and (2) high-fidelity broadcasting—especially, on 5 meters and less.

EDWIN H. ARMSTRONG

ANEW and revolutionary system of radio transmission which wipes out the effects of static, tube noises, and fading, has been invented by Major Edwin H. Armstrong (as announced last month on page 6) and is described briefly below.—*Editor*.

Modulating and multiplexing equipment at the Empire State transmitter.



The principle is carried out by the use of a discarded method of modulation known as *frequency modulation*. Although this method of modulation has been known for over 20 years, the hitherto unsurmounted difficulties due to distortion and other troubles in both transmitter and receiver have caused its abandonment by all who worked with it.

The original demonstrations of the system were made at Columbia University in the beginning of 1934, where, it was explained to some of the leading engineers of the country. As a result of these demonstrations, the short-wave transmitter on the Empire State building was placed at my disposal by the National Broadcasting Co. about a year ago.

Tests have been continuous but so secret that our work passed unnoticed,

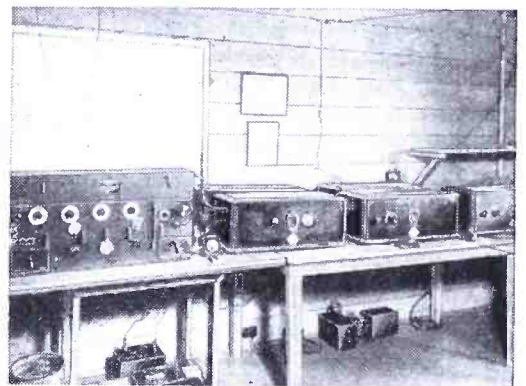

Part of the receiving station at Westhampton, L.I. (Amateurs unequipped with suitable receivers reported, "Fix your apparatus—modulation is poor"!)

except by amateurs who being unequipped with proper receiving equipment, frequently advised the engineer in charge of the station to find out what was "wrong" with his transmitter!

Although the power used at the Empire State transmitter was under 2 kw., at no time during the last year either at Westhampton or at Haddonfield (where the receivers were located) were the programs interrupted by either static or fading. On the other hand, in the summer time it was frequently impossible to listen to either of the 50 kw. stations WJZ and WEAJ on account of the static.

In the winter time the selective fading frequently interrupted the programs almost as badly as static in the summer time. *Neither occurred with the new system.*

The amount (Continued on page 102)

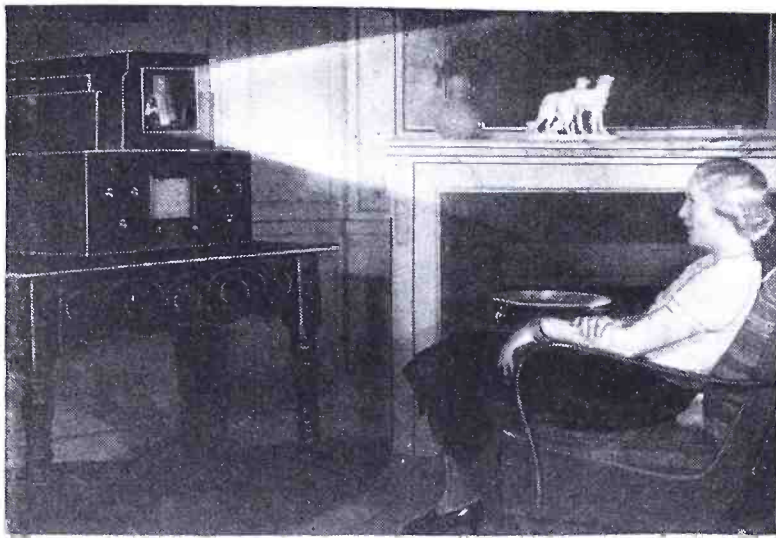

WORLD-WIDE TELEVISION

Television is gaining international momentum. This well-illustrated article supplements articles in preceding issues of **RADIO-CRAFT**, describing the various systems.

**R. D. WASHBURNE
AND
WILHELM E. SCHRAGE**

TELEVISION, which has been in the throes of an exaggerated case of sleeping sickness, appears now to be yawning and getting ready for a stretch to its full height. International interest appears to be aroused (see Fig. 1), with each country sponsoring a pet television scheme of its own (many of which are government owned). Consequently, the foresighted technician and business man finds himself quite "at sea" as to the status quo of the various systems advocated in the several countries that are foremost in this field. The following description and accompanying illustrations have been prepared with the idea of presenting a working cross-section of television today throughout the world.

CANADA

Peck Television Co. of Canada, Ltd. Field strength measurements have just been completed, preparatory to maintaining a regular television schedule on 50 to 54 megacycles over station VE9AK, Montreal, Canada; transmission is *high fidelity*, 180 lines, 24 pictures per second. Programs at present utilize the film scanner shown in Fig. 2 (studio scanners and direct pick-up cameras for outdoor work are expected to be in operation, shortly); the receiver illustrated in Fig. 3 is a demonstrator type incorporating an all-wave voice-program receiver and a 50-54 mc. image receiver. (It is claimed that two beam antennas will permit 75 per cent coverage of the Dominion.)

Fig. 1. The status of television in Europe is indicated on the map. (It is interesting to note that "coaxial cable," used in Berlin television experiments since 1931, would permit the Berlin television station to supply 20 remote television stations—see page 126—with high-fidelity picture impulses; the cost then for local high-quality scanning equipment, amplifiers, etc., would be practically nil.—Editor.)

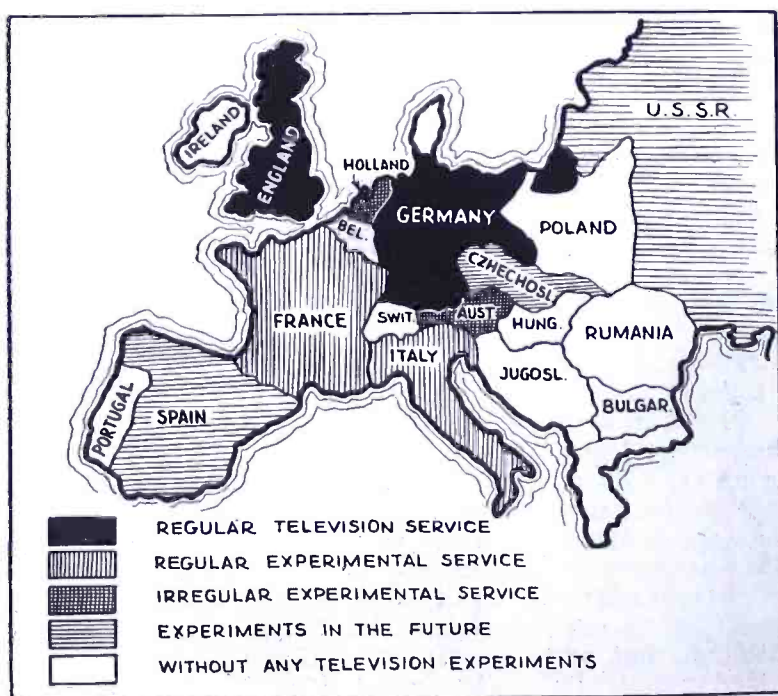

UNITED STATES

The State University of Iowa, Iowa City, Iowa. Station W9XK, (on 2,050 kc.) operated by the Electrical Engineering Dept. of this institution, is being utilized for the sight-sound transmission of lectures by the faculty—on the basis, we understand, that man learns 83 per cent through his sight and only 13 per cent through his hearing faculties. The equipment is illustrated in Figs. 4 (farthest left) and 5. Station W9XK uses a 45-hole, triple-spiral disc, rotating at 900 r.p.m.; the 4-lens turret can be seen in Fig. 5, within the ring of 10 photoelectric cells. An interior view of the receiver is Fig. 4 (An exterior view of a similar type of set is shown in Fig. 11.) Power-line synchronization is used—243 towns and cities are tied into the Iowa City power network. Accompanying sound goes over station WSUI, on 880 kc.

Kansas State College of Agriculture and Applied Science, Manhattan, Kan. For three years the Electrical Engineering Dept. of this college has been active in television research, and operates station W9XAK, on 2,050 kc. The flying-spot system is used (See Fig. 6),—60 holes at 20 frames per second. The antenna power is 125 W. Receiver incorporates a Kerr cell, and either lens disc or mirror-screw, images up to 1 foot square being demonstrated; a superhet. circuit is used, with controllable I.F. characteristics. (Development work is progressing on a new type of scanning system for the receiver.)

Northwestern Television Inst., Inc., Minneapolis, Minn. The Institute operates station W9XAT, on 5 to 7 meters. The transmitter incorporates a 45-line, triple-spiral pinhole scanning disc mounted directly on a 900 r.p.m. synchronous motor; thus, a 45-line, 15 frame picture is produced. A bank of 8 parallel-connected photoelectric cells is used, as shown in Fig. 7; (additional views of the equipment appear in Figs. 34, 35 and 37).

The students of this school have constructed several 2-unit superhet. receivers incorporating the "acorn"-type tube.

First National Television, Inc., Kansas City, Mo. This organization operates station W9XAL, on 2,750 to 2,850 kc.; power rating is 500 W. High-fidelity sound is transmitted over W9XBY, on 1,530 kc., at 1,000 W., in synchronism with the sight over W9XAL. The latter station also is licensed to transmit on 42,000 to 56,000 kc., and 60,000 to 80,000 kc., with 150 W. A cathode-ray scanner for use in conjunction with motion picture film is under construction.

Ultra-short-wave transmission is very effective from the top floors of the skyscraper offices, shown by insert in Fig. 8, which is an action view of the television studio. Figure 9 shows the television and sound control room; Fig. 10, the high-fidelity sound transmitting equipment of W9XBY. A domestic scene in the service area of W9XAL is shown in Fig. 11.

Farnsworth Television, Inc. A description of the latest type of commercially-available Farnsworth television receiving apparatus is described elsewhere in this issue of

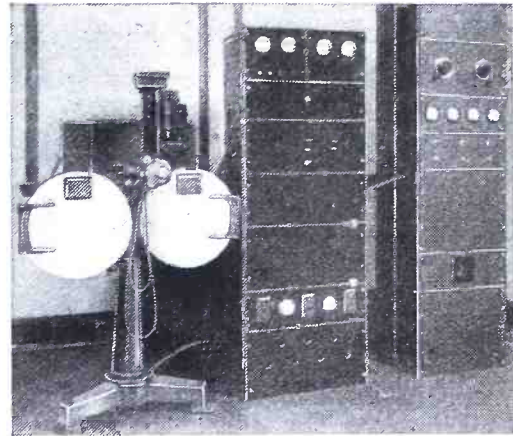
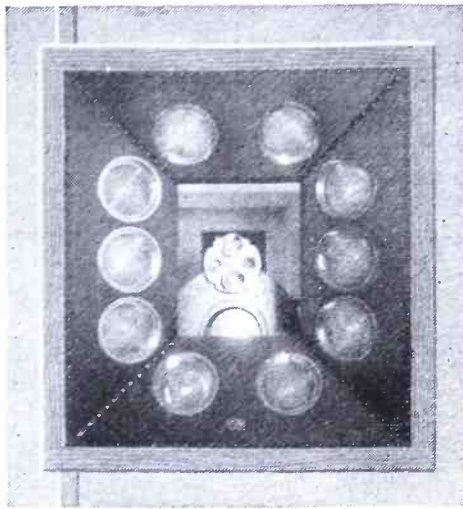
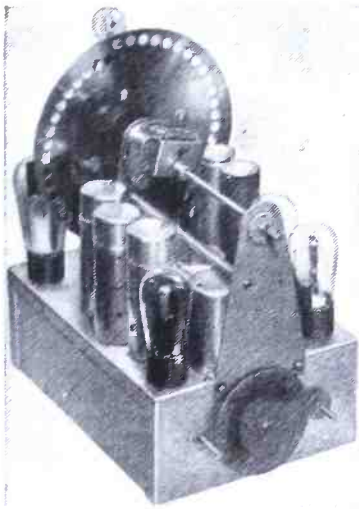

Figs. 2 and 3, above. Canadian television equipment.

Figs. 4 and 5, left. Equipment for W9XK television pick-up and reception.

Radio-Craft. Announcement has just been made to the press, by this company, that within a few months an experimental station will be in operation utilizing a new "multipactor" tube in the Farnsworth system of transmission and reception, on regular schedules.

JAPAN

Institute of Technology of Tokio. Television activities in the Land of the Rising Sun are at present concentrated in the hands of Prof. Kenjiro Takayanagi, who has developed his own system consisting of a combination Nipkow disc scanner in the studio, and a cathode-ray type of image reproducer at the receiver. This experimental station works with 80 lines, 25 pictures per second. Figure 12 includes an inset (A) of a Japanese symbol as received during one of the tests; a regular image view also is included. Figures 13, and 14 are additional views of the equipment.

ENGLAND

British Broadcasting Corp., London, Eng. Figure 15 illustrates the studio setting for television presentation of "Cleopatra"; this drop faces toward the control room (inset). The control room is shown in better detail in Fig. 16; while Fig. 17 shows a "television performer."

Baird Television Co. This is the oldest television company in England, and cooperates with the British Broadcasting Company. In Fig. 18, Mr. J. L. Baird is shown with one of his latest receivers; in Fig. 19 is illustrated a Baird "cine-television" camera which takes a picture, develops the film, dries

and fixes it, and televises the picture to the receiver miles away, all within 30 seconds!

In general, all English television receivers on the market have facilities for varying between 100 and 500 line image reproduction; and picture frequency can be varied from 10 to 50 per second.

FRANCE

Ecole Superieure des P.T.T. Monsieur M. Barthélemy is the guiding genius of television in this institution, and is responsible for the present stage of development of television in France. Until recently two experimental stations have been in use—one in Lyon working on 215 meters, and one in Paris working on 135 meters. A 60-line image, 25 pictures per second, is transmitted.

Figures 20 and 21 are two views taken in the Paris studios of the French television system. Figures 22 and 23 illustrate the inaugural program last April of the P.T.T. Paris station mentioned above.

GERMANY

There are at present five companies in Germany manufacturing television sets. Four of them have cathode-ray models, with a picture size from about 4 x 6 ins. (and selling for about \$300.00), up to 10 x 12 ins. (list price, \$600.00). The remaining, fifth company (Tekade) sponsors the mirror-screw type of scanning equipment; the 180 tiny mirrors on the spindle resolve the image screen into 180 lines—high-definition television.

Fernseh, A.G. Details of the "television truck" of Fernseh A.G., used by the

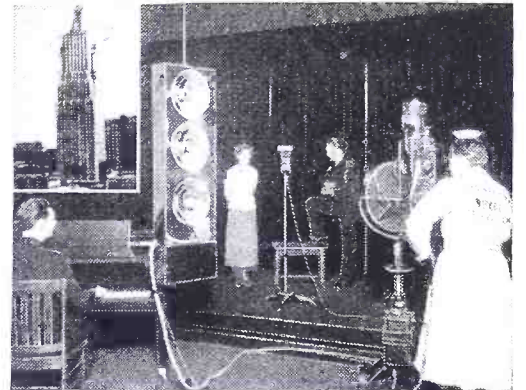

Fig. 8. Television on ultra short waves from W9XAL is illustrated. Synchronized sound goes over W9XBY.

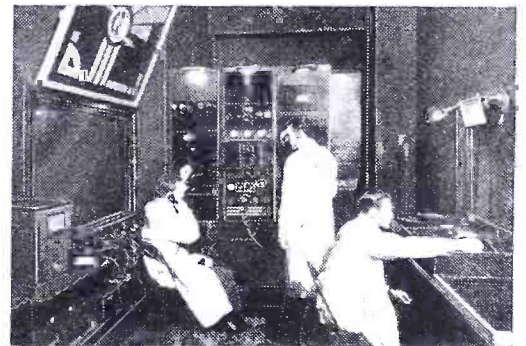

Fig. 9. Sound and image control room—W9XAL—W9XBY.

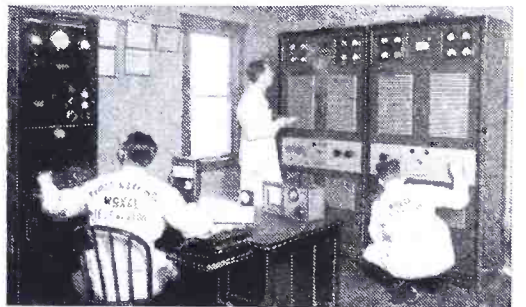

Fig. 10, above. High-fidelity W9XBY (W9XAL's sound).

Fig. 11, below. Mississippi Valley radio fans see and hear W9XAL and W9XBY, respectively, simultaneously.

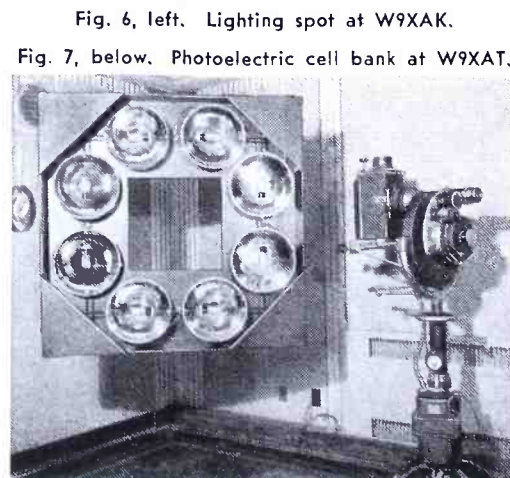
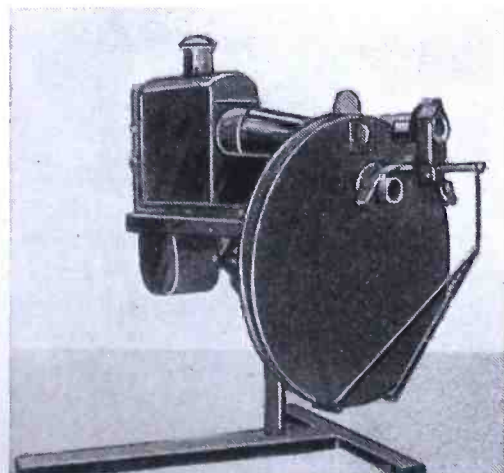
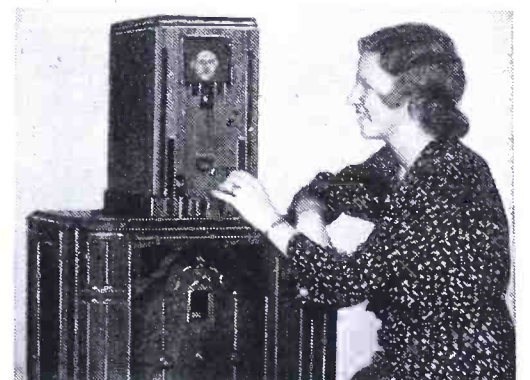

Fig. 6, left. Lighting spot at W9XAK.

Fig. 7, below. Photoelectric cell bank at W9XAT.



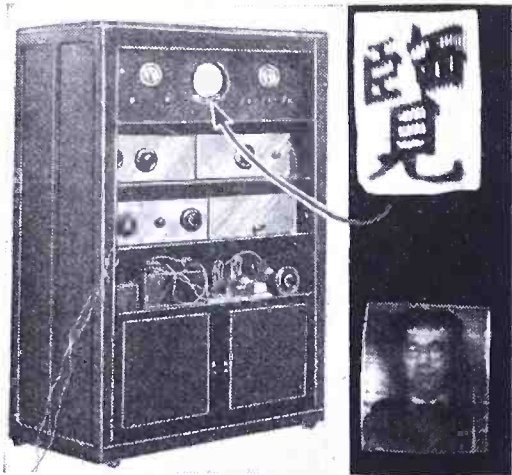

Fig. 12. Japan goes in for television. Experimental receiver of Prof. Takayanagi utilizes a Braun tube. Two images are illustrated.

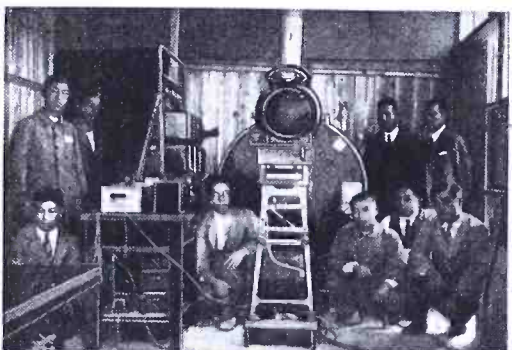

Fig. 13. Professor and staff in laboratory.

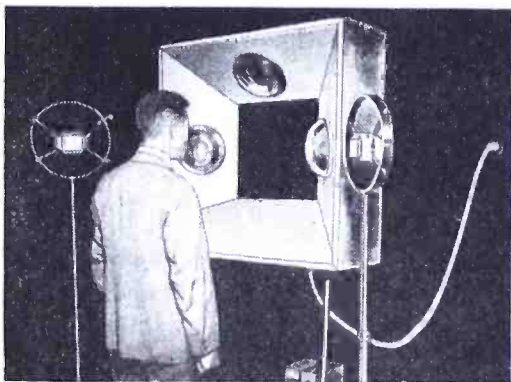

Fig. 14. Nipponese television "subject."

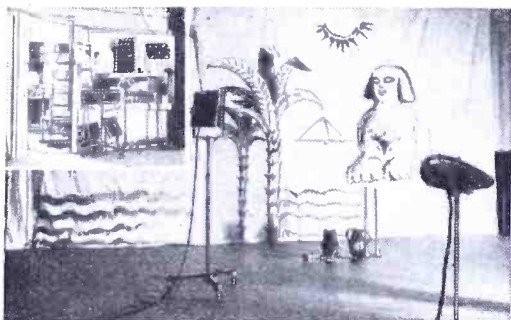

Fig. 15, above. B.B.C. television studio; (insert)—view toward control room.

Fig. 16, below. B.B.C. television control room.

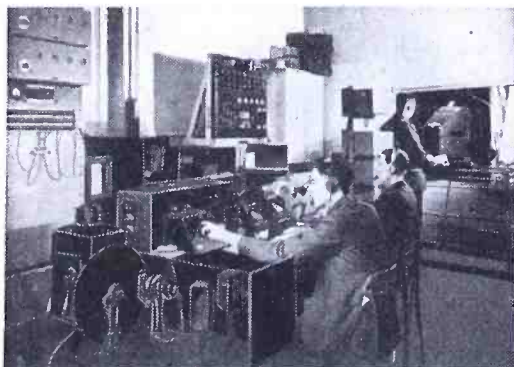
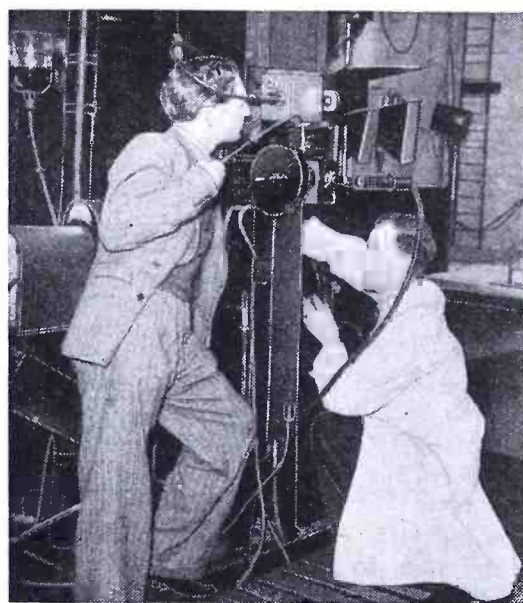

Fig. 18, above. J. L. Baird and his television receiver at the B.B.C. studio.

Fig. 19, right. Baird's "cine-television" camera. This "intermediate-film" apparatus clips the total time for all operations to 30 seconds!



Reichs-Rundfunk-Gesellschaft (German Broadcasting Co.) are now available; an exterior view is Fig. 24, and an interior view, Fig. 25. The Fernseh equipment utilizes a cathode-ray receiver, with 180-line definition—25 pictures per second. A home receiver of Fernseh make having similar image characteristics is illustrated in Fig. 28.

German Broadcasting Co. The German Broadcasting Company has just opened an experimental high-definition television service to the general public on ultra-short waves using 180-line scanning and 25 frames per second. Vision is broadcast on approximately 6.7 meters, and sound on approximately 7 meters. Figure 26 shows the check receiver in the television department of the Berlin Broadcasting House. Figure 27 illustrates the film-scanning apparatus with cathode-ray check tube.

Figure 29 shows the top of the Berlin radio tower (453 ft. high), with the two ultra-short-wave circular aerials, one for the radiation of the television image, and the other for the sound impulses.

In Fig. 30 is reproduced an actual, unretouched television image as seen by the Berlin owner of a home-type television receiver. The image is shown as it appears on the screen of a Manfred von Ardenne television receiver.

(In the heading of this article, on page 76, appears a home interior scene in which the television receiver of Loewe A.G. of Berlin plays an important part.)

Fig. 17. An eager television performer.

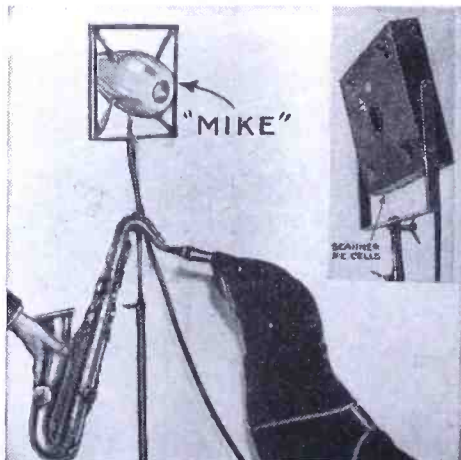

ITALY

Italy has an experimental television station in operation at Milan which has two transmitters, one on 5.05 meters and one on 8 meters. Transmission is on a 180-line basis, 25 pictures per second. The receiver is of cathode-ray type. The Morelli Corp. being the foremost company in the business.

SPAIN

Reports from Madrid indicate that the German radio company, "Telefunken," in collaboration with the Western Electric Co. is to conduct television experiments in a short time from the radio tower of the broadcast station, "Radio Madrid." In well-informed circles, however, there is the belief that these experiments are not to start before the spring of 1936. The plan is to transmit a 180-line image, 25 pictures per second.

HOLLAND

To obtain a suitable basis for experiments with television receivers now being made in the laboratories of the Philips Corp., Eindhoven, Holland, a 5 kw. ultra-short-wave transmitter working on a wavelength of 7 meters will be put into operation within the next few months. This will be the second television transmitter in Holland, as there has been in operation for several months a small, 3-meter television transmitter used for experimental purposes. In future, the sound impulses will be transmitted on a wavelength of about 3 meters, while the accompanying image will be radiated on 7 meters.

RUSSIA (U.S.S.R.)

In the Physical States Institute of Niji-Novgorod, some very interesting television experiments have been made under the supervision of Prof. Schorin during the last few months. High-definition television experiments will be made as soon as the new ultra-short-wave transmitter in Moskow, now in assembly, is completed.

SOUTH AFRICA

Cape Town is once more to the fore. According to newspaper reports, a company has recently been formed and has

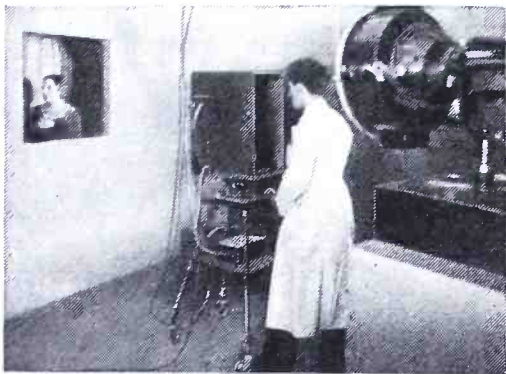

Fig. 20, above. Experimental Parisian television.

Fig. 21, below. Studio scanning set-up in Paris.

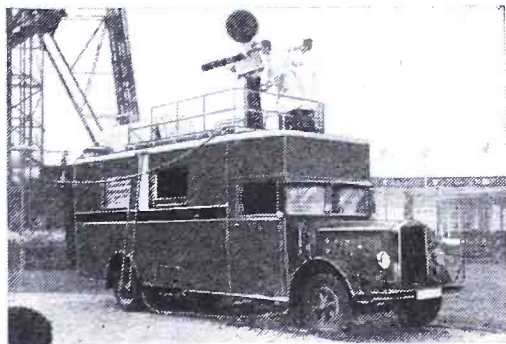
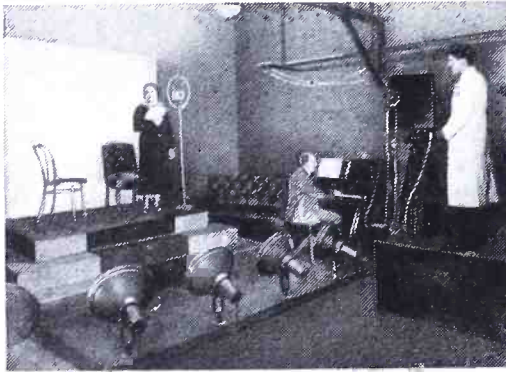

Fig. 24. Fernseh A.G. television car.

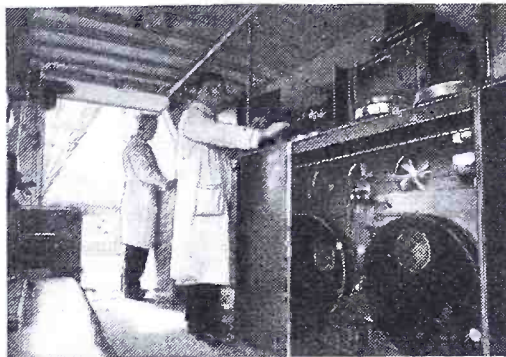

Fig. 25, above. Interior of television truck.

Fig. 26, below. Check receiver, television department, Berlin Broadcasting House.

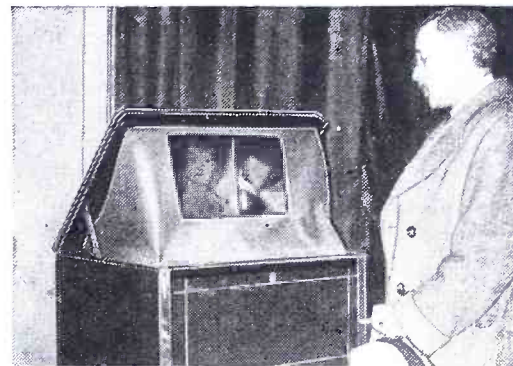
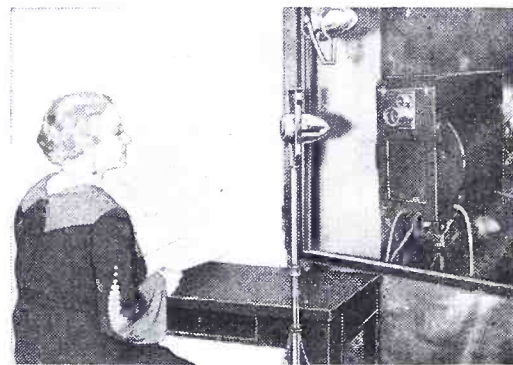

Fig. 22, above. French notables observing reception apparatus in Paris last May.

Fig. 23, below. A fair subject inaugurating French television and accompanying sound.



bought a number of important television patents, and intends not only to erect a television transmitter in Cape Town, in the near future, but also intends to manufacture the required picture receivers.

CZECHOSLOVAKIA

According to a recent statement by a high official of the Czechoslovakian Broadcasting Co., the company expects to erect the first television transmitter in the capitol—Prague. During initial experiments, films made up of excerpts from current "movies" will be used; later, it is expected that direct pick-up programs will be broadcast.

THE RADIO TAX IN EUROPE

England, France, Germany and Italy, each has a broadcast system which is supported by fees that are collected monthly from all the radio listeners. For this reason these television systems can operate with a very limited audience, because it is not necessary to depend upon private sponsors to pay for the cost of the television programs.

However, television in these countries is only for the monied classes (sets are no cheaper abroad than here in America—or, \$300 to \$600 per complete receiver); at the same time, those who cannot afford to purchase a television receiver still must pay the tax, thus they are compelled to



bear the burden of maintaining the television system that serves only the wealthy!

This condition in Europe would be alleviated to a considerable extent if an efficient television receiver could be made available to the consumer at a reasonable price—say, \$100. Even here in America this low list price would result in tremendous buying interest, as reference to Fig. 31 will indicate. Here we find that a 66% per cent reduction in the list price of the television set will bring the instrument within the price range of 1,400 per cent more people.

To speak of the market conditions for the sale of television receivers is to walk right into the question of whether satisfactory image reception is a technical

practicability.

That the answer by the laboratory is "Yes!" is now a positive fact. The continuous and satisfactory operation of the German television broadcast station over a period of months; the report of the British Television Commission, which made a personal country-to-country tour in order to check-up, first hand, on all the phases of television as they now present themselves; the very effective demonstrations that have been given before engineering bodies, etc.; all these serve but to confirm the technicians' statement.

(Continued on page 80)

Fig. 27. Film scanner.

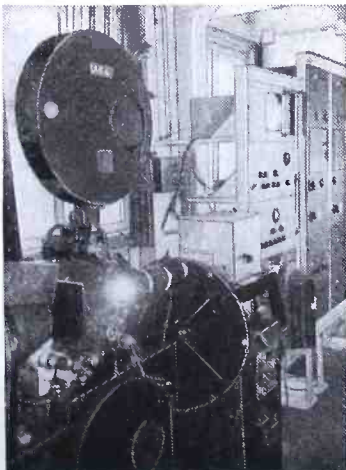

Fig. 28. Fernseh apparatus.



Fig. 29. Micro-wave antenna.



Fig. 30. Unretouched image.



TELEVISION STATIONS

("Experimental Visual Broadcasting Stations")

IN THE UNITED STATES

—Corrected by the Federal Communications Commission, March 1, 1935—

Call Letters	Power (watts)	Company	Location
2,000-2,100 kilocycles			
W2XDR	500	Radio Pictures, Inc.	Long Island City, N.Y.
W8XAN	100	Sparks-Withington Co.	Jackson, Mich.
W9XK	50	University of Iowa	Iowa City, Iowa
W9XAK	125	Kansas St. Col. Agr. & Apl. Sc.	Manhattan, Kansas
W6XAH	1,000	Pioneer Mercantile Co.	Bakersfield, Calif.
2,750-2,850 kilocycles			
W3XAK	5,000	National Broadcasting Co.	Portable
W9XAP	2,500	National Broadcasting Co.	Chicago, Ill.
W2XBS	5,000	National Broadcasting Co.	Bellmore, N.Y.
W9XAL	500	First Nat'l Television Corp.	Kansas City, Mo.
W9XG	1,500	Purdue University	W. Lafayette, Ind.
W2XAB	500	Atlantic Broadcasting Corp.	New York, N.Y.
42,000-56,000, 60,000-86,000 kilocycles			
W2XAX	50	Atlantic Broadcasting Corp.	New York, N.Y.
W6XAO	150	Don Lee Broadcasting System	Los Angeles, Calif.
W9XAL	150	First National Telev. Corp.	Kansas City, Mo.
W1XG	500	General Television Corp.	Boston, Mass.
W9XD	500	The Journal Company	Milwaukee, Wis.
W2XBT	750	National Broadcasting Co.	Portable
W2XF	5,000	National Broadcasting Co.	New York, N.Y.
W3XE	1,500	Phila. Storage Battery Co.	Philadelphia, Pa.
W3XAD	2,000	*RCA Victor Company, Inc.	Camden, N.J.
W10XX	50	*RCA Victor Company, Inc.	Port.-Mobile (Vic. of Camden)
W2XDR	1,000	Radio Pictures	Long Island City, N.Y.
W8XAN	100	Sparks-Withington Co.	Jackson, Mich.
W9XK	100	University of Iowa	Iowa City, Iowa
W9XAT	500	Dr. George W. Young	Portable

*Licenses of RCA Victor Co. assigned to RCA Manufacturing Co., Inc., 3-26-'35; station W3XAD granted additional transmitter to operate on 30,000 watts.

APPLICATIONS ON FILE FOR VISUAL BROADCASTING STATION

(Application for Construction Permit for National Television Corp., 52 Vanderbilt Ave., New York, N.Y.—2,000-2,100 kc., 500 watts.)

(Continued on page 123)

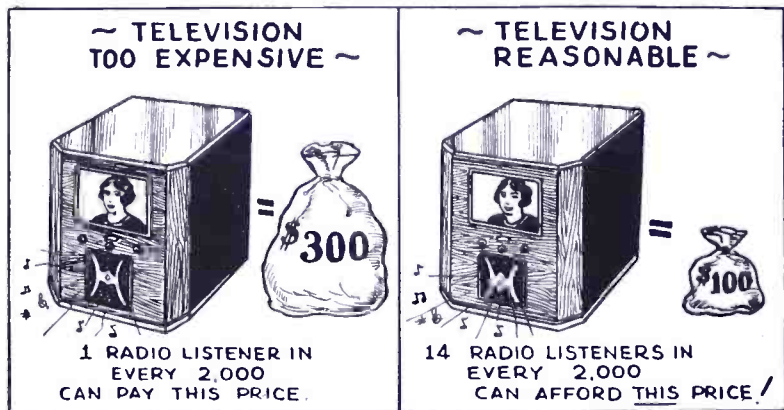
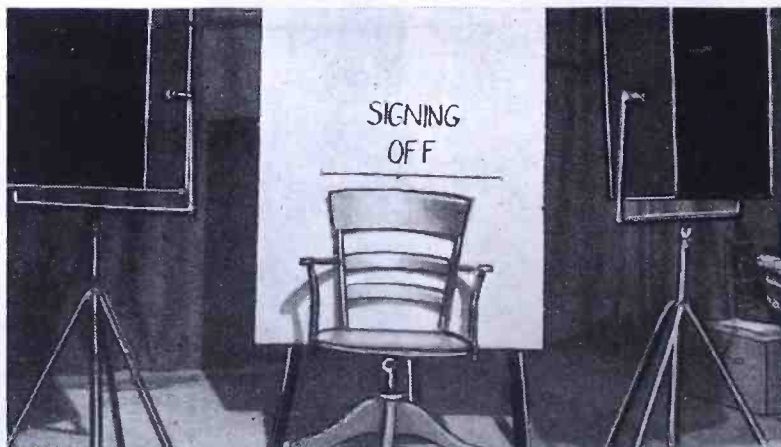
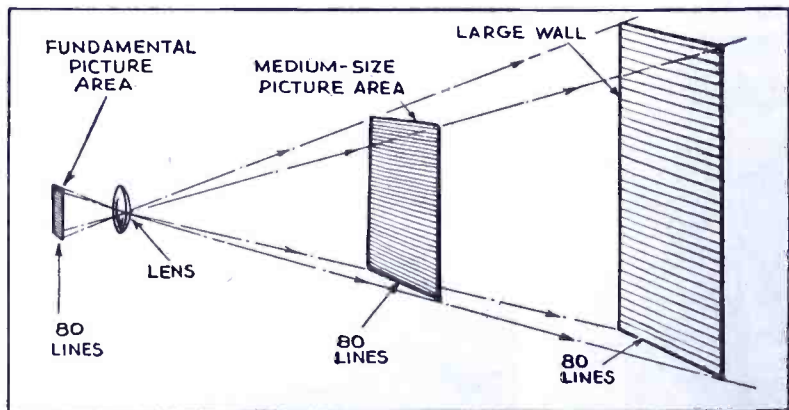
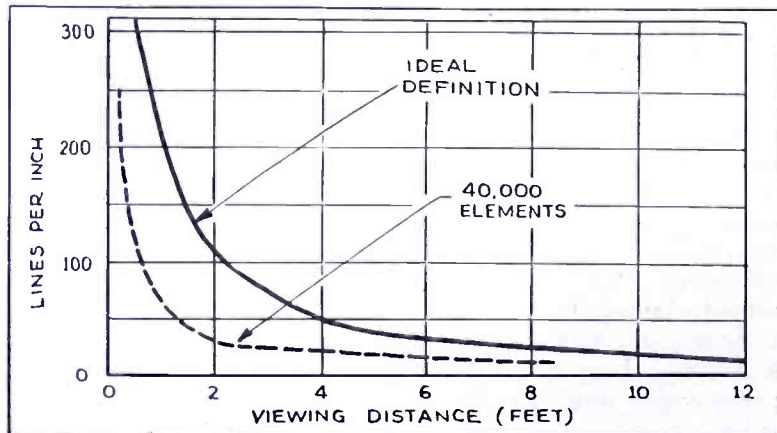

Fig. 31, above. A two-third's reduction enhances salability 1,400 per cent!
 Fig. 32, below. Television definition in "lines" includes entire image area.
 Fig. 33, upper right. Relation between apparent detail and distance.
 Fig. 36, lower right. "Television language" for "good-bye," via W9XAK.



CATHODE-RAY APPLICATIONS IN TELEVISION

Color television, screen blackening, outline aberration, these and other problems in cathode-ray tubes have been overcome.

ALLEN B. DU MONT

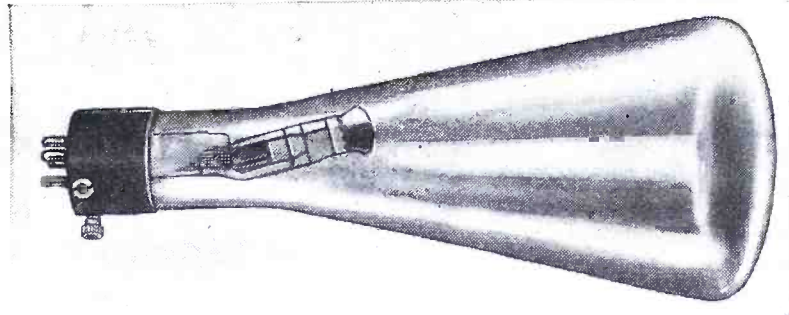

Fig. A. The off-center electrodes correct distortion.

WE ARE on the threshold of successful television due to the enormous strides that have been made in the development of the cathode-ray tube. This tube was originally developed to study A.C. wave forms and voltages, but it was found to be adaptable for television work and would eliminate the mechanical forms of scanning and the troubles of synchronizing.

Fundamentally the cathode-ray tube consists of a filament which is coated with electron-emitting material and a plate close to it on which is impressed a high voltage. The plate contains a small hole so that when the electrons impinge upon it some will be forced through the hole thereby forming a jet or stream which continues to the end of the tube. The flat end of the tube is coated with a fluorescent material which will glow at the point where the electron stream strikes. Two sets of deflector plates set in the path of the stream are used to shift the beam up or down or to carry it from the left to the right depending on which set of plates is in use.

The cathode-ray tube satisfactory for television reception is a special development all of its own as people who have tried to adapt, for television, tubes which were intended for oscilloscope work have soon found. There are two common types of oscilloscope tubes in this country. One type has no focusing electrode but obtains a focus by changing the temperature of the filament. Obviously the temperature of the filament could not be changed rapidly enough to vary the intensity of the spot for television work. Furthermore the size of the spot changes with temperature which would blur the image if it could be seen at all.

The other oscilloscope tube has a separate focusing electrode and the minimum spot is obtained by adjusting the

negative bias to the electrode. However, as the spot must remain the same size as the intensity of the stream is varied, this type is also unsatisfactory. The curve of accelerating electrode current vs. focusing electrode voltage clearly shows how the size of the spot will vary, as illustrated in Fig. 1.

In general there are two possibilities in cathode-ray tubes for television reception. The first is to design a small tube of extremely high intensity giving, say, an image about the size of a motion picture frame and then projecting it to the desired size as in a motion picture projector. This method is now in the stages of development. However, it is necessary to get an extremely small spot to operate the tube at 120 lines per frame or higher.

The second possibility and the one more commonly being used is to make the screen of the tube the size desired for the image. This method is most satisfactory at the present time and is being used extensively in England and Germany. The maximum size at present is limited because the bulb must be made of "hard" glass as there is almost a ton of pressure on the flat screen! This glass necessitates the use of oxygen fires, and because of the large volume a considerable period of time is consumed in exhausting them. However tubes having up to 5 in. screens can be made with soft glass without danger of breakage and at considerably less expense.

The required characteristics of a cathode-ray tube for television work are enumerated below.

(1) The tube should operate with A.C. on the filament and rectified A.C. on the other electrodes.

(2) The grid or modulating electrode should operate at a negative bias and draw no grid current in normal operation.

(3) The tube should be designed so that complete modulation can be obtained from the output of the detector, eliminating the use of A.F. amplification.

(4) In modulating the intensity of the spot the velocity of the beam should not change.

(5) During modulation the size of the spot should remain constant.

(6) It should be possible to adjust the spot for any number of lines per frame.

(7) The particle-size of the material on the screen should be small enough so that no grain shows in the picture.

(8) The decay curve of the fluorescent salt should be of the persistent type, the time of decay being slightly less than the time required for the spot to return to any given position.

In Fig. 2 is shown a characteristic curve of a tube which meets these requirements. The variation of the size of the spot with accelerating voltage is clearly shown in Fig. 3.

Unusual brilliancy can be obtained with a cathode-ray tube which contains a small amount of inert gas. This tube is illustrated in the heading. Note that the elements are mounted "asymmetrically." This is done to overcome distortion of the electron stream that exists in other gas-filled tubes. The gas-filled cathode-ray tube is practically universally used throughout Germany. That is the reason why German television pictures are brighter than the English.

FIXED SPOT DOESN'T DARKEN!

The material which is used for the fluorescent coating of the screen has also been highly developed. A combination of salts has been found by the Allen B. Du Mont Labs. that will not "burn" (discolor) when the stream is allowed to remain for some time on a

(Continued on page 105)

Fig. B. Details A and C show the ordinary type of tube, while details B and D show how a symmetrical placement corrects distortion.

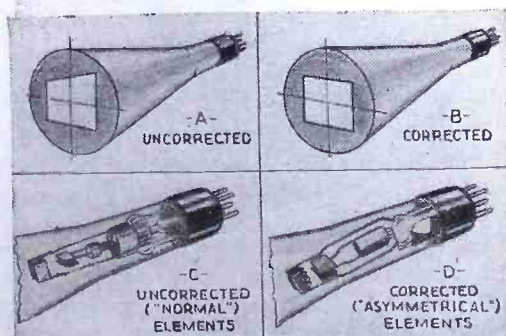
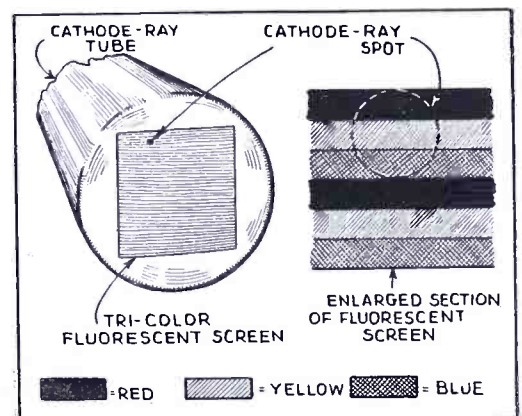
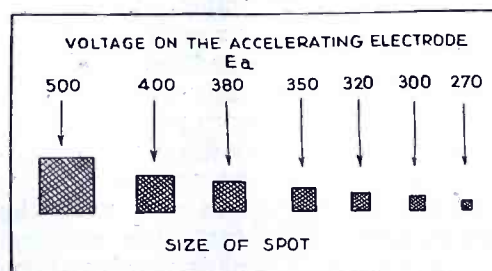
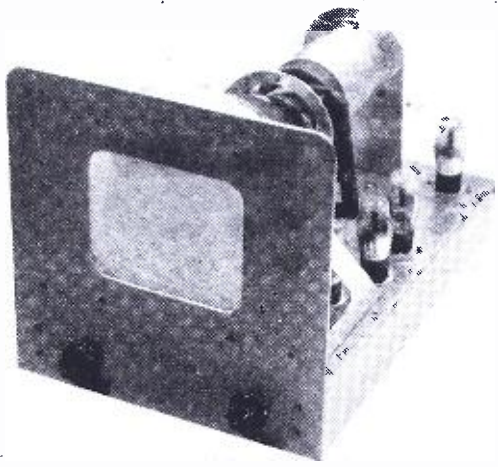

Fig. 3, below. The size of the spot is controlled by the voltage on the accelerating plate, as shown.

Fig. 4, right. Alternate layers of red, blue and yellow in very narrow strips permit "color" television reception.





SOME FACTS ABOUT THE FARNSWORTH SYSTEM

One outstanding television system is that developed by Farnsworth, who recently combined with the Fernseh A.G. interests in Germany. A Farnsworth station is now being erected at Philadelphia—for experimental purposes.

A. H. BROLLY AND R. C. HERGENROTHER

MUCH has been written of the commercialization of high-fidelity television in Europe where advances are stimulated by governmental favor. At the same time, it is acknowledged that the United States is foremost in technical advancement of this art. With the present ready interchange of knowledge between countries it is not reasonable to expect such an unbalance to continue. Even now we have promise of early commercialization tests in the United States and a goodly representation of American technique in the European development.

Outstanding in American television development is the Farnsworth system, one of the first in the world to employ electron scanning at transmitter and receiver. The "image dissector" pickup camera was displayed to the public at the Franklin Institute in Philadelphia last summer. ("Television by Electron Image Scanning" by Philo T. Farnsworth, *Journal Franklin Institute*, October, 1934.) Now its counterpart, a high-fidelity reproducer of practical design, is being constructed as a model for German television engineers. The Fernseh A.G. of Germany has adopted many of the outstanding features of this reproducer to be incorporated in its receiver for exhibition at the Radio and Television Exhibition in Berlin, in August, and later

to be put on the market for the television public of Germany.

HIGH FIDELITY RECEIVER

This reproducer, incorporating all the essentials of a television receiver except the radio-frequency and detector circuits, is shown in the photographs. It contains magnetic circuits for focusing and scanning with the cathode-ray tube, oscillators to deflect the ray in scanning, and the high-voltage supply for the anode of the tube.

Magnetic fields are employed entirely for focusing and deflecting. These offer two outstanding advantages: simplicity and cheapness of construction of the cathode-ray tube, and a sharpness of focus throughout the picture field which is difficult to obtain by any other means.

A single amplifier stage for the picture signal is included on the chassis. This may be compared to the output stage of a sound receiver except for its wide-band amplification. Another tube amplifies and detects the line and picture-frequency synchronizing impulses which are transmitted with the signal. This permits separating the impulses from the signal on the basis of their amplitude and polarity. They are then applied to the respective oscillators to effect automatic synchronizing.

The scanning circuits are designed for a 240 line picture field, a value which has been shown to give very pleasing picture detail. ("A Modern Picture of Television," by Wilhelm E. Schrage, *Radio-Craft*, April, 1935.) This line structure with a picture repetition rate of twenty-five per second is widely used in current developments of high-fidelity television in Europe. For this combination, the line scanning frequency is 6,000 cycles. A vacuum tube oscillator supplies current of this frequency and of a saw-tooth wave-shape for transverse or line scanning. This produces a uniform scanning rate with consequent even illumination and equally sharp detail across the whole width of the picture field. The return of the scanning spot requires but one-tenth as long a time as the scanning of one line; approximately 1/60,000-second. During this short period, an impulse is received over the picture channel to synchronize the oscillator, automatically holding it in step with the transmitter. The oscillator employs one tube of an ordinary receiver type

and a small transformer of special design. ("Television by Electronic Methods," by A. H. Brolly, *Electrical Engineering*, August, 1934.)

DOUBLE SCANNING

Vertical or frame-frequency scanning is accomplished with saw-tooth currents which are generated by an oscillator similar to that used for line scanning. This scanning runs at 50 cycles per second so that the picture field is scanned twice during each picture. Between successive scanings the whole picture field is displaced vertically by an amount just sufficient to cause the lines of one scanning to fall between those of the preceding one. This process is known as interlacing; it has the effect of reducing flicker and line structure of the reproduction.

The anode of the cathode-ray tube is supplied with 4,000 V. by a small unit employing a rectifier tube no larger than a radio receiver tube. The
(Continued on page 103)

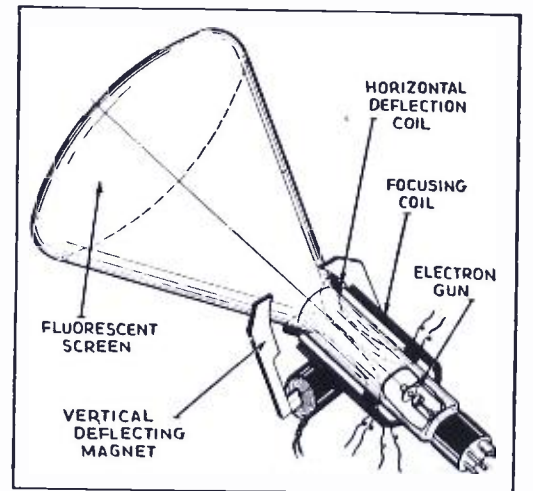
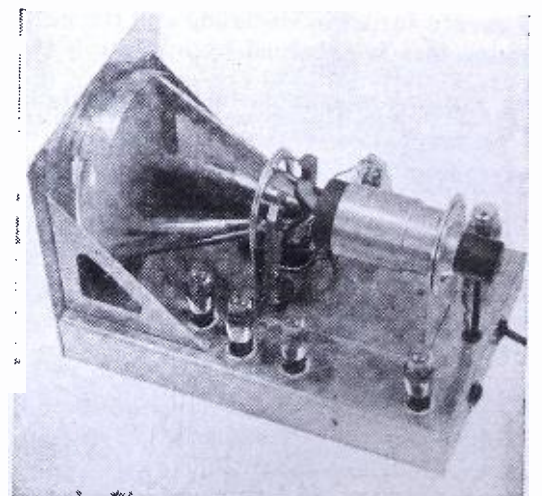

Fig. 1, above. The interior of the "oscillight." Below, interior of television scanning chassis.



NOTICE TO SET BUILDERS

In the forthcoming, SPECIAL SET BUILDERS NUMBER of RADIO-CRAFT will appear a wide variety of radio receiver designs for the constructor. Large-set construction information to tickle the palate of the advanced radio man will be given; small-set descriptions will be available for the inexpert beginner. Even the new metal-base tubes are included in some of the instrument designs. Experimenters will find a wealth of interesting ideas and technical developments in the new circuits, no matter whether their interest lies in circuits having 1 tube or 10!

RADIO-CRAFT'S "IDEAL RADIO SERVICE SHOP" CONTEST

"There's still time to send in your letters, fellows! Views of the prizes, and added data about the contest appeared in last month's issue."

Signed JACK GRAND, DIRECTOR

WOULD you like to win a new oscilloscope for your shop—or a new analyzer—or a new service oscillator—absolutely without cost to yourself?

Here is the way that you can do it. Every Service Man has some original ideas about how he would like to have his shop or laboratory arranged; what equipment he would like to have in it; what system he would like to use in keeping records, etc.

In other words, get your thinking cap on and figure out how you would like to have your shop if money and

time were no object.

Then sit down and explain your ideas in a letter of 300 words or less, after reading the simple instructions below. Do it now—you can't lose anything and you may be one of the winners of the prizes described on this page. Remember, the letter must be postmarked not later than midnight, Aug. 15, 1935. (See the rules of the contest, at end of article.)

THE REASON FOR THE CONTEST

In case you are wondering how we can offer such valuable and useful prizes for this contest as are listed

here, and shown pictorially in the preceding issue—here is the reason behind it.

As you probably know, the prominent manufacturers of service equipment are always on the look-out for new ideas which can be used to improve the equipment they make to assist the Service Man in his work. These companies have cooperated with us in supplying the prizes.

You will give them valuable information in return for these prizes—information which will enable them to

(Continued on page 105)

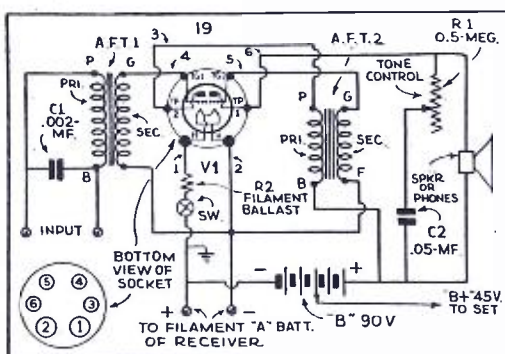

A BEGINNER'S "2-IN-1" A.F. AMPLIFIER

A companion amplifier to the beginner's 1-tube set which appeared last month. The 2 stages use only 1 tube.

J. S. CAULFIELD

A COMPANION amplifier for the receiver described last month, "How to Make a Novel 1-Tube Battery Set," is the one-tube amplifier which is illustrated in the photos, and shown in the diagram.

Although the amplifier is composed of one tube, it actually develops the gain (amplification) of two single tubes. This effect is accomplished by using the 19-type tube, which combines in one bulb two "high-mu" triodes. This tube designed for use in the output stage of battery-operated receivers.

A conventional 2-stage audio amplifier circuit is used with the addition of a tone control. High-gain A.F. transformers are used throughout.

As noted in the diagram, the filament circuit of the 19-tube includes a limiting resistor to absorb the over-voltage supplied by the "A" cells. (Note: Use only 3 V. "A"—not the 4½ v. value indicated on the set diagram.) The amplifier has its independent "A" switch, which is ganged to the tone-control potentiometer.

Although the amplifier shown used the conventional socket screwed to the baseboard, we have since found that some type 19 tubes have a tendency to be microphonic. Therefore, it is advisable to insert sponge rubber under the socket before mounting.

If fixed condensers are used across the headphone or "out-

put" terminals of the receiver, these should be removed since the .002-mf. condenser connected across the first A.F. transformer or "input" is sufficient, the two "output" posts of the set being connected to the two "input" posts of the amplifier.

The completed amplifier will give ample gain to operate a loudspeaker with sufficient volume.

LIST OF PARTS

Two General Trans. Co. high-ratio A.F. transformers, A.F.T. 1, A.F.T. 2

(Continued on page 108)

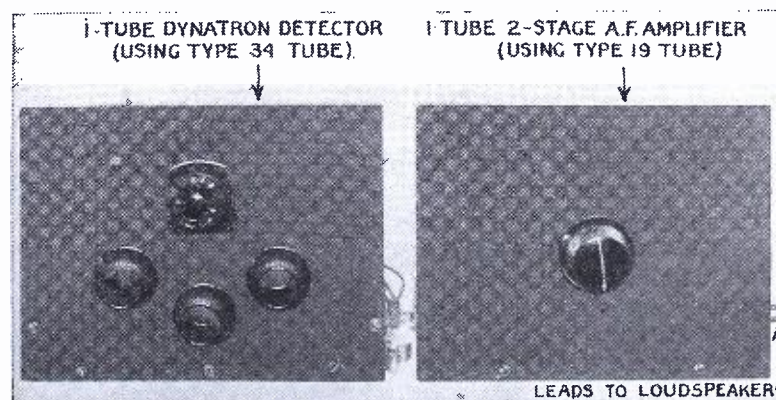

\$400.00 IN PRIZES

1st PRIZE RCA No. 9545 Portable Cathode-Ray Oscillograph. Value, \$84.50.	Portable model). Value, \$39.95.
2nd PRIZE Weston Model 663 Volt-Ohmmeter and carrying case. Value, \$48.75.	5th PRIZE Clough-Brengle Model UC Portable Vacuum Tube Voltmeter. Value, \$34.80.
3rd PRIZE Hikok Model OS 7 All-Wave Service Oscillator. Value, \$48.00.	6th PRIZE Triplett No. 1200 Multimeter and No. 1220 Free-Reference-Point tester. Value, \$34.67.
4th PRIZE Supreme Model 333 DeLuxe Set Analyzer; or, optionally, Supreme Model 85 Tube Checker (in either Counter or	SPECIAL PRIZE Six Gernsback Consolidated Official Radio Service Manuals. (Except for the manuals, above are net values; in several instances list prices are considerably higher.) Value, \$17.50 (each.)

THE LATEST RADIO EQUIPMENT

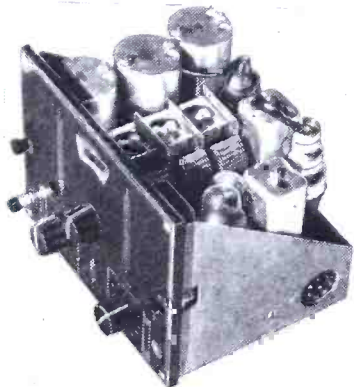

A 3-tube 'plane set. (747)



Crystal hand "mike." (748)



A 6 V. and 110 V. portable. (749)

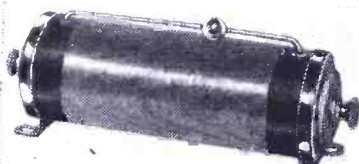

A 4-use set attachment. (750)

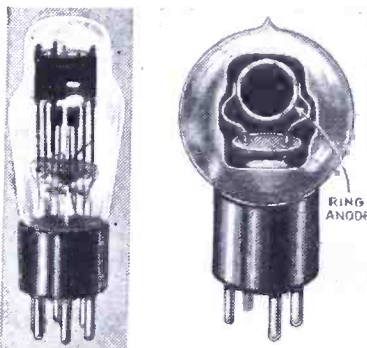

Left, 1B5/25S battery tube. (751)
Right, television neon lamp. (752)

Below, P. A. reinforcement unit. (753)

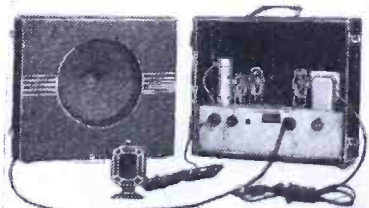

AIRPLANE SET (747)

NEWEST in airplane sets is a 3-tube super. which measures only 7 $\frac{1}{4}$ ins. each way; weight, only 11 lbs. Ranges: 200-400 kc. and 550-1,500 kc. A headphone set for the private plane. Featured in the design is a "static reducer" which serves to reduce the amplitude of crashing static. Filaments operate on 6 V.; uses separate "B."

CRYSTAL HAND "MIKE" (748)

THE INHERENT advantages of the piezoelectric microphone have been adapted to a hand unit. Impedance is about 0.4-meg. at 1,000 cycles. Has no inherent noise; is immune to atmospheric moisture, barometric and temperature changes. (Three or four of these "mikes" may be mixed without using transformers.) Wide frequency range; operates 200 ft. from preamplifier.

6 V. OR 110 V. PORTABLE SET (749)

AUTOMATIC switching of the circuit by means of the power plug terminal at the set permits this receiver to be operated on either 110 V. A.C. or 6 V. D.C. A 5-tube superhet. circuit incorporating A.V.C. is utilized. Requires no "B" or "C" batteries.

USEFUL SET ATTACHMENT (750)

(Insuline Corp. of America.)

THE MERITS of the adjustably-resonant circuit may be applied to any radio set by using the slider-tuned inductance, illustrated. Manufacturer recommends it for use as: (1) aerial eliminator; (2) antenna tuner; (3) a wave trap to eliminate interfering stations; and, (4) short-wave converter wave trap.

1B5/25S BATTERY TUBE (751)

(Hygrade Sylvania Corp.)

GENERALLY known in the trade as the "25S," this tube has been greatly improved in its characteristics as a multipurpose duodiode-triode, and has been given the 1B5 prefix; this identifies the tube as being a 5 (useful)-element type, with 2 V. filament (drain is 60 ma.) Characteristics: Plate, 135 V., max.; 0.8-ma.; 35,000 ohms.; control-grid, -3 V.; mutual conductance, 575 mmhos.; amplification factor, 20.

IMPROVED TELEVISION LAMP (752)

SMALL-IMAGE reproduction is improved by using the newest in neon lamps. Use of a ring anode

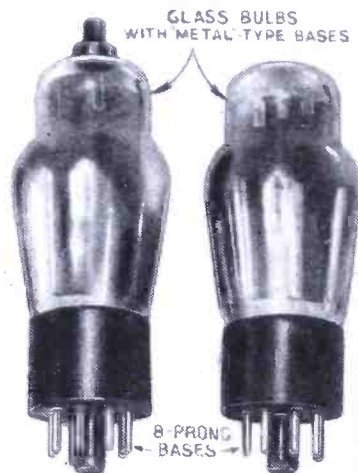

An 8-prong "glass-metal" tube. (754)

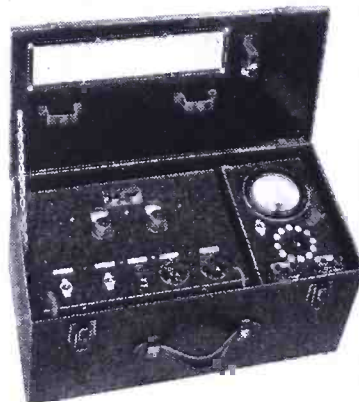

A "combination servicer." (755)



Japanese-steel pickup. (756)

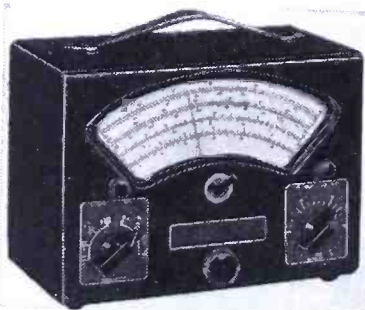

Improved service oscillator. (757)

New iron-core I.F. transformer. (758)

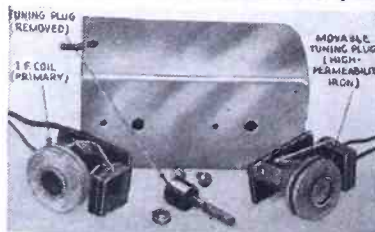

results in an equi-current field; the spherical, alkali-coated cathode (which has a 1 in. window) permits use of the reflected light without introducing distortion. Up to 60 ma. may be used; impedance is only about 600 ohms.

SMALL SOUND-REENFORCEMENT SYSTEM (753)

(RCA Mfg. Co.)

A SMALL (6 W.) P.A. and sound-reinforcement unit has been developed along portable lines; incorporates microphone, amplifier and reproducer. Operates on 110 V., A.C.

Although designed as a low-cost system, it features exceptional tone quality and simplicity of operation.

JUST ANNOUNCED—A NEW 8-PRONG "GLASS-METAL" TUBE (754)

DESIGN engineers and Service Men now are all agog about the latest in electronic devices—a line of tubes having 8-prong bases, and with identical characteristics to the new 8-prong metal-envelope tubes, but having a glass envelope. Two of these new "glass-metal" tubes are illustrated; they are the 6K7 and 6C5, electrical and mechanical counterparts of which (as to characteristics and bases), except for the envelope, are found in the "metal" series, under the same designations.

Design engineers are using these glass-metal tubes until such time as it is convenient to substitute metal tubes as direct replacements. Service Men probably will use the glass-metal tubes for some time to come as service replacements of metal tubes (which new sets are being designed to use), until such time as the production of metal tubes reaches the point where they offer greater competition to the new, relatively low-price glass-metal tubes.

A "COMBINATION SERVICER" (755)

(Clough-Brengle Company)

THIS "combination servicer" includes a multi-range volt-ohm-milliammeter for measuring A.C. and D.C. voltage or current values, resistance and capacity, and receiver output; and an all-wave A.C.-D.C. line-operated service oscillator.

A dynamic microphone. (759)

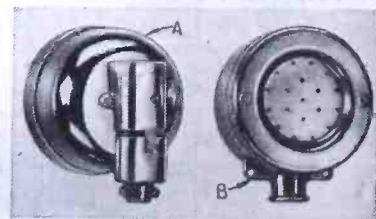

Name and address of any manufacturer will be sent on receipt of a self-addressed, stamped envelope. Kindly give (number) in above description of device.

JAPANESE-STEEL PHONO. PICKUP (756)

NEWEST in high-impedance magnetic pickups is a unit that uses a new aluminum-nickel-steel invented in Japan. The relative coercive force is 300 to 700 gauss (high cobalt steel measures about 200 gauss; and tungsten, chromium and chromium-tungsten, about 60 to 70 gauss). Units available in impedances varying from 10 ohms to 20,000 ohms; several different types of arms and finishes are available.

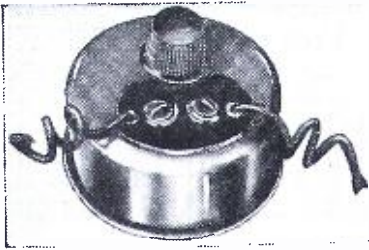

Antenna noise rejector. (761)

FULL-VISION SERVICE OSCILLATOR (757)

THIS service oscillator features the use of a full-vision, direct-reading scale. Range is continuously variable over 8 bands; covers fundamental frequencies from 90 kc. to 25 megacycles. Modulated 85 per cent, 400 cycles. Dial standardized at 48 points against crystal-controlled standards. Battery operated.

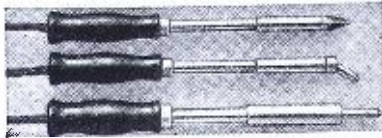

Radio-type soldering irons. (762)

PERMEABILITY-TUNED I.F. TRANSFORMER (758)

(The Electrical Winding Corp.)

KKNOWN as the "Elwin Linoperm," this new I.F. transformer utilizes an adjustable plug of high-permeability iron in lieu of variable condensers, for resonating the primary and secondary circuits; (fixed condensers resonate the circuit within operating range of the plug adjustment). These transformers are the design of B. S. Vilkomerson; their exceptional efficiency results in voltage gains of 10 to 275 per stage when they are used as replacements for air-core units.



Porcelain-case condensers. (763)

NEW DYNAMIC MICROPHONE (759)

THIS moving coil (dynamic) microphone is recommended for the following characteristics: extreme ruggedness, weather-proof, blast-proof, wide-angle pickup over 135 degrees, no background noise, suitable for close-talking, draws no operating current. Models for various frequency ranges are available with response of plus or minus 1 db. from 40 to 7,500 cycles, to 30 to 12,000 cycles. Impedance at 1,000 cycles is 30 ohms. Chromium finish.

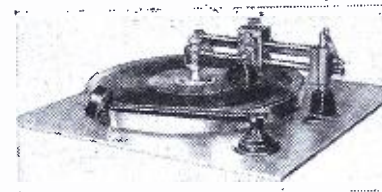

Phono. recording unit. (764)

A "COMPONENT ANALYZER" (760)

(Triumph Mfg. Co.)

THIS device is a condenser bridge analyzer suitable for measuring condensers, coils, resistors, power factor and continuity. Operates from 110 V. A.C. line. Ranges: resistance, 5 ohms to 2 megs.; capacity, 50 mmf. to 20 mf.; inductance, 50 microhenries to 20 henries. Contains standards of capacity and resistance, and a 1 millihenry coil.

A "component analyzer." (760)



"Electric eye" color tester. (765)



Newest in car-radio sets. (766)

Beat-frequency oscillator. (767)



ANTENNA NOISE REJECTOR (761)

TWO binding posts are provided for connection of a twisted-pair downlead; antenna and ground leads connect to their respective posts on the set. The variable resistor in the rejector matches impedances, and is adjusted for minimum noise and maximum signal strength. (Noise picked up by the downlead goes through the windings, to the center point of the resistor, and thus to ground. The signal on the other hand creates a difference-voltage that is applied to the antenna binding post.)

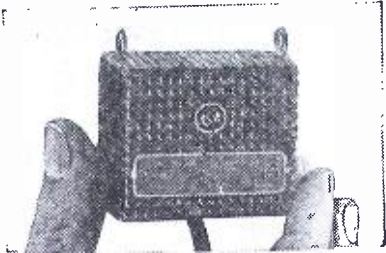

Diminutive velocity "mike." (768)

HIGH-QUALITY SOLDERING IRONS (762)

SOLDERING irons especially suitable for radio repair men's kits, as well as for general shop use are illustrated. These irons consume only 100 W., and are lightweight and durable. Element is on refractory porcelain and is guaranteed against burnouts.

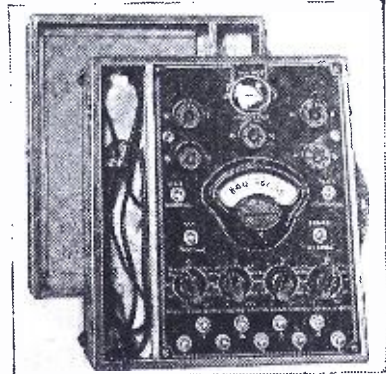

Tester for "metal" tubes. (769)

PORCELAIN-ENCASED CONDENSERS (763)

(Cornell-Dubilier Corp.)

ALTHOUGH designed mainly for use in transmitting circuits, engineers will be interested in a new line of condensers, hermetically sealed in glazed porcelain containers, which may be used in cathode-ray equipment, high-power amplifiers, etc. Capacity range is 50 mmf. to 0.1-mf. in voltage ratings from 2,000 to 12,500 V. (The ceramic cases are not subject to absorption effects in powerful fields.)

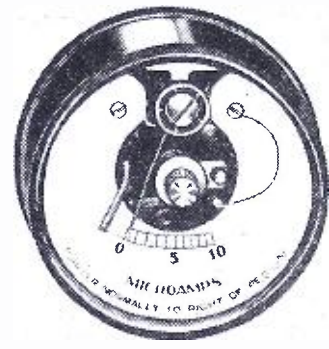

Circuit-closing relay. (770)

BLANK-RECORD RECORDER (764)

A HOME-RECORDING machine ideal for making records of your favorite programs while listening. Merely connect the cutting head to the loudspeaker voice-coil. Operates on 110 V. 60 cycles. Rim drive; 13-in. turntable; 15-ohm cutting head; pickup impedances of 15 to 5,000 ohms; 78 or 33 1/2 r.p.m. motor, optional.

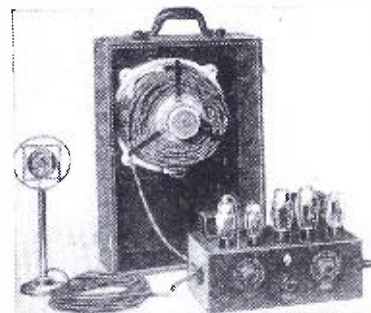

Compact A.F. amplifier. (771)

COLORIMETER (765)

THIS instrument operates by reflected light, its photoelectric cell covering a much wider band than can the human eye—range extends from infra-red to ultra-violet. Used for accurately matching color samples 2 ins. in dia. (Specify whether light-line or storage battery operation is desired.)

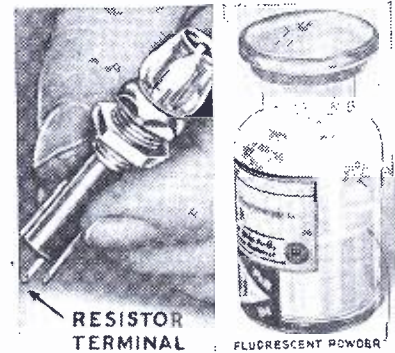

Left, neon pilot light. (772)
Right, fluorescent compound. (773)

NEW CAR-RADIO SET (766)

"SUPPRESSORLESS" operation of this 7-tube car-radio superhet. is featured. Its design utilizes one each of the following tubes: 6A7, 85, 41, 6A6 and 84; and two 6B6s. Large, 8-in. dynamic reproducer. Incorporates delayed A. V.C., and duplex antenna connections for turret-top cars. Instrument-board controls available for foremost cars.

BEAT-FREQUENCY A.F. OSCILLATOR (767)

(The Audio-Tone Oscillator Co.)
TWO phase-shift-controlled oscillators operating at 165 kc. deliver inputs to two balanced rectifiers to

Below, panel-type recorder. (774)

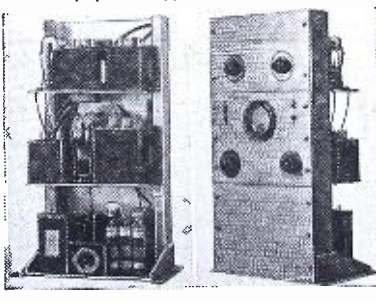

SHORT-CUTS IN RADIO

FIRST PRIZE \$10.00
 SECOND PRIZE 5.00
 THIRD PRIZE 5.00
 Honorable Mention

EXPERIMENTERS: Three cash prizes will be awarded for time- and money-saving ideas. Honorable mention will be given for all other published items. Send in your best "kinks"!

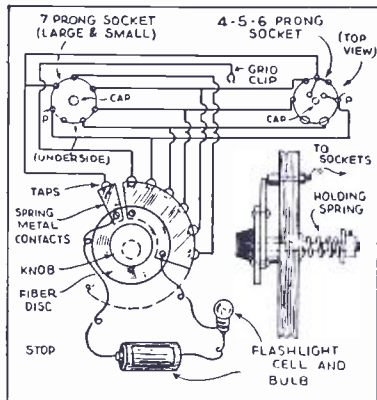

Fig. 1. A quick tube "short" checker.

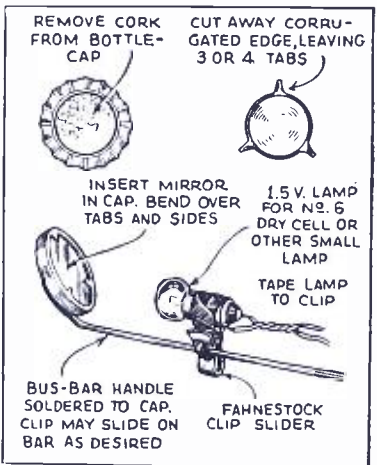

Fig. 2. An electric probe mirror.

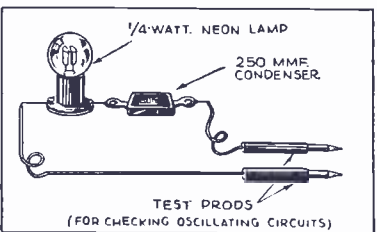

Fig. 3. A simple oscillation tester.

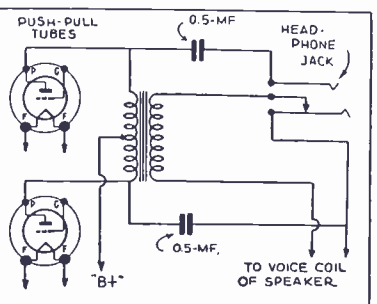

Fig. 4, above. "Phone" connection.

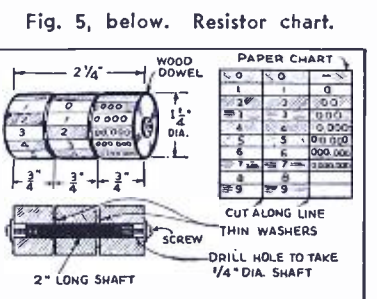

Fig. 5, below. Resistor chart.

FIRST PRIZE—\$10.00

A DEVICE TO TEST "SHORTS" IN TUBES. There are 21 possibilities for an accidental contact between any two of the 7 elements within a pentagrid tube! The "short" test devices on modern analyzers will indicate only a portion of the 21 possible shorts. In the experience of the writer recently, a tube indicated O.K. on the tester and yet the tube did not function properly in the receiver. The trouble was found to be due to an internal short in the tube. A device is illustrated in Fig. 1 whereby a short between any two elements can be easily detected. It can be built from old parts in a short time. The operation is very simple. Merely place a tube in the correct socket and turn the knob to the "stop" point. If no flash is indicated by the bulb, the tube is O.K. A bell-ringing transformer may be used in place of the flashlight cell.

LOUIS B. SKLAR

SECOND PRIZE—\$5.00

ELECTRICALLY ILLUMINATED PROBING MIRROR. Most Service Men know that a small mirror such as dentists use is handy for searching within the dark spots of a radio chassis. The advantage of the mirror (see Fig. 3), which I designed with the aid of "Mother Necessity," is that the handle can be bent to any convenient form, so as to reach into inaccessible parts of the chassis.

WM. B. LAWTON

THIRD PRIZE—\$5.00

SUPERHET. OSCILLATION TESTER. Here is a practical tool for servicing superhets. It indicates if the set oscillator is functioning or not. The hook-up is shown in Fig. 3. In order to test for oscillation place one test prod on the plate of the oscillator tube and the other prod to the chassis. If the oscillator is working the bulb will light.

MRS. OLE FUGLESTAD

HONORABLE MENTION

CONNECTING HEADPHONES TO ANY RECEIVER. With the growing popularity of international broadcasting the need for a headphone connection to a receiver has become important. A simple and effective method of connecting in "phones" is illustrated in Fig. 4. When the phones are plugged in,

Fig. 6. Signal for power speakers.

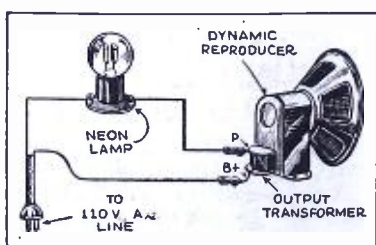

the speaker is cut off. The 0.5-mf. condensers should have a working rating of 500 V.

J. ROSSBACH

HONORABLE MENTION

POCKET-SIZE REVOLVING RESISTOR COLOR-CODE CHART. All resistors under 5 W. rating are marked with a color code in place of the actual value. In order to determine the resistance it is necessary to have a color chart. Figure 5 illustrates how to make a revolving chart that will save much time. Complete construction details are shown. It is only necessary to twirl the various colors into position for the body, tip and dot, and the resistance is instantly indicated.

HAROLD J. CLARK

HONORABLE MENTION

PRODUCING A STRONG SIGNAL FOR LINING UP LOUSPEAKERS. When centering voice coils of dynamic speakers a good strong signal is necessary. It can be obtained as shown in Fig. 6 by connecting a neon lamp in series with a 110 V. line. Alligator clips should be used for quick connection to the output transformer.

R. C. RICKARD

HONORABLE MENTION

A "HURRY-UP" TEST CLIP. Many times when testing or experimenting with circuits it is necessary to make some connections in a hurry. The test clip shown in Fig. 7 will readily solve this problem. It is made from an alligator clip and a binding post as clearly illustrated.

JOHN MODNOSKY

HONORABLE MENTION

INCREASING THE BASS RESPONSE OF MAGNETIC SPEAKERS. A cardboard paper basket, with the bottom removed, and fixed to the back of a speaker cabinet as shown in Fig. 8, greatly increases its baffle area and therefore increases the bass response of the speaker. A substitute for the basket may be constructed from a clothes box by cutting and bending the cardboard into a tube of the right diameter.

CLYDE J. DAY

HONORABLE MENTION

AN EFFICIENT CONTINUITY AND CONDENSER TESTER FROM ODD PARTS. A list of parts for building

Fig. 7. A handy clip for testing.

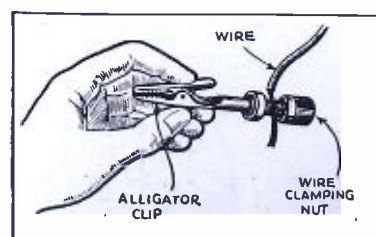

this combination tester is shown on the diagram illustrated in Fig. 9. Any one of the 4 tubes specified may be used for a rectifier. A leaky condenser is indicated by a series of slow flashes in the neon bulb. Should the neon bulb fail to light, the condenser under test is open. Painting the bulb black on one side will aid in detecting very high resistance leaks.

W. B. BABCOCK

HONORABLE MENTION

AN INEXPENSIVE METHOD OF TESTING VIBRATORS USED IN AUTO-RADIO SETS. Figure 10 shows the simplicity of this vibrator tester. By plugging into the set vibrator socket and then inserting the vibrator in the socket on the tester, one may be able to clean and adjust the points—using the set for power. Adapters may be used for different vibrators.

The bases of old tubes will make an ideal plug for the end of the cable which is inserted in the set. Since the tester will be used around the car all the time it is advisable to use a metal case to house the apparatus. A 5 A. battery charging meter can be used.

O. E. PAYNE

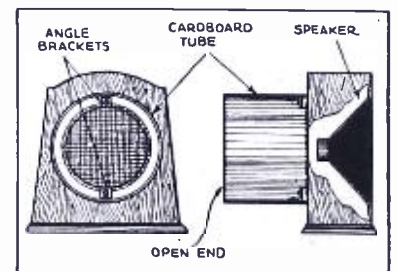

Fig. 8. Increasing speaker response.

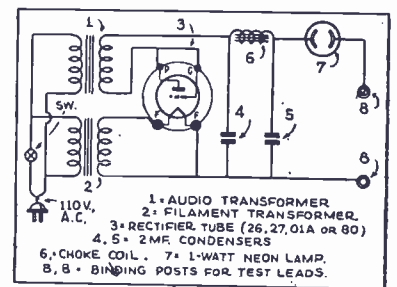
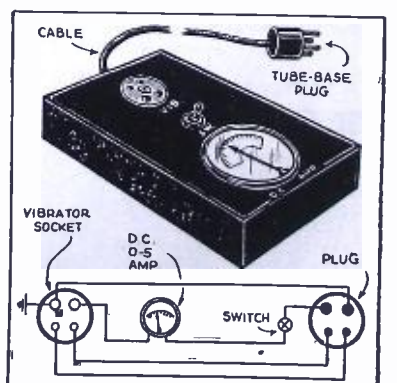

Fig. 9, above. A combination tester.

Fig. 10, below. "B" vibrator tester.



RADIO-CRAFT receives hundreds of magazines from all parts of the world. Since the cost of subscribing to each of these would be prohibitive for most radio men, we have arranged with technical translators to prepare reviews for our readers.

INTERNATIONAL RADIO REVIEW

180-LINE TELEVISION

THE recent report of the "television committee" in England and the feverish activities of several German companies in the installation of high-definition television facilities have caused a notable flood of material to appear in radio magazines in these two countries.

The photo in Fig. A is reproduced from a recent issue of WIRELESS WORLD. It shows the projector installed by the Baird Company in the Crystal Palace in London. This projector is used for the 180-line film transmissions which will gradually replace the 30-line pictures sent out now by the B.B.C. It is explained in WIRELESS WORLD that high-speed scanning of film presents fewer difficulties than the transmission of actual scenes and objects.

This set appeared recently in RADIO WELT.

BRIGHTER CATHODE-RAY IMAGES

BECAUSE of the limited light intensity of most cathode-ray television scanners which limits the enlargement possible, television engineers have tried numerous schemes to improve the brilliancy of the received images.

One promising method which was described in a recent issue of POPULAR WIRELESS is a combination of the cathode-ray tube and the glow-discharge type of tube. As shown in Fig. 1, a cathode-ray scanner is provided with a special partition, and the end, which is usually coated with the fluorescent material, is filled with an inert gas (such as neon, helium, etc.).

The partition consists of a large number of fine wires (W) placed side by side in the direction of the axis of the tube, each wire being insulated from the rest.

An open wire gauze is placed near the partition and is supplied with a high positive potential. The cathode ray, sweeping over the surface of the partition, makes contact one by one with the fine wires and each one acts as a kind of "switch," to complete the circuit across the gas-filled space to the wire screen. Each "point" then sets up a glow in the gas, as the ray passes.

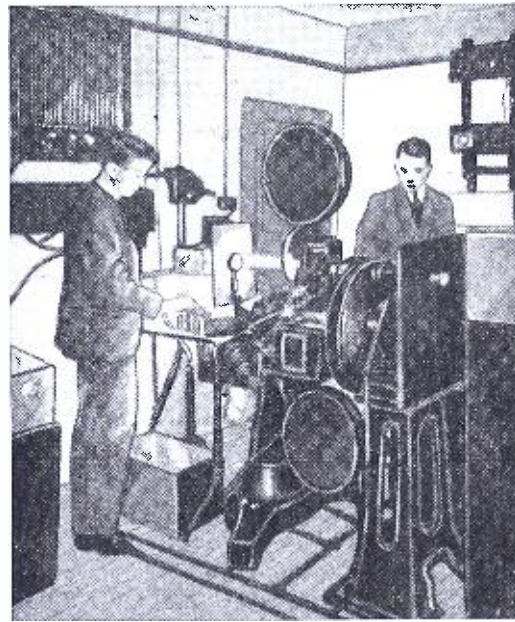

Fig. A. The 180-line film television in the Crystal Palace, London.

As the light thus produced is more intense than that produced on a fluorescent screen, the picture can be enlarged considerably by means of lenses without serious loss of "detail."

30-LINE TELEVISION

AS a contrast between the present receivers used in England and the newer cathode-ray types being made for the 180-line transmissions, the "me-
(Continued on page 108)

TELEFUNKEN TELEVISION RECEIVER

AS explained elsewhere in this issue, the Telefunken Company in Germany is manufacturing a new type of cathode-ray television receiver to pick up the transmissions of the ultra-short-wave television stations which have been erected there. This set, shown in Fig. B gives reception of both sight and sound and is synchronized by "synchronizing impulses" superimposed on the picture transmissions. A high-vacuum type of cathode-ray tube is employed.

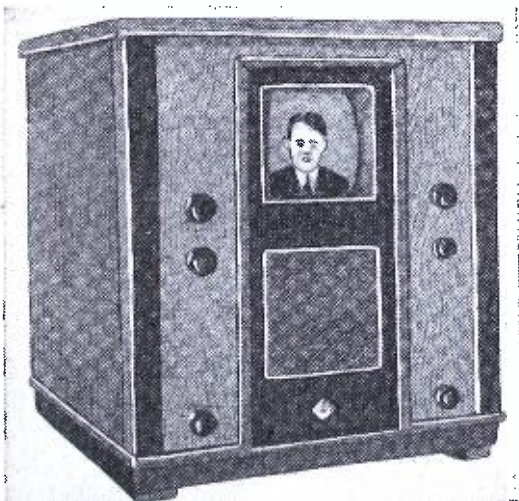

Fig. B. The Telefunken cathode-ray set.

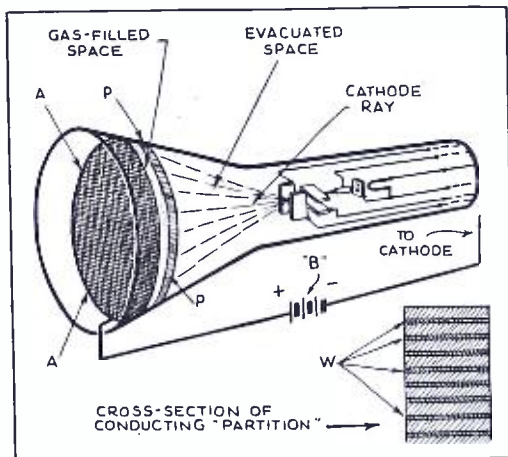

Fig. 1. Intensifying the cathode-ray image.

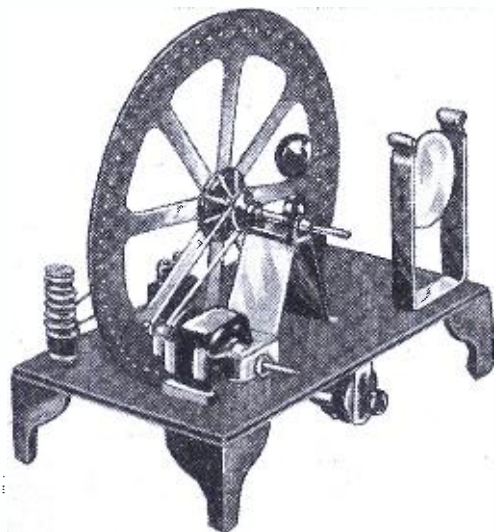

Fig. C. A mechanical scanner for the 30-line pictures. This is a kit type unit.

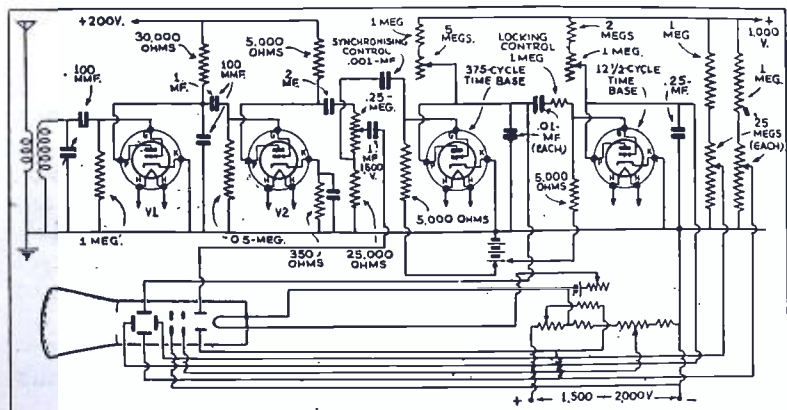
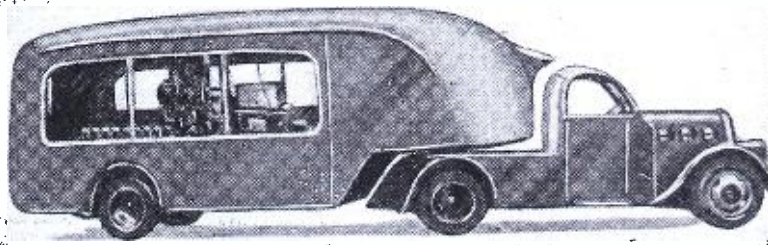
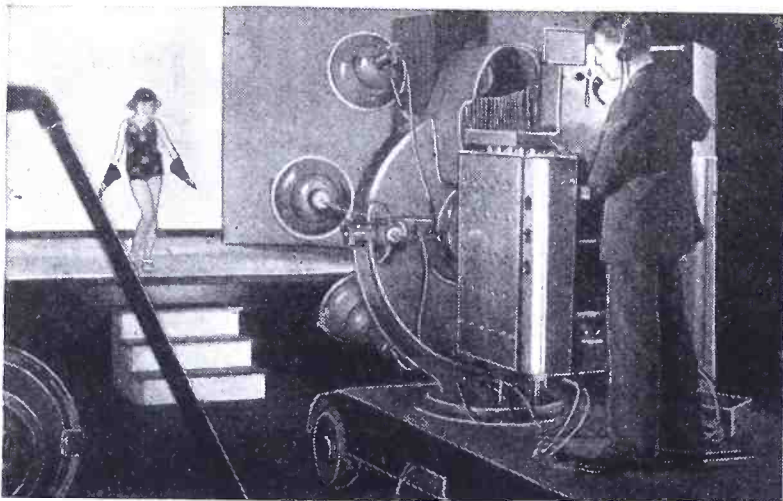

Fig. 2. A complete cathode-ray television receiver for 30-line pictures. The "B" power is obtained from well-filtered power units.

Fig. D. The Loewe television "van" which films events and then televises the films.





The Sanabria 10-band televisor in action.

TELEVISION IN THE SCHOOL

Even though television is not "here" commercially, it is advisable to study the subject thoroughly.

J. A. ROBINSON*

"radio" skill, it is particularly well adapted in nearly all of its phases to the capabilities of the trained radio expert. With this in mind, the school has developed a completely equipped television laboratory in which students build special resistance-coupled short-wave receivers and amplifiers for television signal reception, assemble kit-type televisors, operate and test factory made experimental televisors, and transmitting units.

One of the accompanying photos shows a film scanning machine used for televising motion picture films. This branch of television has unusual possibilities for future development of motion pictures in home use as well as in the production of suitable television entertainment. Many television engineers feel that some of the difficulties of television "pick-up" can be solved by means of the highly developed motion picture camera to photograph entertainment features. The film can then be televised under proper speed and light conditions in the transmitting room.

Another interesting development is the 10-channel television scanner, amplifier and televisor unit developed by U. A. Sanabria, which is claimed to be capable of greater efficiency in handling the wide frequency range of television signal impulses. This machine divides the band of signal impulses over 10 separate photo-cells, 10 individual amplifiers, and a huge 10-element light source at the reproducing end. A surprising improvement in detail and light

(Continued on page 108)

A FEW YEARS ago when Coyne Electrical and Radio School commenced a course of instruction in television as part of the radio shop course, many individuals expressed their skepticism of the commercial value of such training and questioned the advisability of devoting the necessary time to a study of "visual broadcasting."

Today, in view of the recent striking developments in television technique and the active support of leading commercial interests, many men who are employed in radio service, sales and operating jobs, are thankful for the foresight that is now making it possible for them to capitalize on their practical television experience. Television has never been offered as an immediate means for profitable employment even though some technicians have already made gainful use of their television training in laboratory jobs or in personal research and experimentation in this field.

Inasmuch as television incorporates about 90 per cent

*Exec. Director, Coyne Electrical and Radio School.

AN 8-TUBE SHORT-WAVE KIT-SET

This receiver covers all the short-wave broadcast and amateur bands—it is a high-class receiver for the discriminating amateur and short-wave listener.

S. O. LAWRENCE*

THIS short-wave set has been prepared exclusively for the trade requiring a high quality and dependable short-wave receiver. It has been prepared with the necessary precision for a commercial and professional short-wave receiver and for the amateur who is interested in a short-wave set of outstanding performance.

CONSTRUCTION

The inductances L1 to L12 constitute the short-wave assembly and are completely wired up in the multi-wave unit, used in conjunction with a 3-gang, 140 mmf. tuning condenser.

Band Coverage: Band No. 1—18 to 9 mcs. Band No. 2—9½ to 5½ mcs. Band No. 3—6 to 3 mcs. Band No. 4—3½ mcs. to 1600 kc.

Special I.F. units of 507 kc. have been designed expressly to be used with the coil combination. They are of the series wound type, extremely selective and of high gain. These coils are particularly adaptable to this type of receiver, since they eliminate interference from

broadcast signals, improve the image ratio of the set and prevent the oscillator from having any tendency to be drawn into resonance with incoming signals.

The simplest method for lining up the set would be to use a service oscillator, working at a frequency of 507 kc. To line up the I.F. units and beat oscillator, the grid cap is removed from the 2A7 tube and a lead connected from the service oscillator through a small

The appearance of the kit set completely assembled.

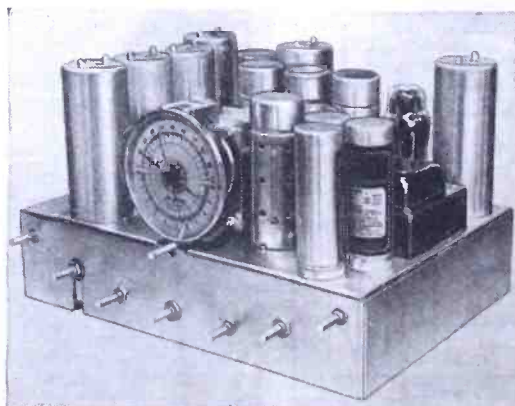

condenser of about 100 mmf. capacity. (A grid-leak of approximately ¼-meg. should be connected from the grid of the 2A7 tube to the chassis to provide a grid-leak for this tube while the I.F.s. are being aligned.) The I.F. units having been peaked at 507 kc., turn on the heterodyne oscillator and adjust the screw through the top of the shield until a zero beat is obtained in the speaker.

To proceed with the aligning of the R.F. end of the set, connect the service oscillator output lead to the antenna post farthest away from the ground post. The ground lead of the oscillator is hooked to the ground post of the chassis to which is also connected by a short jumper the remaining antenna post. Turn the band-selector knob to band No. 4 (3.2 mcs. to 1.6 mcs.) and set the oscillator at 3,000 kc. Then adjust set-oscillator trimmer until this frequency is brought into the correct position on the tuning dial. A slight amount of adjustment should be all that is necessary. In the same manner adjust the interstage and antenna

(Continued on page 110)

*Manufacturers name on request.

A CONVERTIBLE AUTO-TYPE P.A. SYSTEM

Here is an auto-type P.A. unit which may be operated from the A.C. lines by a simple change. HUBERT L. SHORTT*

IN CONDUCTING a course of technical instruction on sound systems for a large group of radio Service Men during the past winter, the writer had the opportunity to question many practical, independent service specialists, and learned some interesting things about their use of portable P.A. amplifiers in the field.

It seems that most automobile-type amplifiers are used only a few weeks during the year, usually for ballyhoo purposes around election time, and that they gather dust for the rest of the time. Occasionally a ballyhoo job for a merchant running a sale will turn up, but in the main,

The units which comprise the auto P.A. system, described.

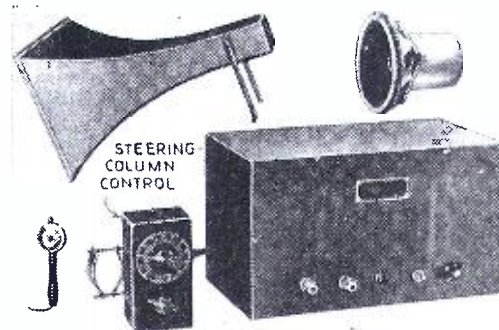

election time is the real "season." The Service Men's complaint is that an amplifier for this irregular amount of business represents a considerable investment and that it takes a couple of years to pay for itself.

What is needed, say these men, is a sound system of greater flexibility. It should not be limited in application to automobiles alone, but should be capable of A.C. operation as well, so that it can be used indoors during the winter for lodge meetings, card parties, dances, and similar affairs. Thus the income from these rentals will help pay off the cost of the apparatus very quickly, and everything from then on is so much "velvet."

Very fortunately, the growing standardization of the 6.3-volt types of tubes has made the design and construction of such a fully-convertible amplifier system altogether practicable. A technical description of one such system, designed by the writer, may be of interest to Service Men who like to keep informed on developments relating to their business.

The primary idea was to make the system a one-man outfit, suitable for easy installation in the family "bus," which serves as transportation for the majority of Service Men. Simplicity of control was another important consideration, as the Service Man (Continued on page 111)

*Chief Engineer, Wholesale Radio Service Co., Inc.

The amplifier and the two "B" power supplies.

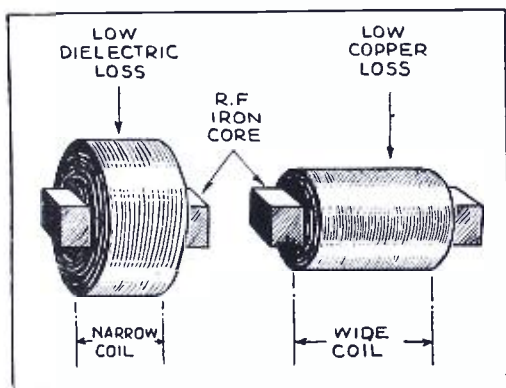
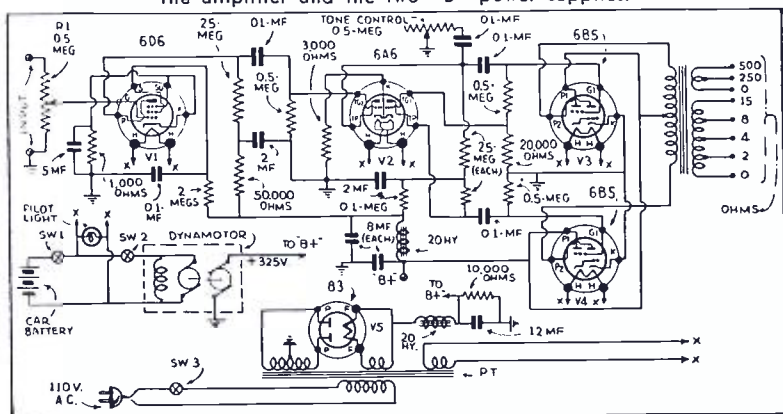

Two of the major problems in ferrocart antenna-coil design.

(Turret-top cars demand much in set performance. This story of how one well-known coil laboratory has met the demand should appeal to every radio man. The data is fundamental, and applies also to "regular" sets. —Ed.)

THE MOST important performance factors of a radio set, sensitivity, selectivity, fidelity, image ratio and signal-to-noise ratio, are largely dependent upon coil design.

Certain of these factors, it is true, can be influenced to some extent by other components. As examples, radio sets that have a very sharp I.F. system (giving poor high-frequency response) can be partially compensated by special A.F. systems which have high gain in the high-frequency spectrum, and more moderate gain in the middle and bass

THE HIGH-GAIN ANTENNA STAGE

In auto-radio sets, and home sets of medium size, improvement narrows down to better coils—using iron cores. RUSSELL M. BLAIR AND JEAN BRAND*

register; or the sensitivity can be influenced by the total amount of gain in the audio system. However, as a general statement, the above is relatively true and we will, therefore, consider what general improvements can be made in the performance of radio sets by changes in coil design.

The "popular" broadcast sets have five tubes, lining up about as follows: 1—combined oscillator and first-detector, usually type 6A7; 1—I.F. stage, either 78 or 6D6; 1—combined A.V.C. and second-detector, using a 75; 1—A.F. output tube, a 41 or 42; and 1—rectifier, a 25Z5 or an 80. (Some sets, of course, employ 2.5 V. tubes equivalent to those just mentioned.) Having this limited number of tubes, certain factors in coil design are practically fixed by performance considerations. The I.F. system having but a single stage must have the highest possible gain that can be obtained with reasonable selectivity. When this requirement is satisfied, there are left only the antenna and oscillator coils in

which changes might improve the overall set performance.

The oscillator coil design is dictated largely by space and economic considerations. This coil most generally is a small (relatively inexpensive), universal-wound coil. If a much better coil (i.e., a large-diameter solenoid) were to be used, some improvement in translation gain might result but as far as the overall set performance is concerned, this change should be reflected only in an increase in sensitivity, the equivalent of which can be accomplished in the audio system. The antenna coil, therefore remains the most fruitful field for improvement.

ANTENNA COIL IS MAJOR SENSITIVITY FACTOR

Antenna coils as they are now constructed, particularly for automobile sets, are relatively small in size. This small size, especially if the coil is shielded, results in low efficiency. The type of coil most generally used for the smallest (Continued on page 112)

*Melssner Mfg. Co.

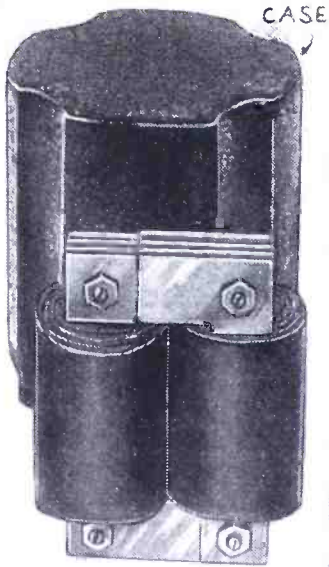

THE DESIGN OF TELEVISION TRANSFORMERS

High-quality iron-core A.F. transformers offer advantages over resistance-capacity coupling, as the author points out.

LEON J. LITTMANN*

Left, Fig. A. The new transformer removed from its high-permeability case (in the background). Below, Fig. 1. Circuit and characteristic curve of a resistance-capacity coupled A.F. stage.

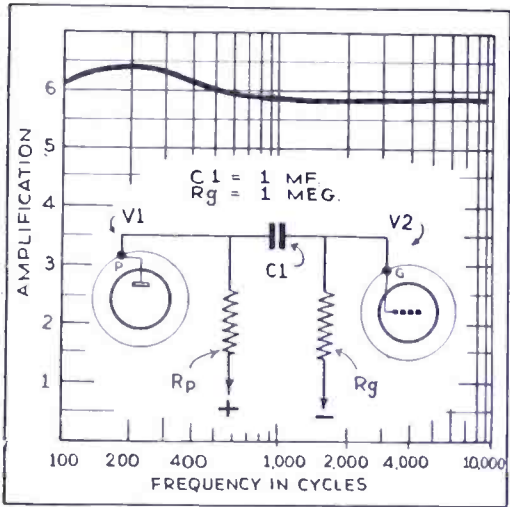

IN ORDER that an amplifier may be used for television purposes, it should not only amplify all the audible and super-audible frequencies involved, but should amplify them all *with equal intensity* and without the introduction of spurious frequencies.

Heretofore, resistance-capacity coupled amplifiers were employed almost exclusively. This was due mainly because there were no satisfactory A.F. transformers available to the public, and therefore resistance-capacity coupled amplifiers were generally found to give better results than transformer-coupled circuits.

The conclusion should not be drawn, however, that resistance-capacity coupled amplifiers are distortion-free or that they amplify both very low and very high frequencies. In fact, *just the opposite is the case*. Resistance-capacity coupled amplifiers are definitely limited in these two respects!

*Consultant Eng., Alloy Transformer Co.

FIDELITY LIMITATIONS IN RESISTANCE-CAPACITY COUPLED AMPLIFIERS

Let us consider for a moment one stage of resistance-capacity coupling, as shown in Fig. 1. The signal voltage built up across R_p is impressed through C_1 upon R_g building up a charge on condenser C_1 which discharges through R_g . The values of C_1 and of R_g should be chosen in such a way that this dis-

Fig. 3. Eliminating hum pick-up.

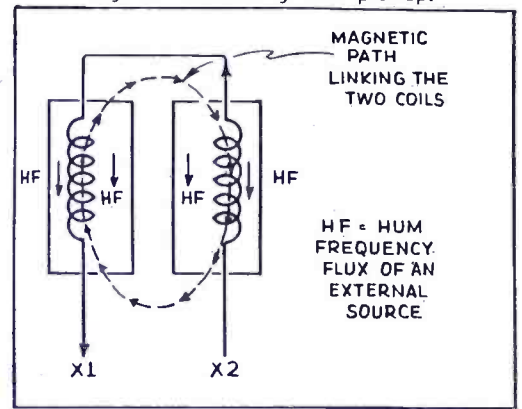

A NON-MOTOR BOATING HIGH-GAIN AMPLIFIER

The choice of coupling condensers and resistors, as well as a special screen-grid bias arrangement permits high gain without instability.

H. F. SHEPARD, JR.*

WHEN ONE builds high-gain A.F. amplifiers one of the greatest problems, and yet one quite easy to solve, is to make an amplifier that will have a good low-frequency response and yet be free from motorboating effects. It is desirable to avoid the use of separate "B" supplies or extremely large "B" filters. Obviously the proper way to accomplish this is to build an amplifier that has a very sharp low-frequency cut-off and to use it in connection with individual "B" supply filters so that any frequencies that are passed through the "B" supply filters will not be amplified, and any frequencies that are amplified will not be passed between stages through the "B" supply filters. The sharper the low-frequency cut-off of the amplifier the easier it will be to provide suitable "B" supply filters to stabilize it.

A stable high-gain amplifier can be built using pentodes

*RCA Radlotron Div., RCA Mfg. Co., Inc.

Fig. 1. The circuit of the amplifier, using pentode tubes with a careful choice of coupling values and the use of degeneration in the screen-grid circuits.

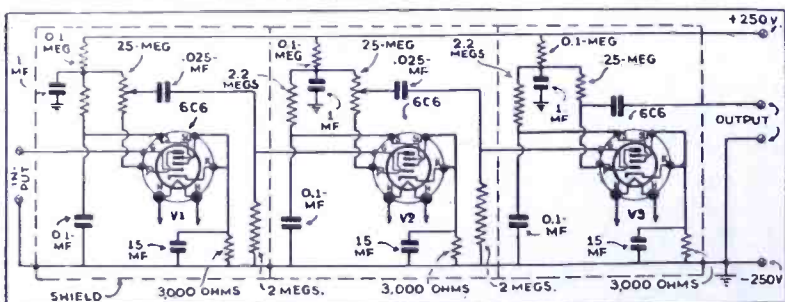

in a resistance-capacity coupled circuit having a fairly sharp low-frequency cut-off.

FACTORS LIMITING L.F. GAIN

The screen-grid voltages are fed through series screen-grid resistors shunted by the tube impedance and bypassed directly to ground by suitable condensers.

At very low audio frequencies, the impedances of these condensers are relatively high, their bypassing effect is low, and the loss of gain in the amplifier, due to degeneration in the screen-grid circuits, is great. At high audio frequencies, the impedances of the condensers are relatively low, the degeneration is low, and the gain of the amplifier approaches the gain it would have if the screen-grid voltages were absolutely fixed.

In a like manner, the gain of the amplifier is reduced at low audio frequencies by the lack of sufficient bypassing effect of the cathode bypass condenser, which bypasses the self-bias resistors effectively paralleled by the cathode impedances of the tubes. There is also a loss of gain at low frequencies in the coupling resistor-condenser combination between stages. The loss approaches zero as the frequency rises, and approaches infinity as the frequency is lowered.

By properly proportioning all the above-mentioned condenser-resistor combinations, it is possible to make all of the degenerative effects start to occur at the same frequency. This results in a sharper than usual low-frequency cut-off which helps, as explained above, to make the am-

(Continued on page 117)

A BI-DIMENSION P.A. AND TELEVISION AMPLIFIER

Description of a 40-watt, twin-channel amplifier, utilizing the new "metal," and newer "glass-metal" tubes.

CHARLES R. SHAW*

WHEN YOU measure the progress in convenience, adaptability, and fidelity of reproduction brought about in the past five years of P.A. development, your first thought may be that there is nothing left to discover in the future. But the truth of the matter is that few commercial amplifiers meet all of the demands made of them today!

Let us for a moment briefly review some of the more important features which should be found in every modern amplifier:

- (1) Ability to amplify in true auditory perspective.
- (2) Ability to simultaneously amplify two separate programs or interrelated signals (television images and accompanying sound).
- (3) Adequate power output.
- (4) Wide range (variable output).
- (5) High gain.
- (6) Dependability (reserve channel).
- (7) Freedom from phase, amplitude and directional distortion.
- (8) High- and low-frequency attenuators.
- (9) Universal input circuits.
- (10) Universal output circuits.

*Design Engineer, Columbia Sound Co., Inc.

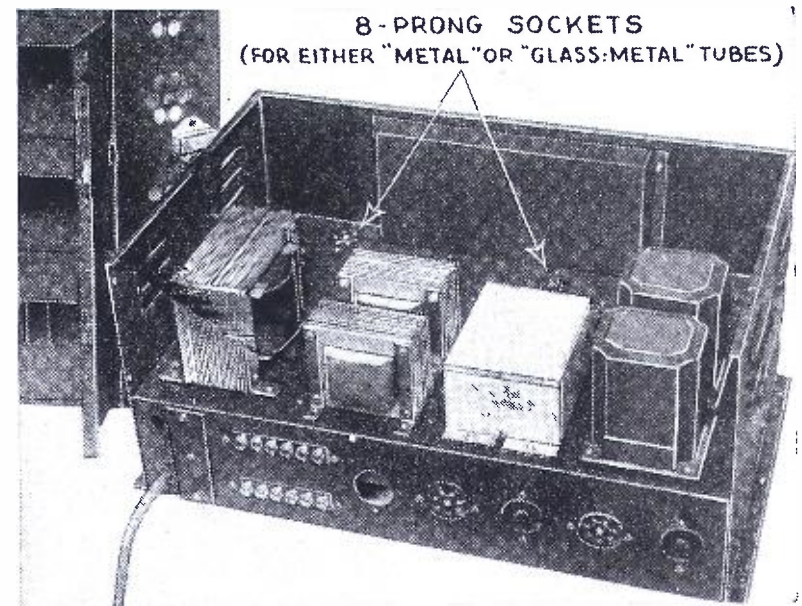
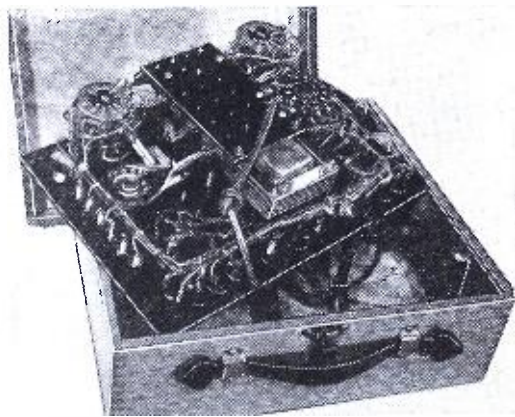

The interior of the amplifier showing the shield compartments which prevent interstage coupling.

- (11) Utilize the most efficient tubes in modern circuit arrangements.

The amplifier illustrated is representative of a typical modern device which incorporates all of the desirable features listed above and finds a ready application to all forms of P.A. rental and sales work. As noted in Fig. 1 it is essentially composed of two clear A.F. channels each one of which utilizes four of the latest type tubes; 1-6K7 triple-grid super-control metal amplifier tube in the first stage; 1-6C5 high-mu metal triode tube in the second stage and a pair of 6B5 high-fidelity class A power amplifiers in the output push-pull power stage. The output of each channel terminates in an independent universal-output transformer tapped at 500, 200, 15, 8, 4, and 2 ohms for all standard combinations of voice-coils and lines.

Both of these channels are (Continued on page 113)

A TEST UNIT FOR SOUND SYSTEMS

The ranges and uses of this unique test instrument are described here in detail.

PART II

HAROLD H. SHOTWELL*

IN ORDER that space, weight, and final cost shall all be as low as possible, a single D.C. meter with associated rectifier was selected in place of a separate meter for A.C. measurements and another for D.C. measurements. The meter sensitivity was chosen so as to give a full scale deflection with a current of 200 microamperes. This gives readable deflection on currents of the order of 2 to 4 microamps, or better, such as encountered in "talkies" PE.-cell circuits. Refer now to Fig. 1 (See preceding issue.—Ed).

Figure 1A is the basic current measuring circuit. R_m is the meter resistance, R_{se} is the series arm of the total shunt resistance R , R_{sh} is the shunt resistance portion of R , i is the current through the meter, and I is the current being measured.

By means of a multi-point switch, the proportion of R_{se} to R_{sh} is varied from 0, ($R_{se} = 0$, and $R_{sh} = R$), to several thousand, in order that I may vary from a few milliamperes to several amperes.

*Supreme Instruments Corp.

CURRENT MEASUREMENTS. The currents to be measured vary in magnitude from a few microamperes to at least 10 A. Obviously, this great range cannot be covered by one meter without resorting to multipliers.

R_m is the total meter resistance, including a calibrated resistor in series with the actual moving coil so as to raise the combined resistance to a predetermined value, thus allowing the other circuit constants to remain fixed.

VOLTAGE MEASUREMENTS, D.C. VOLTAGES. The highly sensitive meter is readily adaptable to the measurement of low and high D.C. voltages, by using proper series multipliers for absorbing that portion of the voltage which is not required across the meter.

Desiring a resistivity of at least 1,000 ohms per volt, and with a low-range scale of 0 to 5 V., we find our circuit resistance, including the meter resistance, to be 5,000 ohms, and the circuit current to be $5 \div 5,000$ or 1 ma. But 1 ma. will produce a 400 per cent

(Continued on page 116)

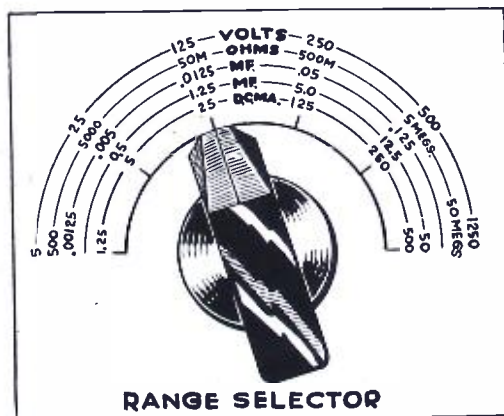
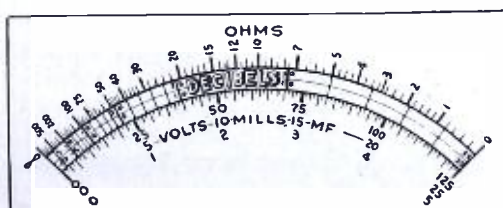
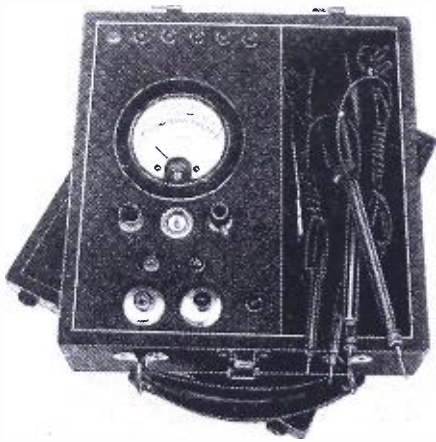

Fig. 2, above; and Fig. 3, below.





A VERSATILE WIDE-RANGE CONDENSER TESTER

This tester will test condensers from .00005- to 16 mf. It may also be used as a multimeter.

J. R. WILLIAMS*

THE CONDENSER tester described here has several features which make it particularly attractive to the Service Man. Its wide capacity range from .00005- to 16 mf. permits testing practically any condenser used in a radio receiver, amplifier or other electronic device. In addition, the 0-1.ma. meter which is used for capacity checking on the .1- to 16 mf. range is provided with a milliampere scale and its terminals are brought out to tip-jacks so that it may be used with external multipliers for current and voltage measurements—thus making a multimeter of any desired range.

CONDENSER TESTING .1- TO 16 MF.

- (1) Insert probes into jacks 1 and 2.

*Manufacturer's name on request.

- (2) Connect probes to object condenser.

- (3) Press button and hold down.

Meter needle will go to capacity of condenser and return completely to zero if good. If any reading is maintained, it indicates leakage. Replace.

If capacity kick is beyond the 4 mf. scale, turn toggle switch to 16 mf. scale. If needle remains off scale the condenser is shorted. (Note: When testing a condenser in a radio set, it may be shunted by a resistor, etc. If the circuit is not well known, open up one terminal of the condenser, if in doubt.)

Quantities of condensers can be tested quickly without the probe leads, by holding the condenser terminals against the two nickel-plated touch plates.

Electrolytic condensers. Always connect (red) No. 1 jack to positive terminal of the condenser. There is always an inherent leak in electrolytics, but this should not exceed 10 per cent of the kick.

CONDENSER TESTING .00005- TO .05 MF.

- (1) Insert probes into jacks 1 and 3.

- (2) Connect probes to object condenser.

- (3) Press button and hold down.

If condenser is good the neon glow lamp will give a low glow. If shorted or leaky, a bright glow. If open, no glow.

Continuity. Insert probes into jacks 4 and 5. It is (Continued on page 117)

The circuit of the condenser tester and multimeter.

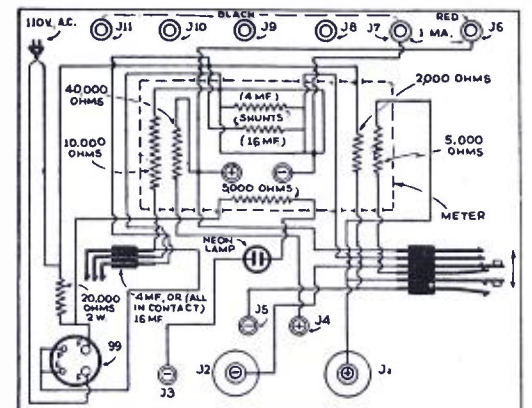

USES OF THE CATHODE-RAY OSCILLOSCOPE

Here are some really practical suggestions for radio men who intend to use an oscilloscope.

F. M. PARET*

PART I

WITH RECENT improvements in the design of cathode-ray oscilloscope tubes, many new uses have been found for this versatile measuring instrument. The radio Service Man, for example, has found it to be a superior indicator in many of his jobs. A few of these applications are described briefly, below.

The simplest method of alignment in using an oscilloscope is to apply it as a voltage measuring instrument and to align each stage for maximum voltage output. This method does not indicate band width or tell whether all stages are tuned to the same frequency, but it has advantages over other meth-

ods in that overload characteristics of the detector do not enter, and that the alignment operation may be performed in complete silence—the signal need not be modulated and consequently no sound will emanate from the speaker. Or if it is desired to use modulation, the volume control may be turned down or the reproducer voice-coil disconnected.

The stages may be aligned individually or together, using one or two stages of amplification as required. The customary method is to connect the test oscillator in the control-grid circuit of the tube preceding the coil to be aligned and to connect the vertical plates of the oscilloscope across the coil in the plate circuit of the tube following the coil under test. In this way no extraneous lead capacities are placed in the circuit of the coil.

RESPONSE OF A.F. AMPLIFIERS

Since the cathode-ray oscilloscope is independent of frequency, a more accurate fre- (Continued on page 114)

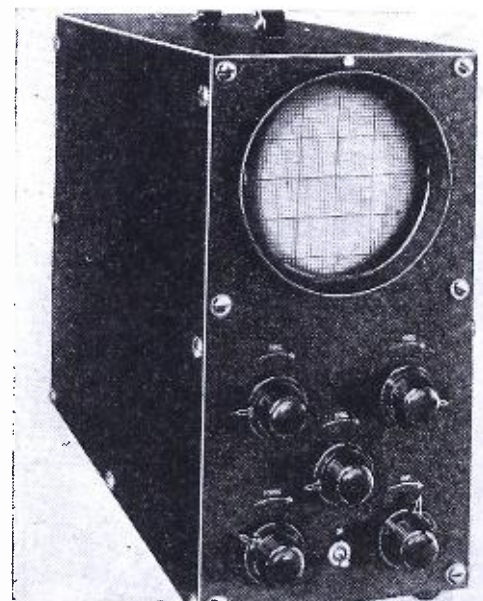

Above, the appearance of a new oscilloscope unit, ready for operation. Below, the circuit of the unit shown above.

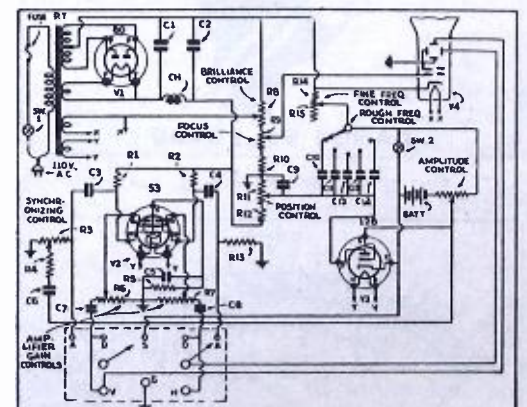

*Sales Eng'r, National Union Radio Corp. of N. Y.

The method of connecting the panel of the oscilloscope for oscillator testing.

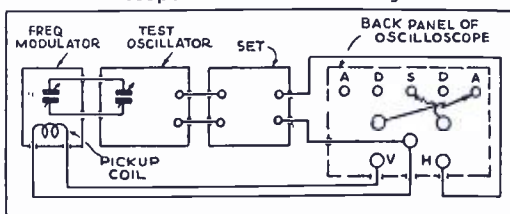

HOW TO MAKE A SIMPLIFIED "TREASURE" LOCATOR

This new, simplified metal locator eliminates the "bugs" inherent in previous, more complex designs. It works!

HARRY L. BERRY*

IN THE past, many electrical instruments have been used to locate underground minerals, metal ores, and buried metal. Unfortunately, many of these devices have faults which defeat the very purpose they were designed to fulfill.

*Manager, Oro-Scope Sales.

The circuit of the detecting device, with the values of parts indicated.

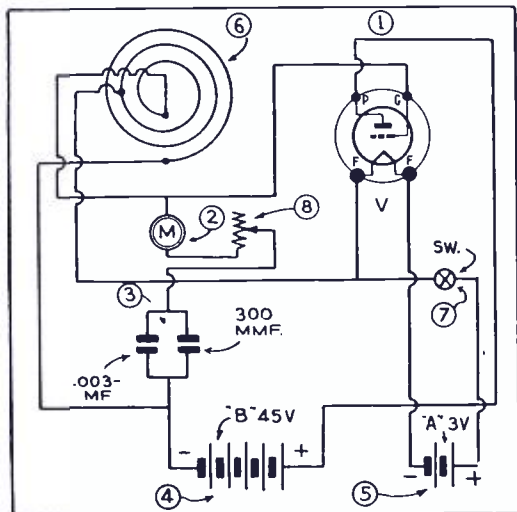

The outstanding fault with units which operate at high frequencies is the fact that they give the same indication for water as they do for metal. Further, metal ores, salts and even some non-metallic substances are detected the same as metals. A green bush in an arid section would lead the prospector to believe that metal had been detected.

The presence of metal on the person of the operator has been a source of trouble, making rubber boots necessary—as well as a careful check through clothing for metal buttons, etc.

The use of a low frequency (super-audible audio frequency) in the instrument described here eliminates these difficulties. This device does not indicate the presence of water. In fact, it may be operated under water, a feature which opens up new fields in electrical prospecting.

Much space has been given in technical magazines to the subject of locating buried treasure, metal ores and the like, and many unfounded theories have been originated to the confusion of those
(Continued on page 115)

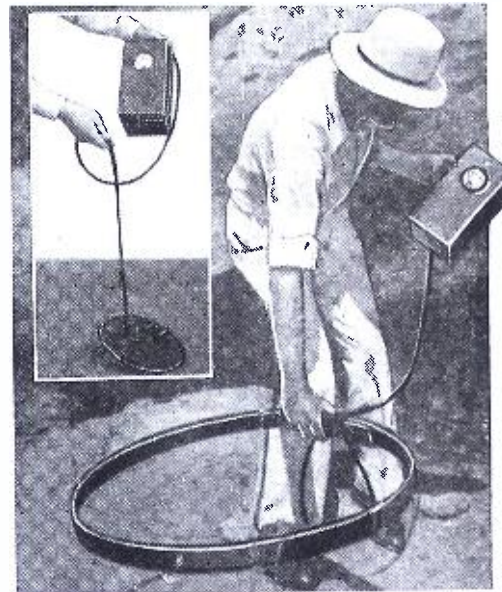

Above, unit in operation. Below, interior view

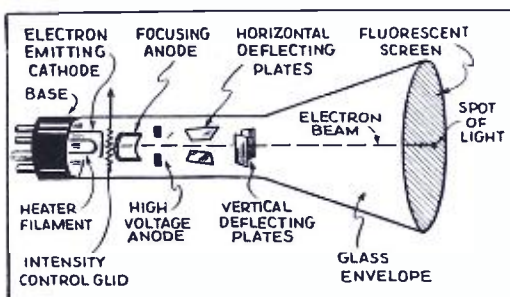
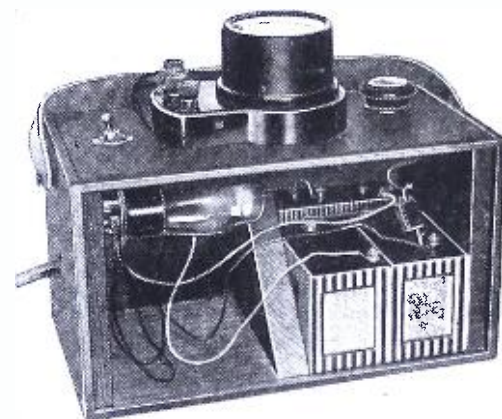

Fig. 1. The elements of the tube.

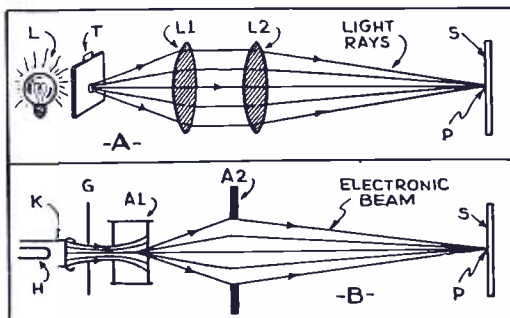

Fig. 2. The analogy of focusing light and cathode rays is illustrated.

THE MODERN form of cathode-ray tube consists essentially of six main parts. These are: (1) A filament which serves to heat the cathode. (2) The cathode from which the electron stream is emitted. (3) A device for concentrating, controlling and focusing this electron stream into the form of a fine beam. (4) An arrangement for deflecting the beam (either electrostatically or electromagnetically). (5) The fluorescent screen or target which emits

*Radio Technical Pub. Co.

THE FLUORESCENT SCREEN IN CATHODE-RAY TUBES

The author clears up some of the mysteries of cathode-ray operation in this article, particularly the screen and focusing.

ALFRED A. GHIRARDI*

light when struck by the electron beam. (6) The glass envelope into which all the foregoing parts are sealed for the maintenance of a vacuum.

In this part of the discussion, we will consider only items 3 and 5 of this tabulation. The general operation of the cathode-ray oscilloscope has been described in past issues of RADIO-CRAFT (See April, 1935 and May, 1935 issues—"Fundamental Facts About Cathode-Ray Tubes."), but there exists a certain amount of mystery in the minds of some readers about the "screen" and the formation of a "sharp" beam, which we will try to dispel here.

On their way from the cathode to the anode the electrons are acted upon by the intensity control grid, G. (See Fig. 1.) The bias voltage applied to this control grid is made variable to provide a means of controlling the intensity of the electron stream.

As the electrons leave the cathode there is a tendency for the beam to

spread out, fan-shaped, as it travels toward the screen. This spreading out is caused by the mutual repulsion of the individual electrons of which the beam is composed, since they are really all negative electrical charges and "like" charges repel each other. It is necessary to prevent this spreading out of the electron stream; in fact in order to get only a tiny spot of light on the fluorescent screen, S, it is necessary to actually focus the electron stream to a fine, sharp point at the screen, much the same as the light rays from an incandescent lamp, L, may be focused to a point, P, on a screen, S, by means of the two lenses L1 and L2 as shown at (A) of Fig. 2. The amount of light may be controlled by the shutter T, which when closed completely shuts off the light. The size and definition of the image on the screen S are controlled by adjusting the position of the lenses to the correct distance. This is
(Continued on page 115)

THE ANALYSIS of RADIO RECEIVER SYMPTOMS

OPERATING NOTES

THE PURPOSE OF THIS DEPARTMENT

It is conducted especially for the professional Service Man. In it will be found the most unusual troubles encountered in radio service work, written in a practical manner, by Service Men for you.

Have you, as a professional man, encountered any unusual or interesting Service Kinks that may help your fellow workers? If so, let us have them. They will be paid for, upon publication, at regular space rates.

A.K. 40

SET dead on receipt. Cause, double open in the 71A 2,200 ohm bias resistor and in the 625 ohm section of this same resistor, and in each case at the end of the terminal. This is a flat wire-wound resistor. After replacement, the set was noisy. This was caused by the following: dirty contact on volume control, dirty condenser bearings and an open in the 65,000 ohm detector plate supply resistor which developed only after several hours of operation. The volume control can be cleaned by removal and then sanded lightly with very fine sandpaper and by bending the rotor arm so as to give a firmer contact. Condenser contacts are cleanable only by disassembly until the bearing surfaces are exposed. Replacement cured noise due to the intermittent open in the 65,000 resistor. Details are shown in Fig. 1, below.

JOHN MUEHLKE

STEWART-WARNER 950

ON this set the screen bypass condenser and the volume control were burned out. (It seems likely that the failure of one caused the breakdown of the other, but which went first is a mystery.) An inspection of the circuit at A in Fig. 2 will show that when these parts are replaced, the 20,000 ohm bleeder should also be renewed. Since the set must be put in the best operating condition, we shouldn't stop here. In this set, even the best makes of volume controls are inclined to be noisy, so we put a .25-mf., 200 V. condenser between the low-potential side of the antenna coil and the ground; that is, from the antenna-coil volume control connection, to ground. (Even when the volume con-

trol is not noisy, this tends to give more uniform control of volume on this model.)

SILVER-MARSHALL F

IN THE Silver-Marshall model F, 7 tube set, it is considered advisable to replace the 10,000 ohm, 2 W. resistor feeding the screen-grids with an equivalent value of a 5 W. rating. This is nearly always a trouble spot. Another potential source of grief is the 3-section bypass condenser. It might as well be changed for it probably will burn out the next day! The plate section is rated at 1. mf. 300 V., and the screen-grid section at .5-mf. 200 V. When the set is first turned on both plate and screen-grid voltages exceed these ratings. A section of the circuit is illustrated in B of Fig. 2.

THOMAS C. RUMNEY

MOTOROLA 44

RECENTLY a customer, who had a Motorola 44 in an Oldsmobile, complained of noise when the car was in motion or when the set was jarred. It was readily seen that it was not ignition noise.

First we checked all tubes for shorts but all checked OK. The next step was checking the condensers for leaks and shorts and open and loose lugs. The transformers and resistors were also checked. So we concluded that it must be a cold solder joint and went over them all, but the noise was still prevalent. Then we went over the assembly connections to the chassis and found one metal screw in one of the coil cans had loosened. When this was tightened the noise disappeared.

PAUL L. HOSTETLER

VICTOR R6, R12

A COMMON source of trouble in the Victor R6 is the 16,000 ohm 2 W. resistor from "B" plus to the screen-grids of the R.F., 1st detector, and I.F. tubes. It breaks down to a low value and thereby overloads the 8,000 ohm 1 W. resistor connected from screen-grid to cathode, located directly at the socket of the I.F. tubes. It is wise and usually necessary, to replace both resistors, replacing the 2 W. resistor with a wire-wound unit.

While the set is in the shop, I also clean the rotor contacts on the condenser gang and bend them so that they press against the rotor with stronger tension. If the rubber friction drive slips, wind one or two layers of friction tape around it. These precautions cost nothing and prevent complaints later on.

In the Victor R12, two common complaints are oscillation and motor-boating. To correct the former it is often only necessary to clean the contacts. Motorboating may be prevented by replacing the type 47 tubes which are usually weak, and connecting a 5,000 ohm resistor in series with the screens to prevent a recurrence of the trouble.

W. WELSH

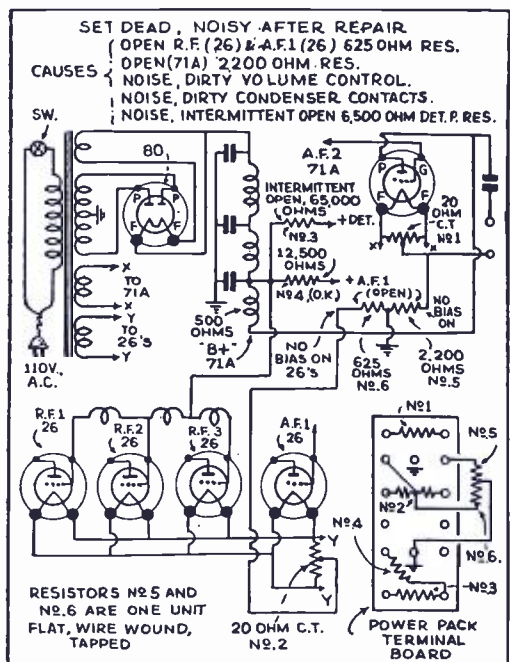
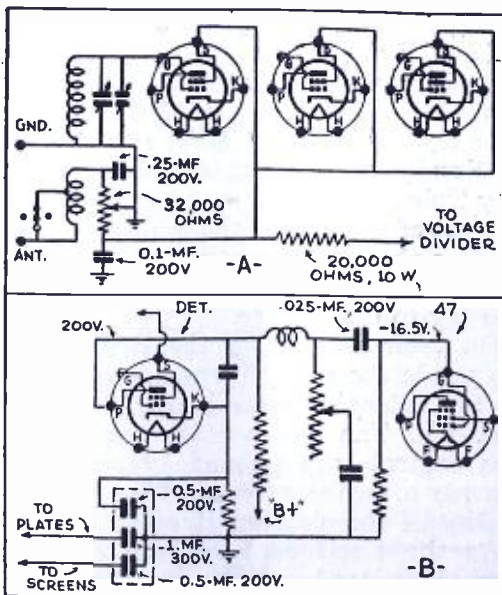

Fig. 1, left. Details of A.K. 40 troubles.
 Fig. 2, below. Stewart-Warner and S.-M. hints.



A.K. 92

THE set was brought in as "dead," and after about ten minutes of testing, reception began to come through and slowly increased in volume until after about a half-hour it seemed to play normally. The receiver played all day but was dead again the next morning! It repeated this peculiarity for several days.

Finally, I found that the trimmers on the tuning condensers were shorting due to moisture. To check the trimmers I blew on them and the signal would fade out completely. The only way the trouble could be cured was to clean them with alcohol, and to replace the mica under them. (Strips were

(Continued on page 119)

THE LISTENING POST FOR ALL-WAVE DX-ERS

A VISIT TO "RECEPTION REFUGE"—(Continued). The evening meal was finished at last and the big moment for which we had been waiting with ill-concealed impatience arrived, when our host asked us if we were ready to accompany him to the "shack." Although we were prepared for an unusual radio den, we were totally unprepared for the sight that met our eyes in this unique "Shack."

As we have before mentioned, three walls of the "shack" were made entirely of glass. The fourth or inner wall of the room was certainly the answer to a DX-er's dream. A long carved table about four feet wide ran the entire length of the room. The top of the table was covered with plates of heavy glass, such as is often seen on office desks. Starting about two feet from the front side of the table a sloping bakelite panel rose to about four inches above the table top. This served as a sort of a raised shelf for the receivers. On the sloping panel were a number of small neat button switches for controlling various combinations of aerials, speakers, and other apparatus. Several commercial receivers of the best makes set on the shelf, with only room between each for a speaker. In the center of the table and on a little shelf above the line of receivers was an odd-looking box with a black pane of glass covering the front of it. Our host explained that this was his own invention of a visual tuning indicator, which would respond to the weakest possible signal, with a mounting column of white light in contrast to the black glass. By a switching arrangement this indicator could be used in connection with tuning in any receiver as desired.

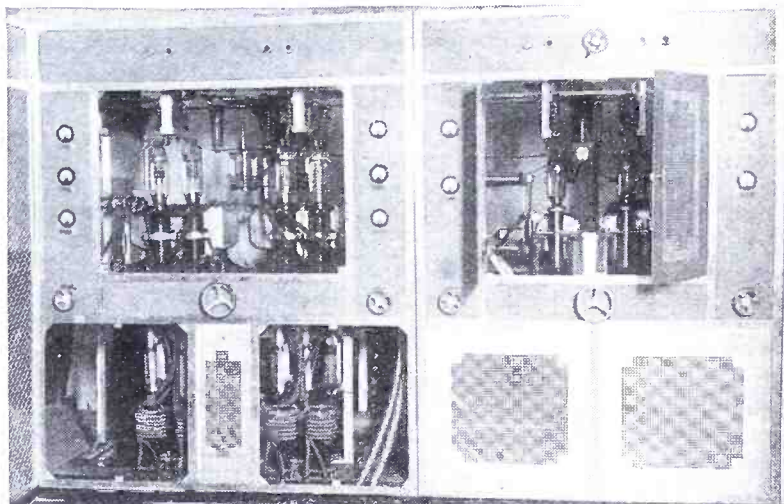

The 5kw. and 20kw. transmitter panels of S.-W. station 2RO at Prato Smeraldo, Rome, Italy.

Above the receivers and covering that whole side of the room to the ceiling was a huge detailed map of the world also covered with a pane of glass. All of the principal world radio stations were represented on this map by small electric bulbs, which could be controlled from a special switchboard at one end of the table. He told us he could use this map for a variety of purposes, and proceeded to demonstrate one of these by switching on what he called his main display. All of the stations which he had logged showed up as blue spots of light. Every continent was represented, and in some spots thick clusters of light showed his prowess as a DX-er. In fact it seemed to us that he had already received about every- (Continued on page 118)

PRACTICAL METHODS OF SERVICING "NOISE"

Practical considerations are covered in this continuation of the "noise" discussion. **PIETRO MUSCARI**

PART II

A VERY effective way to trace trouble originating from overhead power lines is through the use of a good rubber sledgehammer! When you have obtained the greatest deflection on a visual meter, or the loudest buzz, which coincides with overhead trouble tracing, a good solid blow of the sledgehammer on the pole will bring about either an increase or decrease of interference intensity. While an assistant taps the pole with the hammer, the operator listens in and

watches the visual meter of the interference set. A slight click does not mean anything:—that is to be anticipated when a slight disturbance or contact occurs. However, when the troublesome pole is struck, a "cutout" will either cease to give interference, or will show a greater intensity than before. The test set will show its deflection and its audible indication.

Another good way to locate interference is by turning on and off the differ- (Continued on page 120)

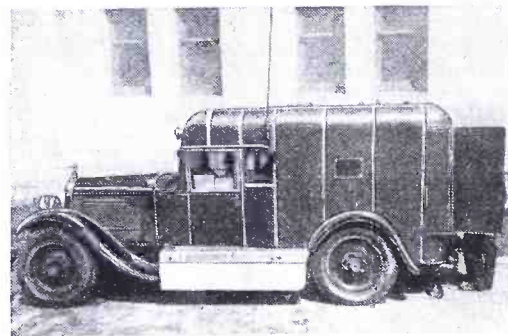

Int'l News Photo
Fig. A. A copper-sheathed rolling lab. from Harvard, used to trace interference and static!

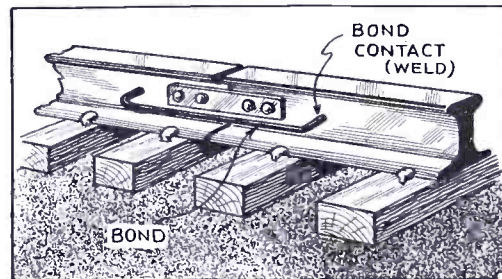

Fig. 2, above. A typical railroad bond.

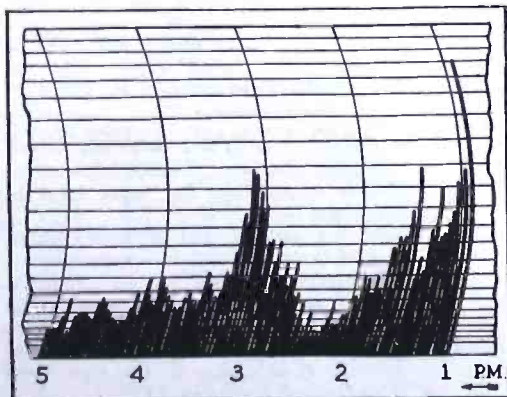
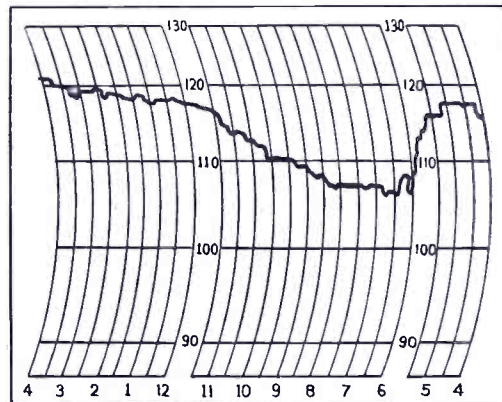
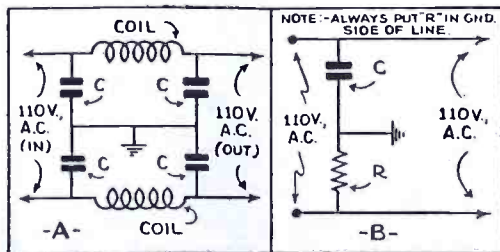

Fig. 4, left. An intermittent-noise record tape.

Fig. 3, right. A section of a "demand"-meter tape showing voltage fluctuations.

Fig. 5, below. Two types of line filters.



RADIO-CRAFT'S INFORMATION BUREAU

REMOVING PARASITIC OSCILLATION

(331) Mr. Merle C. McKee, Byron, Ill.

(Q) I am having quite a bit of trouble with a General Motors "Little General MA 110." The set does not have much volume. The tone is not very clear. I have replaced the voltage divider with carbon resistors and I have checked all voltages. On turning the volume control up about half-way, the volume drops and the stations come in at two places on the dial and very much distorted. The set has been balanced with an oscillator but it doesn't help. Volume control, bypass condensers, biasing resistors and coupling condensers have all been checked.

(A) The condition which exists in your receiver is a common occurrence with that particular set. It is caused by parasitic circuit oscillation, which is the result of a slight difference of potential in the various parts of the shielding. We recommend that the gang condenser assembly be soldered at points A, B, C and D as shown in illustration Fig. Q. 331. The pigtail is applied to the condenser shaft when the plates are fully meshed. It is also necessary for the coil wires to be straight as shown at the right of Fig. Q. 331. On the left, the two leads are shown as the set comes from the factory. It is also important that the wipers and the contact points on the shaft of the condenser be cleaned with alcohol and then a few drops of mineral oil applied. Ordinary machine or lubricating oils should not be used as they contain a certain amount of acid which has a tendency to set up the very corrosion that you are trying to eliminate. A 100 mmf. condenser shunted across the A and G posts also helps in some cases.

CIRCUIT OF CRYSTAL SET

(332) Loyd Ledbetter, Lake Dallas, Tex.

(Q) Please send me instructions on how to build a crystal set.

(A) A well-tried crystal circuit is shown in Fig. Q. 332. The inductance L and the variable condenser may be the R.F. section of an old radio set, or it can be a plug-in coil with the correct size (which is not critical) condenser. A galena crystal makes the most sensitive detector. Condenser C2 has a value of about .002-mf. Headphones should have a resistance of 2,000 ohms.

(Refer, also, to past issues of RADIO-CRAFT.)

AUTO NOISE SUPPRESSION

(333) Frank Curley, Roslyn, L.I.

(Q) I have installed a radio set in my Buick

Right, Fig. Q.7. Interference eliminator.
Below, Q331. Removing oscillations.

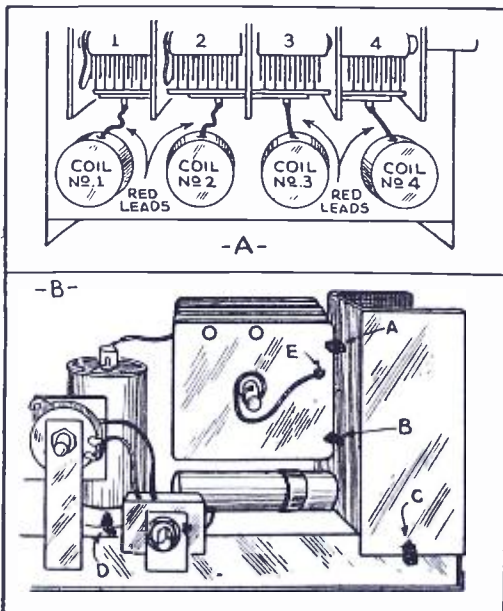

but there is quite a bit of ignition noise still present. Condensers have been installed at every point where interference was apt to occur. It is not being picked up by the antenna because I took off the car aerial and used a regular aerial in its place and the noise continued. This proves that it is coming from my electrical system. What can I make to put on there to reduce the noise still further.

(A) The filter shown in Fig. Q. 333 has been effective in blocking interference in the power supply. It consists of two 0.5-mf. paper condensers and a choke. You can make the choke out of 10 feet of bell wire (nothing smaller) which can be wound on your hand. Solder all connections and place the unit in a can. The latter should have rubber grommets in the holes where the leads come out. Solder the cover of the can to keep out dirt and moisture. The filter is then connected in the "A" lead to the receiver.

WATER LEAK DETECTOR

(334) Mr. George W. Kaess, Jeffers, Minn.

(Q) Will you please publish information on how to construct a leak finder for underground water mains, either to be connected to a hydrant or pipe grounded in some way. The mains are approximately 6 ft. underground.

(A) We do not know of any leak finder for direct connection to the water system. However the method most commonly used for detecting leaks in underground water pipes consists of a sensitive microphone and a high-gain amplifier. The microphone is mounted in a lead box, the bottom being left open. A "mike" of the ribbon type is recommended because of its distinct directional characteristics. The "mike" is connected to a high-gain amplifier (such as the one described on page 82 of this issue of RADIO-CRAFT.) A pair of headphones is connected to the output. When searching for a leak the amplifier is placed on a rubber-tired wheelbarrow and the "mike" is placed on the ground with the open end toward the water main. It is then moved along the main until the sounds of trickling or gurgling water is heard. Other sounds will naturally be picked up but when you come to the leak the sound of water will be clearly heard.

AUDIO AMPLIFIER BOOK

(335) R. Kuntner, New York City, N.Y.

(Q) Will you kindly inform me of a good book on

(Continued on page 117)

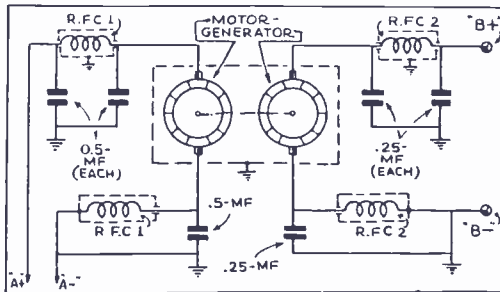

Below, Q333. Auto noise filter.

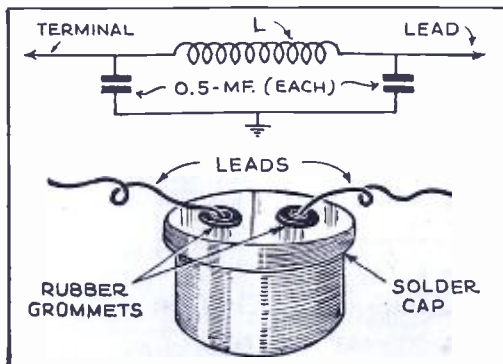

SPECIAL NOTICE

Those questions which are found to represent the greatest general interest will be published here, to the extent that space permits. (At least 5 weeks must elapse between the receipt of a question and the appearance of its answer here.) Mark such inquiries, "For Publication."

Replies, magazines, etc., cannot be sent C.O.D. Back issues of RADIO-CRAFT prior to December, 1932, are available at 50c per copy; except the following issues: 7/29, 1, 2, 3, 4, 6, 7, 9 and 11/30; 5, 8 and 9/31; and 7/33, which are out of print. Succeeding issues are still available at the regular price of 25c per copy.

Inquiries to be answered by mail MUST be accompanied by 25c (stamps) for each separate question; answers are subject to subsequent publication if considered of exceptional interest.

Furnish sufficient information (in reference to magazine articles, be sure to mention issue, page, title, author and figure numbers), and draw a careful diagram (on separate paper) when needed to explain your meaning; use only one side of the paper. List each question. Be SURE to sign your name AND address.

Enclose only a STAMPED and self-addressed envelope for names and addresses of manufacturers; or, in connection with correspondence concerning corrections to articles, as this information is gratis.

Individual designs can be furnished at an additional service charge. The fee may be secured by addressing the inquiry to the SPECIAL SERVICE department, and furnishing COMPLETE specifications of desired information and available data.

P.A. QUESTIONS & ANSWERS

MIKE HISS

(6) Mr. Benjamin Abbat, Andover, Mass.

(Q) How can I eliminate the interference caused by carbon microphone hiss?

(A.) Operate the microphone with the least amount of current flowing through the buttons consistent with satisfactory volume. Do not move the microphone while in operation. Be sure to carefully suspend it in a thoroughly shock-proof manner.

INTERFERENCE ELIMINATION

(7) N. Y. Shanen, Fort Worth, Texas.

(Q) When using high-gain amplifiers what is the best type of filter to employ for the elimination of interference caused by the use of a dynamotor "B" supply?

(A.) See Fig. Q. 7. Two 5 mhy. shielded chokes, R.F.C.1 capable of passing 15 A. should be placed in each circuit of the "A" supply with adequate bypass condensers (.5-mf. 50 V.) The high-voltage "B" supply lead and its common return lead should also be filtered with two shielded, 64 mhy. chokes, R.F.C.2, one in each lead and suitably bypassed with .25-mf. 600 V. condensers.

MERCURY VAPOR RECTIFIERS

(8) Franklin Adams, Chicago, Ill.

(Q) How can you tell when a mercury vapor rectifier of the 83 type is overloaded or operating with abnormal emission?

(A.) Under normal conditions of operation the ionized mercury assumes either a purple, or dark, pure-blue color similar to photographers' mercury vapor lamps. If the emission of the tube has dropped to below normal a distinct sea-green color prevails between the plate and filament of the tube. When the tube is overloaded, this green-colored vapor fills the entire interior of the tube.

DB. AND POWER LEVEL

(9) Mr. Edward Addicks, Philadelphia, Pa.

(Q) What is meant by the "hum level in db. below maximum output level"?

(A.) When the output power level of an amplifier is rated in "decibels," its useful operating range is sometimes limited by an abnormal hum level which prevents the maximum gain of the amplifier from being used. In order to guide technicians in the selection of an amplifier where low hum level is essential, the hum level

(Continued on page 119)

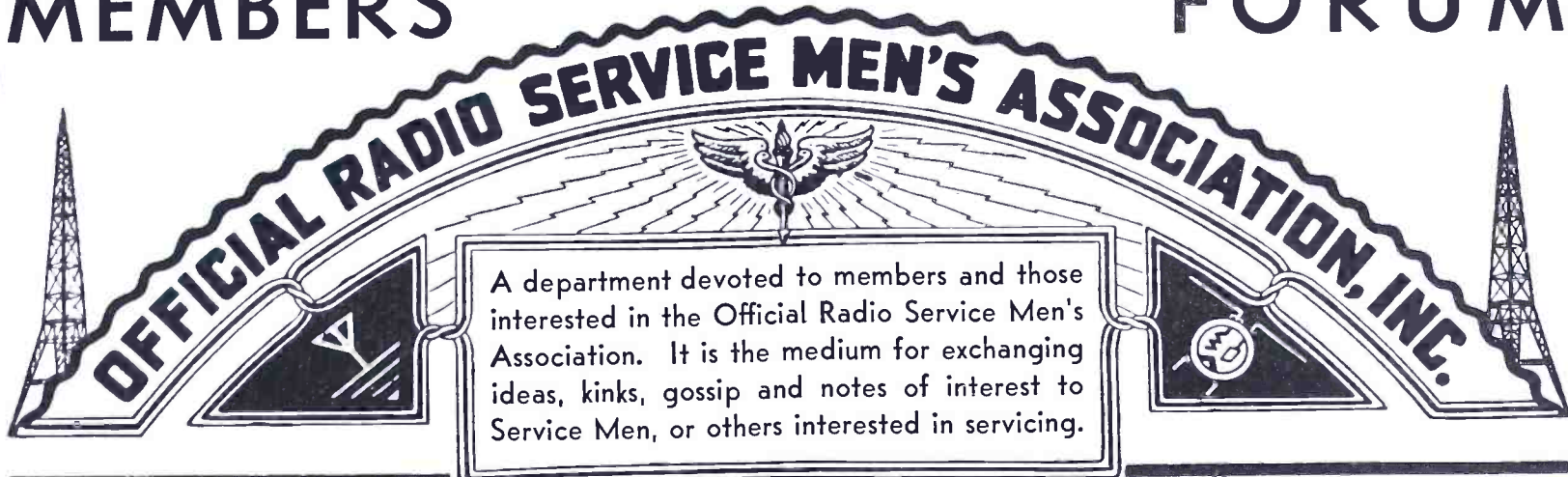

A department devoted to members and those interested in the Official Radio Service Men's Association. It is the medium for exchanging ideas, kinks, gossip and notes of interest to Service Men, or others interested in servicing.

VIBRATOR REPAIRS

RADIO-CRAFT, ORSMA Dept.:

"Don't try to adjust this vibrator yourself."

How many times every day do we, as Service Men, see this on a sticker used to seal up the vibrator in an auto-radio set, or read it in the service manual?

It seems to me that the manufacturers have little confidence in our technical ability to repair their little "buzzer."

In my case, I advertise auto-radio repairing, and vibrators are certainly no exception. I have successfully reconditioned this part of an auto-radio set ever since it made its appearance on the market and find nothing to get all worked up about. If there is anything so complicated about cleaning the points and adjusting a vibrator, I fail to see it after the hundreds of them that I have put back in order again.

What does a customer think when, after fixing everything else about his set, we hesitate about doing anything with the vibrator?

All anyone needs to conduct a successful repair on any and all vibrators is a little common sense, a little confidence, some emery paper and thickness gauges.

Let's hear what other fellows have to say about it.

O. E. PAYNE
Columbus, Ohio

We wonder what the manufacturers have to say about this?

Adjusting auto vibrators in the field is purely a mechanical job and most of the members will agree that there are more Service Men who are straight technicians and poor mechanics than a combination of both. We also have the case of one manufacturer who claims

Installing an "Open Test" in tube checkers

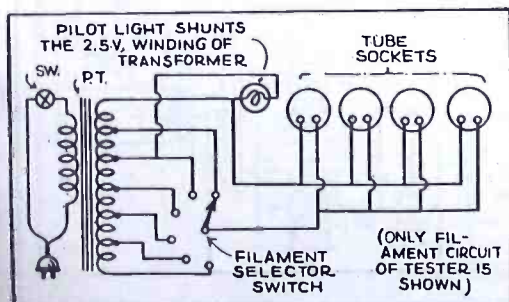

that the only "correct" way to adjust a vibrator is by means of an oscilloscope. See page 730, June RADIO-CRAFT.

SERVICE LICENSES

RADIO-CRAFT, ORSMA Dept.:

Please publish the following in RADIO-CRAFT as a reminder to all radio Service Men, that it will not be long before the "backyard gyp" will be eliminated from the business. This is being accomplished by the "Ordinance to License Radio Technicians" which was adopted by the City Council of Houston, Texas, in Nov. 1934. The ordinance was proposed by the Independent Radio Service Men's Ass'n of Houston, and the Associated Radio Craftsman. This ordinance will be not only a protection to the legitimate Service Man but the public as well. The latter will be protected against defective work.

This Ordinance requires all radio technicians to have a license before engaging in the business of installing and repairing radio sets. A fine ranging from \$10 to \$100 is the penalty for violating this ordinance. Licenses are secured only by taking a written examination before members of the board.

The plan has been in operation 5 months to date and it is operating successfully.

Now, if other cities take up this plan, we will be on our way to clean up the radio service industry.

A REPORTER
Houston, Texas

RADIO-CRAFT is in favor of any legislation that will improve the standing of radio Service Men. The Houston ordinance is now being studied by other cities and in the near future we expect to find it in operation in many major cities.

It is also interesting to note that "A Reporter" and many of his associates in the Houston local organizations mentioned, are members of ORSMA. We hope that Service Men in other cities will band together in the same way. ORSMA will be glad to help in any way possible!

TUBE TESTING IDEA

RADIO-CRAFT, ORSMA Dept.:

Shunting the 2.5 V. tap of any tube

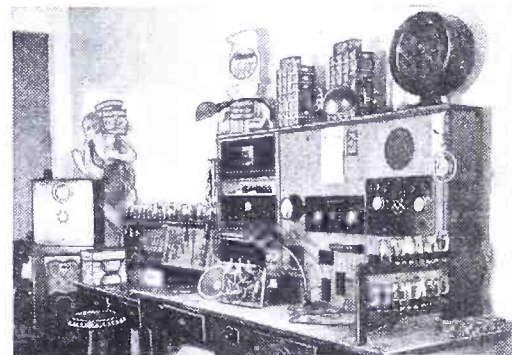

The service bench of L. Babsok (Ozark Radio Lab.)

testing transformer with a pilot light or flashlight bulb will prove an extremely valuable aid to anyone that ever tests radio tubes. The time frequently wasted in waiting for open filament tubes to heat up can thus be eliminated. A schematic circuit of the idea is shown below. In operation the tubes with good filaments will cause a dimming of the pilot light when they are placed in the tester; while those tubes with open filaments will have no effect upon the light.

MEYER TEST
Kansas City, Mo.

A very clever idea Mr. Test. Members of the ORSMA are always pleased to get time saving ideas. This kink is also inexpensive to set up.

PHONO. MOTOR HINT

RADIO-CRAFT, ORSMA Dept.:

The other day I was called upon to service an "Illustravox Junior Amplifier," the turntable of which would start only after turning the switch on and off a number of times. At first appearance it would seem as though the switch was not making contact at all times, but after a thorough check of the switch and the turntable motor the trouble appeared to come from the brushes which would make contact only at intervals. After replacing the brushes, the trouble disappeared.

Another unusual trouble I experienced was on a Chevrolet auto-radio set. On this set stations would only come in from 1,500 to 860 kc. Below this I could only get police and aircraft reports. Upon checking the set, I found a .002-mf. condenser fastened to the "candohm." I replaced this condenser

(Continued on page 119)

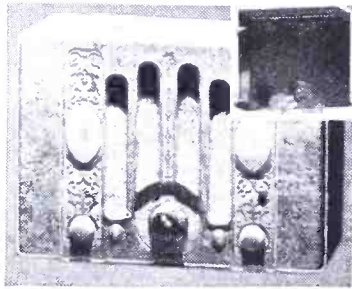

KADETTE MODEL 90 DUPLEX, 4-TUBE 110 V.-6 V. CAR-HOME-FARM SUPER.
 (Current drain, A.C., 17½ W.; battery, 13 W.; 8-tube operation; sensitivity, 10 microvolts-per-meter; has 32-V. adapter—see insert illustration.)

Checking voltages follow (115 V. line):

For car, farm, or home	Tube Type	Cath. Volts	C.-G. Volts	S.-G. Volts	Sup.-G. Volts	Plate Volts
	V1	18	15	110	0	110
	V2	2.7	**	110	2.7	110
	V3**	1	075
	V4*	11	0	115	110

*Rectifier section, Cath. V., 120; Plate, 120, A.C.; ** diode plates—varies.

Align at 600 kc. and 1,500 kc.; bend R.F. plates at 1,000 and 550 kc., if coils are changed (bend oscillator plates only if imperative). Keep green wire on antenna section of 2-gang condenser remote from oscillator; keep antenna coil remote from sockets, and power cord from end of chassis.

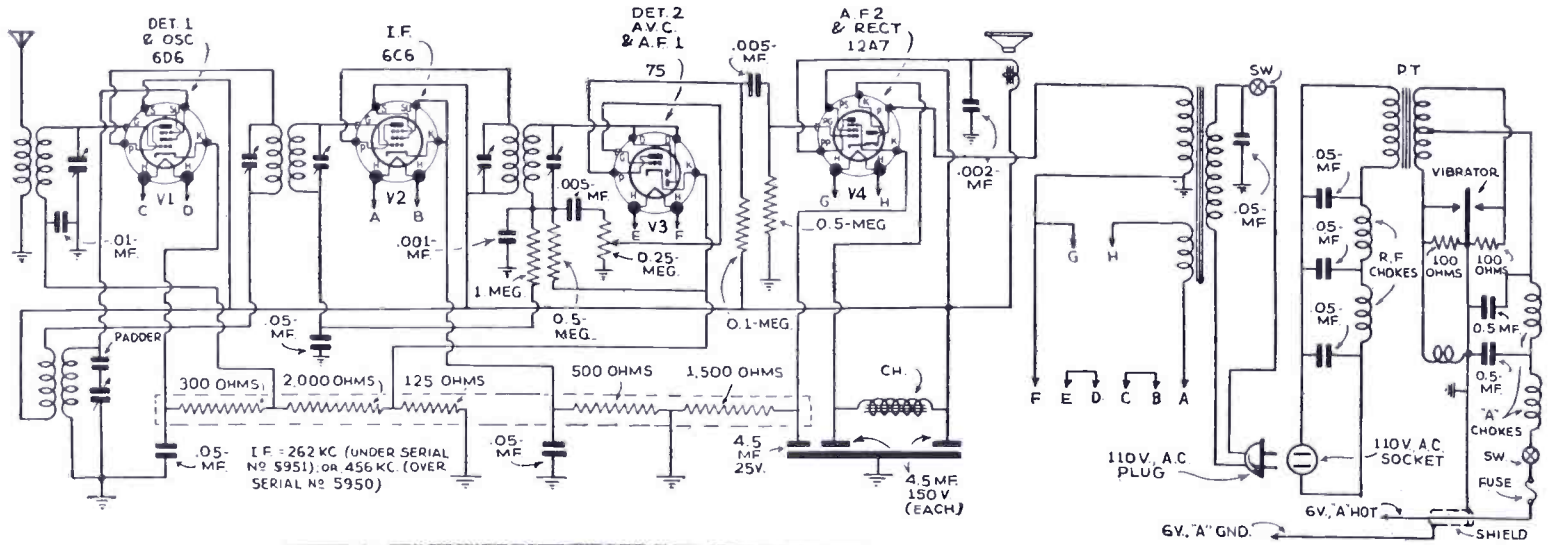

RCA-VICTOR "MAGIC BRAIN" MODEL 281 12-TUBE ALL-WAVE SUPERHET.

(Features: 140 kc. to 36 megacycles; dual A.V.C.; both high and low-tone controls; automatic tone compensation; sensitivity control; anti-resonance cabinet.)

Output of set is 8 W. (undistorted; 16 W., max.) into special 10 in. reproducer. Aligning frequencies in kc.: 175, 410, 460, 600, 1,720, 5,160 and 18,000. Power consumption of set, 130 W.; frequency range in kc. by bands: X—140-410; A—540-1,720; B—1,720-5,400; C—5,400-18,000; D—18,000-36,000. Two A.V.C. units compensate receiving conditions in different bands; high- and low-frequency controls compensate station hum, static, etc. Operating voltage and current figures follow. *Osc. cath., 3 V. and 10.9 ma., Plate 232 V., **768/384, r.m.s. All voltages measured to ground; P.T. connected to 120 V. tap; line, 120 V.; maximum sensitivity; no signal.

Tube Type	Cath. Volts	S.-G. Volts	Plate Volts	Cath. Ma.
V1	2.3	100	231	8.8
V2*	3.0	100	238	10.9
V3	7.0	100	236	3.5
V4	7.0	100	236	3.5
V5	0	60	7.2
V6	11.0	235	5.5
V7	11.0	235	5.5
V8	0	240	365	23.0
V9	0	240	365	23.0
V10	6.0	100	236	4.0
V11	4.7	0	0
V12	**	104.0

RCA
 "De Luxe
 Globe
 Trotter"
 Console

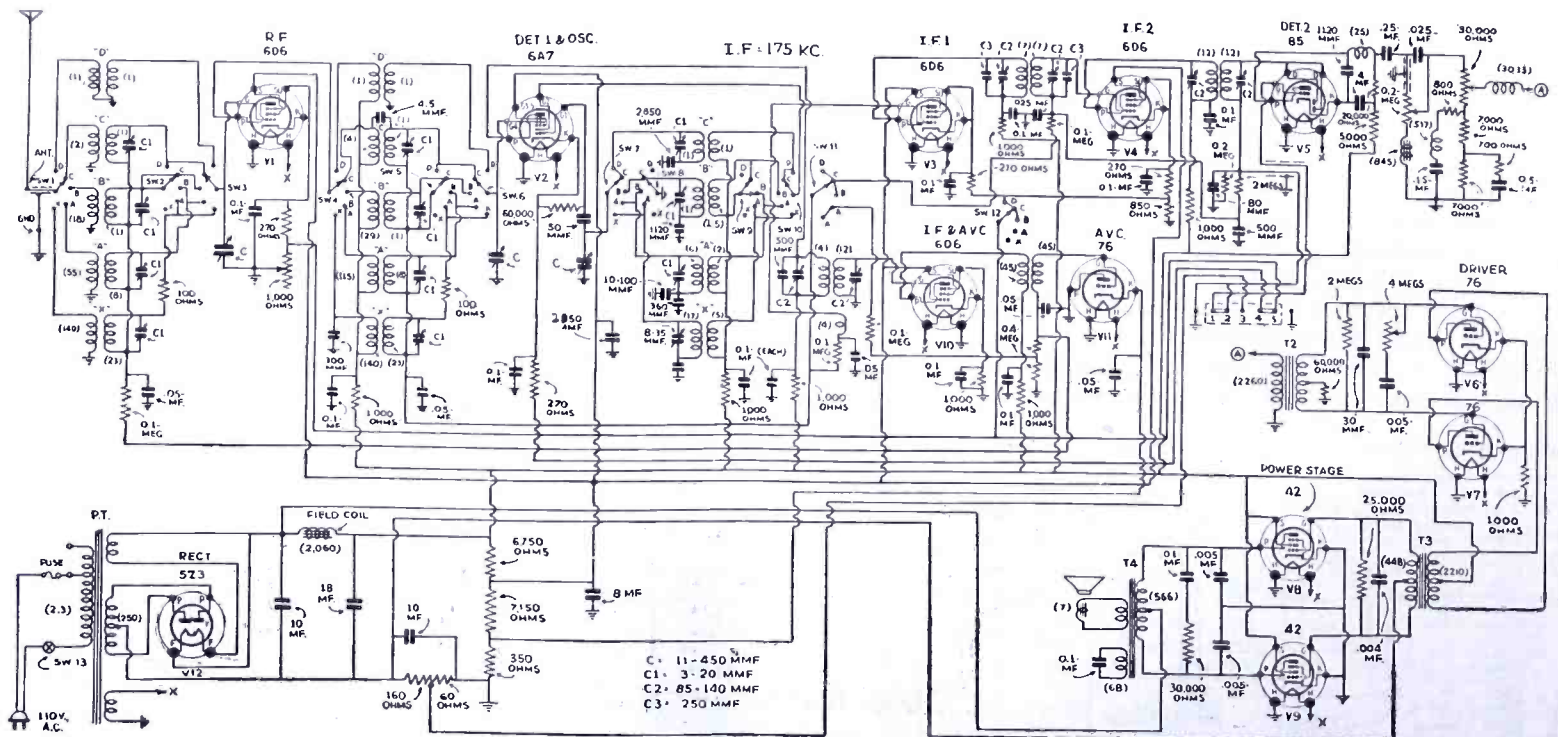
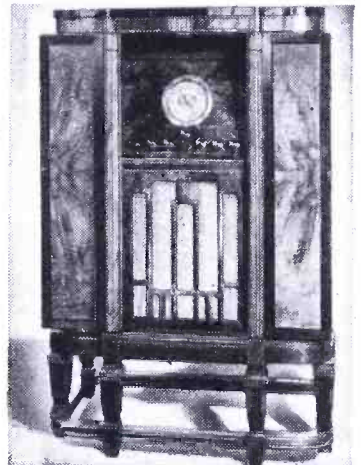

GRUNOW IIA CHASSIS 11-TUBE ALL-WAVE SUPERHETERODYNE

(Features: "Signal Beacon" (beat oscillator), delayed A.V.C.; range, 540-21,500 kc. Output, 45s in class A prime.)

This chassis is made in the following models: 11A, 115 V., 60 cy.; 11AW, 50-60 cy.; 11AX, 25-50 cy.; AZ, 110-135-220-250 V., 50-60 cy. It is used in receiver models 1151 (reproducer model 12A3) and 1152 (reproducer model 10A4).

Circuit oscillation in the driver stage is prevented by means of the 0.1-meg. resistor interposed between the grids of the two driver 76s. The undistorted power output of the amplifier is approximately 9 W.

The short-wave section of the receiver consists of 3 tuned circuits.

The "signal beacon" or beat oscillator featured in this receiver is used as a means of locating the carriers of weak, distant stations, by producing the characteristic heterodyne whistle when nearly in resonance with the desired carrier, and no signal or "zero beat" when exactly in tune. It is also used for the reception of continuous-wave code signals. The plate voltage on the separate 76 used as the beat oscillator is applied by closing the switch which is ganged with the tone control. Frequency ranges follow: D—550-1,500 kc.; C—1,500-4,200 kc.; B—4,100-10,000 kc.; A—

8,500-21,500 kc.

Alignment frequencies in kc. are as follows: 262, 600, 1,400, 3,700, 10,000 and 20,000. The output meter should be capable of good deflection over wide ranges of signal strength. High-frequency disturbances will cause difficulties when the short-wave section is being adjusted; use of a screen room is recommended. For I.F. alignment, connect service oscillator to first-detector grid through .25-mf.; for R.F., at 3,700 kc. to Ant. post, through 200 mmf.; for 10,000 kc., to Ant. post, through 400 ohms (return to chassis).

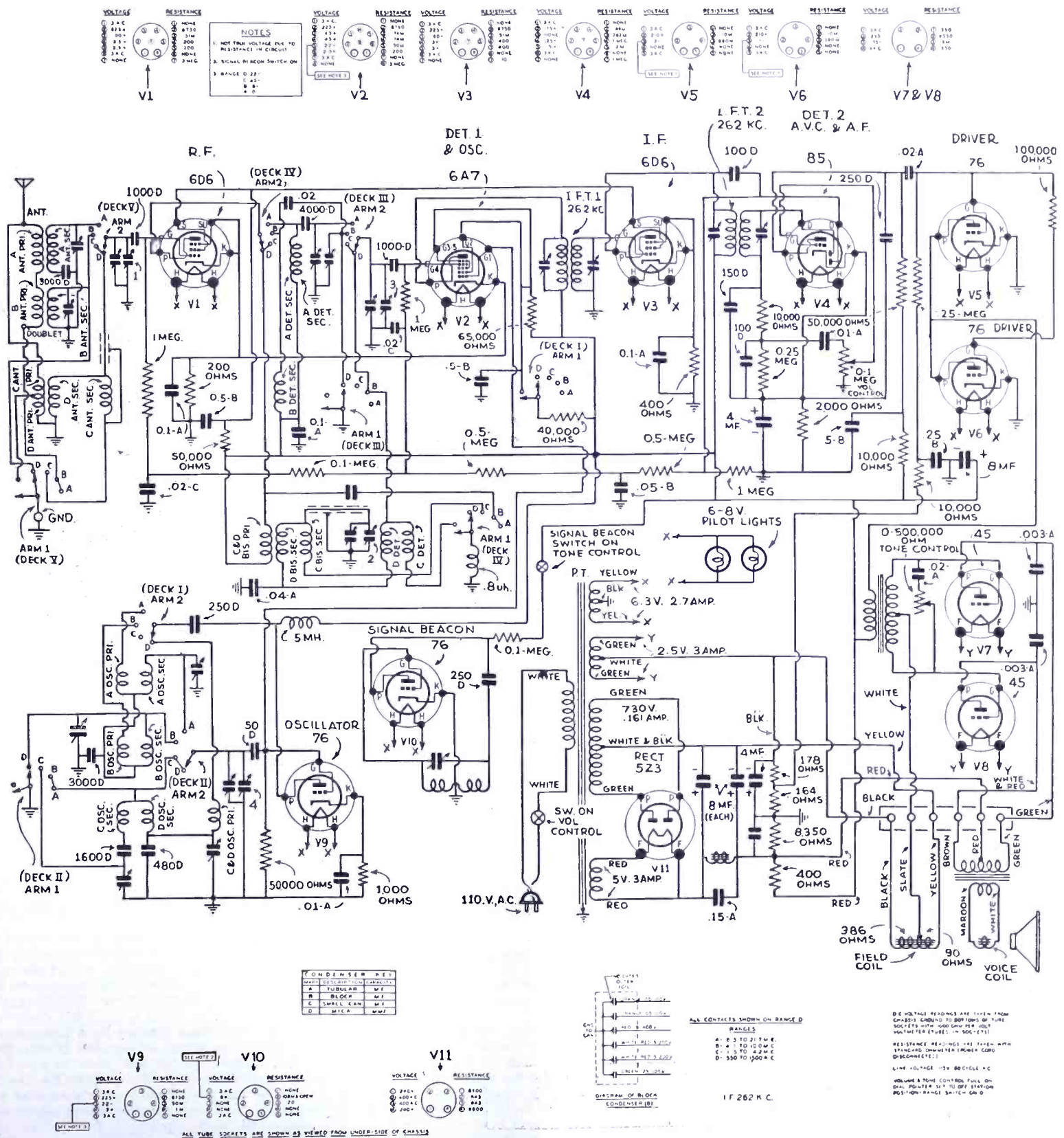

CONDENSER SET	
A	TUBULAR M.F.
B	BLOCK M.F.
C	SMALL CAN M.F.
D	MICA M.F.

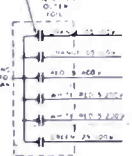

ALL CONTACTS SHOWN ON RANGE D
RANGES:
A: 5 TO 21 MC
B: 4 TO 10 MC
C: 1.5 TO 3.2 MC
D: 550 TO 1500 KC

DC VOLTAGE READINGS ARE TAKEN FROM CHASSIS GROUND TO BOTH SIDES OF TUBE SOCKETS WITH 1000 OHM PER DIV. VOLTMETER (TYPE 1150-1151)
RESISTANCE READINGS ARE TAKEN WITH TRIMMABLE CHASSIS METER (MODEL 1000) DISCONNECTED.
LINE VOLTAGE 115 VOLTS AC
VOLUME & TONE CONTROL FULL ON ORAL POWER 115 TO 110 OFF STATION POSITION RANGE SWITCH GND

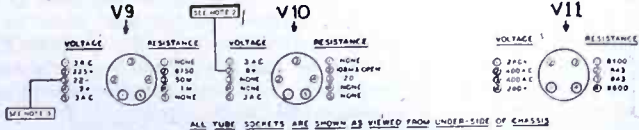

Brand New!



—a home study
help to
advancement
in radio

New book prepares you to pass examinations for all classes of radio operator licenses. Will help experienced operator or station technician to advance to better job. Equally suited for man just entering this field. Planned especially for home study.

Just published

PRACTICAL RADIO COMMUNICATION

By Nilson and Hornung, well-known radio experts, instructors, writers. Covers radio principles, radio equipment and power apparatus as applied to broadcasting, marine, police, aeronautical and amateur radio. Includes entire spectrum of radio wave lengths, from ultra-short to long-wave. Chapters on tubes, circuits, control-room operation, transmitters, radio aids to navigation, etc. Complete, practical, authoritative. New features of arrangement. 744 pages, nearly 500 illustrations, \$5.00. Use this book to get ahead in radio operating.

Examine book on approval; send this coupon

M:GRAW-HILL BOOK CO., INC.,
330 W. 42nd St., N. Y. C.

Send me Nilson and Hornung's Practical Radio Communication for 10 days' examination on approval. In 10 days I will send \$5.00, plus few cents postage, or return book postpaid. (Postage paid on orders accompanied by remittance.)

Name

Address

City and State

Position

Company RC-8-35
(Books sent on approval in U. S. and Canada only.)

PRESENTING THE MULTIPLE-IMAGE TELEVISION RECEIVER

(Continued from page 74)

first time) and that is, multiple image television, must be adopted when television finally arrives commercially.

In the illustrations on this page I have shown a number of ways in which the problem is readily accomplished. A three-way multiple screen upon which the same program is seen simultaneously, might be termed ideal for home purposes. There is, however, no good reason why the future television receiver cannot be built with four or six screens so that when the receiver is placed in the center of a large room everyone can view the screen with ease, no matter where he is located in the room.

From the technical angle, there are a number of solutions in order to solve multiple image television. The easiest, of course, would be to have three units, each unit throwing its image on one screen. By this I mean that if you were to build the television receiver, you would then use, let us say, three cathode-ray tubes, all arranged in such a manner that they would work in parallel, each unit throwing the identical image on its individual screen. This, of course, with the present cathode-ray tube would be expensive. Perhaps a multiple-element tube, having three sets of elements in one glass envelope, as illustrated would be a commercial compromise with this cost problem.

If we had a sufficiently powerful cathode-ray tube, on the other hand, a single tube could be used and by use of mirrors or prisms, the one image could be thrown simultaneously upon three separate screens. Of course, in this way we also would have some losses in light intensity because in dividing the light into three channels we naturally would lose in the process thereby; but if, in the future, new means are invented to give a surplus of light intensity, there is no reason then why a single tube could not be used.

As I have mentioned in my articles on television in the past, I do not believe that either the rotating mechanical disc or for that matter the cathode-ray tube will be the final word in television. Rather, I foresee some other means whereby with an electronic device (which is not necessarily a cathode-ray tube, and which device can be quite small and inexpensive), a powerful image could be thrown on a screen without any so-called scanning device such as we make use of today. In this case we would have three of these inexpensive units, all connected in parallel, each of these three "electronic scanners" would project an image simultaneously upon individual screens, as illustrated.

There is still another method which I can picture in my mind, and in which the television screen itself also is its own televisor. The screen would be constructed of several layers of glass or transparent material and would be electronically operated. It would, in other words duplicate the structure of the animal eye. We have reasons to believe today that seeing in our eyes is accomplished by *electro-chemical* means. The eye, moreover, does not "scan" as television men understand the term. It should be possible to duplicate the function of the eye *directly* from a special electro-chemical or *electron-chemically* operated screen. The exact solution for this has, as yet, not been found. I believe, however, that we are getting nearer to it all the time, and when it does come multiple television images will be the accepted procedure.

TELEVISION—PRESENT AND FUTURE—DeFOREST

(Continued from page 75)

made, without rotating parts and possessing infinite endurance, which I believe is capable of solving the problem of an acceptably fine, brilliantly illuminated, reasonably large screen picture in the home.

"I look to see this system actually introduced within the next 12 or 18 months. Its introduction will parallel in a degree that of the introduction of radio broadcasting, gradually from a few centers, finding and paying its way as it goes, without the lavish financial program, calling for the fantastic figures in scores of millions of dollars, concerning which we have read so much in the newspapers in the past year."

"FREQUENCY" VS. "AMPLITUDE" MODULATION

(Continued from page 75)

of noise reduction which can be obtained depends on the strength of the noise. One of the worst disturbances encountered on short wavelengths are the noises due to the motion of the electrons in the circuits and in the tubes of the radio receiving set itself. (See "The Limit of Amplification," in the preceding July issue.—Ed.) On the New York-Haddonfield circuit the energy of this disturbance is reduced to one one-thousandth part without losing any of the signal strength. As the strength of the disturbance increases, the ratio of the improvement becomes less.

The effect is something like that of the "tin hat" worn overseas in the AEF—practically perfect against fragments up to a certain size, but not effective against a six-inch shell.

The practical utility of the system will be principally on the ultra-short and micro-wave signalling systems, as the bands of frequency or width of the channel required is greater than on normal broadcast wavelengths.

For example, the band width at present used on the Empire State—Haddonfield set-up is about 150,000 cycles. This would not be a practical band width to use on present-day broadcast channels, but it is quite feasible on the 40,000,000 cycle wave used at the Empire State. The range of modulation frequencies which can be transmitted from the best transmission systems today does not extend beyond 8,000 cycles, and only frequencies up to about 5,000 cycles can be effectively used without encountering interference from adjacent channels.

On account of the extremely short wavelengths it has been possible to transmit all modulation frequencies from thirty to 16,000 cycles, and to receive them with what engineers call a flat characteristic.

The theory on which the problem was solved flies directly in the face of all previous mathematical deductions. The old theory of the way to shut out static assumed that the best that could be done was to narrow the band of the selective systems at the receiver as much as possible without shutting out the signal. By narrowing the band down to a width just sufficient to admit the signal, it was believed that under these conditions the signal-to-static ratio would be the best.

Where the signals and disturbances are of the same order of magnitude, I find the exact opposite to be true. With proper methods of transmission and reception, the wider the band, the better will be the signal-to-noise ratio.

(This completes all the information that can be obtained at this time from Major Armstrong or Columbia University where the Major is a Professor of electrical engineering. However, *Radio-Craft* has in preparation some very interesting data concerning modulation in its various forms—especially *frequency* modulation which is the basis of the Armstrong system. This information will appear in a forthcoming issue.—Ed.

RCA INSTITUTES ANNOUNCES NEW COURSE

The School of Communication Engineering of RCA Institutes announces the addition of two courses in communications subjects to the Evening School Curriculum.

The courses, two in number, each have 60 hours of lectures and 48 hours of laboratory work. The first, Vacuum Tubes, is devoted to the subject which its name implies and covers application of the vacuum tube as an amplifier, detector and oscillator.

Circuit Elements is the title of the second of the courses. This unit is the study of the behavior of inductance, capacity and resistance, individually and in various combinations, at the frequencies commonly encountered in communications work.

While both of these courses have been taught for the last three terms in the Day School, they are being offered for the first time in the Evening School beginning with the 1935 Fall Term.

It will be the first time in the history of the school that real day engineering subjects will be taught to night students. Technicians and Service Men who can spare the time will find real help from these subjects.

AMPERITE LEADS AGAIN!

High Impedance Velocity Microphone
(Model RB-H)
Operates **WITHOUT PRE-AMP**

A HIGH IMPEDANCE VELOCITY MICROPHONE WHICH OPERATES DIRECTLY INTO GRID OF TUBE

REQUIRES NO PRE-AMPLIFIER WHEN USED WITH REGULAR HIGH GAIN AMPLIFIER (100 DB.)

Replaces condenser and crystal microphones—NO CHANGES or additions necessary! ELIMINATES INPUT TRANSFORMER and its losses. Therefore requires 12 db. less over-all amplification. Eliminates inductive hum. No feedback. Life-like, natural reproduction. Write for Bulletin H.

LIST \$42.00 with coupling.

AMPERITE Corporation 561 BROADWAY NEW YORK

AMPERITE 7 POINT VELOCITY **MICROPHONE**

If you are interested in reading the finest scientific-constructional-technical magazine in the field, then turn to page 112 of this issue. You will find an announcement about EVERYDAY SCIENCE AND MECHANICS.

Please Say That You Saw It in RADIO-CRAFT

SOME FACTS ABOUT THE FARNSWORTH SYSTEM

(Continued from page 82)

high-voltage transformer is also quite small, and standard types of receiving set condensers are connected in series for filtering.

The cathode-ray tube is a Farnsworth "Oscillight" with a 9 in. screen, which produces an image 5 x 6 ins. The image is black and white and bright enough to be viewed in a partially lighted room.

Figure 1 shows the details of this tube. In place of the receiving aperture there is an "electron gun" which sends an intense beam of high velocity electrons down the axis of the tube. This beam is focused (by means of a magnetic field) on the fluorescent screen where it produces a bright spot of light. A special electrode, whose action is similar to that of the grid in a three-element vacuum tube, is connected to the input signal pulses and serves to control the intensity of the electron beam, and consequently the brightness of the fluorescent spot, keeping this brightness proportional to the light intensity of the spot on the image being scanned at that particular instant. A pair of magnetic deflection coils (whose action is analogous to the corresponding pair on the image dissector, which is used in the transmitter) is fed with a current of the same frequency and wave-form as that feeding the latter, and serves to displace the cathode-ray spot on the fluorescent screen, causing it to trace out a line of the image. The low or image frequency magnetic deflecting field of the oscillight differs from that in the dissector in that an iron-core electromagnet is used, but its action is essentially the same, since it displaces the cathode-ray beam at right angles to the lines at a uniform rate, such that successive lines are displaced by the width of the spot from the preceding line. Thus at any instant the position of the spot on the fluorescent screen of the oscillight corresponds exactly to the position of the scanning aperture on the electron image in the image dissector tube, and the brightness of the spot corresponds to the brightness of the corresponding point on the optical image.

Since the saw-tooth generators of image dissector and the oscillight are separate electrical units, it is necessary to provide some means of exactly synchronizing them. This is accomplished by means of synchronizing impulses which are sent along with the signal impulses. The line frequency generator feeding the image dissector is coupled to the output circuit of the image dissector in such a manner that it delivers a large impulse into this circuit during the back trace of the scanning line. At the receiving end this impulse comes through with the signal impulses and is amplified along with them. By means of a tuned selective filter circuit this synchronizing impulse is separated from the television impulses and after additional amplification is fed into the line frequency saw-tooth generator which feeds the oscillight deflecting coils. If this added impulse amounts to several per cent of the impulse produced by the generator it is sufficient to "lock" the line frequency generator of the receiver firmly in step with the corresponding generator at the transmitter. Since the "back trace" of the scanning line is not instantaneous it is desirable to extinguish the cathode ray during this back trace so that it does not appear on the fluorescent screen. This is done by means of coupling the line frequency generator to the modulator electrode of the oscillight in such a way that a large negative potential is applied to this electrode during the back trace, thus extinguishing the cathode-ray beam during this interval.

RAYTHEON OFFERS "METAL" TUBES

The Raytheon Production Corporation, makers of the "4-pillar" tubes, has recently announced that they are now manufacturing the new metal-type tubes. Mr. D. T. Schultz, vice-president states, "We will be glad to fill orders in reasonable quantities for experimental purposes at \$1.00 per tube to experimental laboratories and manufacturers." It will be some time before these revolutionary tubes will reach the hands of the consumer, therefore, it will not be necessary for the Service Man and Dealer to make any investment at this time. Complete details of the tubes are given in the preceding June issue of *Radio-Craft*, page 736.

I defy the static. And any other interfering noises. Let 'em all come—whirrs, buzzes, screeches, man-made or other noises—anything that chafes your eardrums—I'll keep them out of your set!

PERFECT EUROPEAN RECEPTION!

Muter has met your doublet antenna problem—and solved it—with this new tuning device. It will couple a double antenna to your set—or any set—and it has switch control! This adapts it to all wave-lengths by a mere turn of the switch. The three taps adjust the antenna for QUIET European reception, efficient broadcast reception, or the sharpest possible tuning on any band. Think of the convenience! No need to disconnect wires. Just turn the switch. Any antenna but a doublet is obsolete—and any doublet without "Little Ajax" is just another aerial! With this coupler, your set will develop new tonal excellence and a quickened responsiveness. In addition to an unheard of fidelity and resonance, you will find your set increasing in efficiency and volume. More important than the improved reception, this coupler resists outside and man-made interference! It reduces static to an *absolute minimum*.

Get one from your jobber—or mail the coupon NOW and this All-Wave Tuning Coupler will be sent to you at once; either pin a dollar to the coupon or just pay the postman \$1.00 plus postal C.O.D. charges when it arrives. And, of course, it takes out all your reception troubles or your money will be immediately refunded.

Complete instructions for making the perfect doublet antenna system and attaching this coupler are included.



THE MUTER COMPANY
1255F So. Michigan Ave.
CHICAGO, ILLINOIS

MAIL THIS COUPON!

THE MUTER COMPANY
1255F South Michigan Ave.
Chicago, Illinois

Please RUSH me one of your All-Wave Tuning Couplers.

- I am enclosing \$1.00.
- I will pay the postman \$1.06 to cover all charges. (It must satisfy me in every way.)

Name

Address

City State

To Readers of RADIO-CRAFT FREE POST CARDS MAY BE HAD UPON WRITING TO PUBLISHERS

● These postcards make it easy for you to answer any of the advertisements which appear in RADIO-CRAFT, and without cutting any valuable articles or data which you may wish to save.

Many times manufacturers request you to "clip the coupon" when answering their ads. Often this means destroying part of an article on the reverse page you may need later for reference. Save your RADIO-CRAFT issues complete. If you should ever want to see bound volumes, or certain copies of RADIO-CRAFT, the resale value of *uncut* issues is very much higher than that of mutilated ones. Furthermore, some numbers are already out of print, and the earlier ones cost 50 cents apiece. So send for a supply of these free post cards and use them in answering all RADIO-CRAFT advertisers.

INSIST UPON



PRECISION TESTERS AND INSTRUMENTS ... FOR GREATER ACCURACY, DURABILITY AND SPEED!

Present Triplet models check all circuits and test the new metal Octal tubes. Instruments now in use can easily be adapted to fit all new requirements.

SEE YOUR JOBBER

WRITE FOR TRIPLET CATALOG

Triplet Electrical Instrument Co.
162 Main St. Bluffton, Ohio

HANDY *Electric* PAINT SPRAYER

ONLY \$14.50

Complete Outfit and Spray Gun

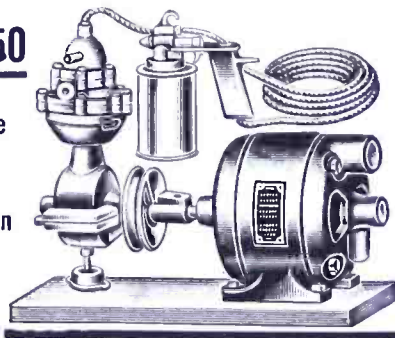

Startling offer! Famous spraying outfit includes pressure internal mix spray gun, adjustable, non-clogging, fan and round spray nozzles. Ideal for spraying paint, varnish, enamel, lacquer, shoe dyes, aluminum paints, insecticides, etc. The power way saves time and labor and does better work. Outfit complete with spray gun, National Compressor with sealed piston (cannot pump oil), heavy duty Westinghouse motor, 110 volt, 60 cycle, A.C., plug and cord, safety valve, 15 ft. air hose. Just plug into light socket and it is ready for operation. **\$14.50 complete.** Send \$5.00 deposit, balance C. O. D. Shipping weight, 30 lbs. **Sold on money-back guarantee basis.**

Do not write for Catalog.

WELLWORTH TRADING COMPANY
560 W. Washington Blvd. Chicago, Ill.

WELLWORTH TRADING COMPANY
500 W. Washington Blvd., Chicago, Ill. RC-835

Enclosed you will find my remittance of \$14.50, for which please send me

- Electric Paint Sprayer, by Express collect.
- Or \$5.00 deposit, with balance C. O. D.

Name.....

Address.....

City..... State.....

TECHNICIANS' DATA SERVICE

JOSEPH CALCATERRA DIRECTOR

The literature listed in this department contains a wealth of very useful information.

A special arrangement between RADIO-CRAFT magazine and the publishers of this literature, which permits bulk mailings to interested RADIO-CRAFT readers, eliminates the trouble and expense of writing to each individual organization represented in this department.

2. HAMMARLUND 1935 CATALOG. Contains 12 pages of specifications, illustrations and prices on the new line of Hammarlund variable, mid-get, band-spread and adjustable condensers; trimming and padding condensers; R.F. and I.F. transformers, coils and coil forms; sockets, shields, chokes and miscellaneous parts for ultra-short-wave, short-wave and broadcast operation.

3. HOW TO GET A HAMMARLUND 1935 SHORT-WAVE MANUAL. A circular containing a list of contents and description of the new 16-page Hammarlund Short-Wave Manual, which contains construction details, wiring diagrams, and list of parts of 12 of the most popular short-wave receivers of the year.

4. THE "COMET PRO" SHORT-WAVE SUPERHETERODYNES. Describes the outstanding features of the standard and crystal-type Hammarlund "Comet Pro" short-wave superheterodynes designed to meet the exacting demands of professional operators and advanced amateurs for a 15 to 250 meter code and phone receiver, but which can be adapted by anyone for laboratory, newspaper, police, airport and steamship use.

5. ELECTRAD 1935 VOLUME CONTROL AND RESISTOR CATALOG. Contains 12 pages of data on Electrad standard and replacement volume controls. Truvolt adjustable resistors, vitreous wire-wound fixed and adjustable resistors and voltage dividers, precision wire-wound non inductive resistors, center-tapped filament resistors, high-quality attenuators, power (50- and 150-watt) rheostats and other Electrad resistor specialties.

25. LYNCH NOISE-REDUCING ANTENNA SYSTEMS. Complete descriptions and instructions issued by Arthur H. Lynch, Inc., for making all kinds of antennas for broadcast and short-wave reception, with a special supplement covering Ham Antenna Design for transmitting as well as receiving all the amateur bands, including the ultra-high frequencies.

26. LYNCH AUTO RADIO ANTENNAS, FILTERS AND NOISE SUPPRESSORS. This folder describes a complete line of Lynch antennas, filters and ignition noise suppressors designed for auto radio installations. The antenna system is of the under-the-car type for easy installation. It includes data on Hi-Gain matched-impedance transmission lines which make the under-car antenna highly desirable for use with the new "Turret-top" cars.

28. LYNCH SUPER-FILTASTATS FOR AUTO RADIO INSTALLATIONS. Describes and illustrates, with instructions for using, the new Lynch Super-Filtastats which do away with the need for suppressors in auto-radio installations, giving better performance in operation for both the car and radio set.

34. SERVICE MAN'S 1935 ELECTRAD REPLACEMENT VOLUME CONTROL GUIDE. A 52-page vest-pocket size booklet containing a revised, enlarged and complete list, in alphabetical order, of all old and new receivers showing model number, value of control in ohms and a recommended Electrad control for replacement purposes. Contains specifications and volume-control circuits for over 2,000 receiver models.

57. RIBBON MICROPHONES AND HOW TO USE THEM. Describes the principles and operating characteristics of the Amperite velocity microphones. Also gives a diagram of an excellent humless A.C. and battery-operated preamplifier.

62. SPRAYBERRY VOLTAGE TABLES. A folder and sample pages giving details of a new 300-page book, containing 1,500 "Voltage Tables" covering receivers manufactured from 1927 to date, published by Frank L. Sprayberry to simplify radio servicing.

64. SUPREME No. 385 AUTOMATIC TESTER. A technical bulletin giving details, circuits and features covering this new Supreme development designed to simplify radio servicing. In addition to the popular features of Supreme analyzers and tube testers it contains many direct-reading features which eliminate guesswork or necessity of referring to charts or tables.

67. PRACTICAL MECHANICS OF RADIO SERVICE. Information, including cost, features and outline of lessons of the Frank L. Sprayberry course in Radio Servicing, and list of Sprayberry Data Sheets for modernizing old radio equipment.

72. HALLICRAFTERS' SKYRIDER SHORT-WAVE RECEIVERS. Description of the Sky rider tuned R.F. and Super Sky rider superheterodyne short-wave receivers designed and built by Hallicrafters, Inc. Features: range of 13 to 200 meters (with broadcast or 10-meter band optional), automatic wave-change switch, continuous band-spread, built-in monitor, speaker and power supply (or batteries), high-fidelity audio, and other refinements.

73. HETRO HOME & AUTO-RADIO RECEIVERS AND ACCESSORIES. A folder containing descriptions, illustrations, list and net prices of the Hetro Electrical Industries, line of console, phono-radio and table-model home radio receivers, auto-radio sets, phonograph automatic record changers and motors, antenna systems and D.C. converters.

74. SPRAGUE 1935 ELECTROLYTIC AND PAPER CONDENSER CATALOG. Gives specifications, with list and net prices on a complete line of wet and dry electrolytic, and paper condensers made by the Sprague Products Co. for radio Service Men, set builders, experimenters and engineers. Information on the Sprague Capacity Indicator, for making capacity tests on condensers and in servicing receivers, is included.

75. SPRAGUE TEL-U-HOW CONDENSER GUIDE. A valuable chart, compiled by the Sprague Products Co. which tells the proper types, capacity

(Continued from page 108)

Radio-Craft Technicians' Data Service

99 Hudson Street,
New York City, N.Y. RC-835

Please send to me, without charge or obligation, the catalog, booklets, etc. the numbers of which I have circled below.

2	3	4	5	25	26	28
34	57	62	64	67	72	73
74	75	76				

My radio connection is checked below:

- Service Man operating own business.
- Service Man for manufacturer.
- Service Man for jobber.
- Service Man for dealer.
- Service Man for servicing company.
- Dealer.
- Jobber.
- Experimenter.
- Professional Set Builder.
- Amateur Set Builder.
- Licensed Amateur.
- Station Operator.
- Radio Engineer.
- Laboratory Technician.
- Public Address Worker.
- Manufacturer's Executive.
- Student.
-

I am a:

- Subscriber Newsstand reader

I buy approximately.....of radio material a month. (Please answer without exaggeration or not at all.)

Name

Address

City..... State.....

(Please print name and address)

Avoid delay. The catalogs and booklets listed are now in stock and will be sent promptly as long as the supply lasts.

Please Say You Saw It in RADIO-CRAFT

RADIO'S CRAFT'S "IDEAL RADIO SERVICE SHOP" CONTEST

(Continued from page 83)

produce instruments which you need and which will fill your exacting needs more closely.

So it turns out to be a merry "ring around a rosey"—you win these new service instruments and give the manufacturers hints on how to make new instruments to help you, etc.

But don't delay. NOW is the time to get all your best ideas lined up so that you can be one of the fortunate winners. Jot down any ideas you get in the next few days. And then use all these ideas in writing your letter. Literary ability doesn't count—neither does penmanship—it is the facts and ideas that you include in your letter which will be the important factors in judging whether you win or not! So get busy! This is the last opportunity we will have to remind you about it—we'll have to depend upon you, from now on, to tell your friends about this contest and the closing date. (Here's a grand chance for a club to win a valuable test instrument that all the members can use.)

(NOTE—The Supreme Instruments Corp. which is donating the fourth prize—the deluxe analyzer—or optionally, the tube tester—has informed us that the instrument they will supply will be a new, improved model which has provision for testing the metal tubes; also, a built-in power pack increases the resistance-test range to 20 megs.—the list price, however, remaining the same.)

RULES OF THE CONTEST

- (1) Simply write a letter of 300 words (or less) on the subject: "My Ideal Radio Service Shop."
- (2) The contest is open to all readers of *Radio-Craft* (excepting the employees of the publishers and their relatives).
- (3) You need not own a service shop nor possess any of the equipment you describe.
- (4) No detailed technical description of the apparatus is required or desired, nor the names of the manufacturers.
- (5) Mention of elaborate testing equipment suitable only for exhibition use will detract from the value of the letter. The inclusion of useful, confidence-creating apparatus, however, is recommended.
- (6) Literary ability is not required. Anyone writing in understandable English, giving a good word description, has an equal opportunity of winning one of the prizes.
- (7) Write only on one side; sign your name and address CLEARLY in the upper-right-hand corner; and number each sheet.
- (8) This contest began on June 1, and will continue for 2½ months, closing on August 15. All contest letters must be post-marked not later than midnight, August 15, 1935.
- (9) *Radio-Craft* reserves all rights to the use of the letters submitted to this contest.
- (10) Announcement of the first 25 letters eligible for the prizes will appear in the September, 1935, issue of *Radio-Craft* (If your name does not appear in this list, try again); announcement of the second batch of 25 "eligibles" will appear in the following October number; and announcement of the Awards to prize-winning contestants among these 50, and those who have made subsequent entries, will appear in the November, 1935, issue of *RADIO-CRAFT*. Awards will be shipped to the winners within 10 days after publication of the names. (Deliveries will be made either from *Radio-Craft* offices, or directly from the manufacturer.)
- (11) To each of six contestant on the subscription records of *Radio-Craft* by August 15, 1935, whose letters are adjudged best, will be awarded a volume of the 1,000-page *Official Radio Service Manual*. This special award is an additional prize that does not have any effect on eligibility for a main prize. (In other words, it is possible to receive both a *Consolidated Manual* and a service instrument.)
- (12) Mail all contest letters to:
Contest Director, "My Ideal Service Shop,"
RADIO-CRAFT,
99 Hudson Street,
New York, N.Y.

CATHODE-RAY APPLICATIONS IN TELEVISION

(Continued from page 81)

given spot. In the past and with other types of cathode-ray tubes the operator must use care in keeping the stream moving at all times.

In summing up the advantages of a cathode-ray television receiver over other types, the most important is the ease with which it can be synchronized when the transmitter and receiver are on different power systems. The mechanical television receiver, because of its moving parts which have considerable inertia, requires no little amount of power to lock it in step, while the cathode-ray receiver, because of the fact that the only moving part is a beam of electrons, requires no power to maintain synchronism. Another very important advantage is the ability of the cathode-ray receiver to be shifted from a system using, say, 60 lines per frame to one using 120 lines per frame, so as the art progresses the set does not become useless.

Other advantages of a "teletube" are noiseless operation, less weight in the set, less flicker in the picture and more natural color. It also lends itself more readily to the development of color television images.

COLOR TELEVISION WITH CATHODE-RAY TUBES!

Color television can be accomplished by one of several processes now available to the laboratory worker.

The salts which respond to the various colors can be applied in layers across the screen or the screen can be divided into sections and three primary colors applied in each section. This is somewhat like the off-set color process of printing but it occurs so fast that the eye receives the effect of a blend of color. However, this development is a long way off because it is difficult to forecast whether the public will take to color television images. In the motion picture industry, the public demanded black and white pictures over color, although there are some excellent color movie processes.

It is my understanding that as this issue of *Radio-Craft* goes to press that the first full-length motion picture in color will be made by Technicolor for early release. My attention has also been called to the fact that an inventor in Belgium has also discovered color television along the lines described above.

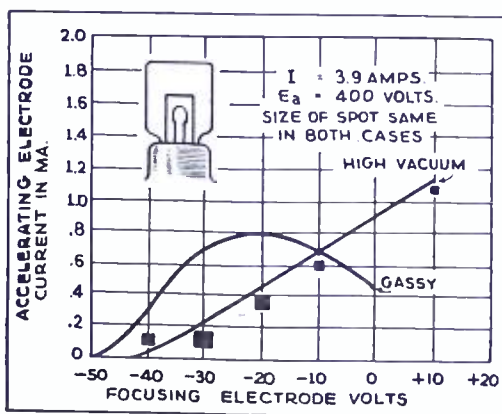
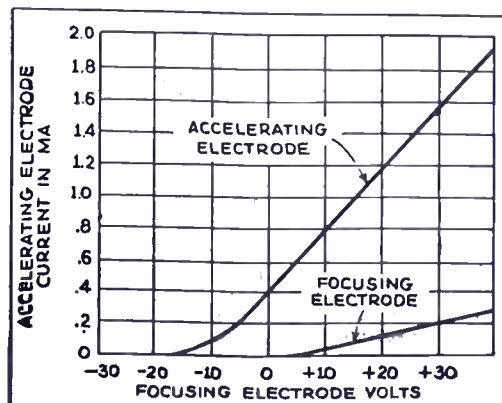

Fig. 1, above, A comparative curve for high-vacuum and gas-filled tubes. Fig. 2, below, Characteristics for a typical tube



Please Say That You Saw It in *RADIO-CRAFT*

"I DON'T CLIP MANY COUPONS"



... but I'm sure glad I sent for this book."

Maybe you're not in the habit of sending for advertised booklets, either . . . but the man who wrote us this letter . . . and 35,000 other radio men who have clipped this coupon . . . know that this booklet is really worth sending for . . . that it actually puts money in their pockets!

Here's why it puts money in your pocket . . . it contains descriptions of every type of radio tube . . . with circuit applications of each one. And besides that, it includes diagrams that show actual problems that other service men have come up against . . . and the easiest way to solve these problems. It's a gold mine of information. Don't put off sending for this booklet. It's crammed with information that will iron out a lot of your troubles. Just send 10c in stamps, and you'll get the book in a few days.

HYGRADE SYLVANIA CORPORATION
Makers of SYLVANIA TUBES, HYGRADE LAMPS
Factories at Emporium, Pa., Salem, Mass. and St. Mary's, Pa.
© Hygrade Sylvania Corp., 1935

Sylvania
THE SET-TESTED RADIO TUBE

10c—TECHNICAL MANUAL—10c

Hygrade Sylvania Corporation
Emporium, Pennsylvania. (RC-8)

Please send me the new Sylvania Technical Manual.
I enclose 10 cents in stamps.

NAME

ADDRESS

CITY STATE

EXPERIENCED MEN Get the Big Radio Jobs

S. Q. NOEL
PRES. FIRST NATIONAL TELEVISION, INC.

"Every qualified man I train puts in actual hours at my 1,000 Watt Commercial Radio Station! When you have completed my training course, you are a tested radio and television expert—ready to step into the BIG PAY class! You have had actual experience behind you in genuine radio broadcasting work which gives you preference in any radio job. The hours you spend in my ultra-modern, "Hi-Fidelity" commercial station W9XBY and my licensed television experiment station W9XAL mean dollars to you. Never before have you been offered so great an opportunity! Tune in on "Hi-Fidelity" Station W9XBY—1530 kilocycles.

Get your license while learning

A government operator's license is a passport to a real job with a future! My students qualify for their licenses and get certified service records while learning. FREE employment service for life on graduation. No previous experience needed. Write today and let me point the way to the highest-pay radio jobs!"

MAIL TODAY

S. Q. Noel, Pres. First National Television, Inc.
(Training Division)
Dept. OC-8, Power and Light Bldg., Kansas City, Mo.

Without obligation, send me postpaid FREE Illustrated Folder telling about new opportunities in radio and television. I am 17 years or older.

Name _____ Age _____

Address _____

SPECIAL OFFER 15-WATT P. A. SYSTEM As Illustrated

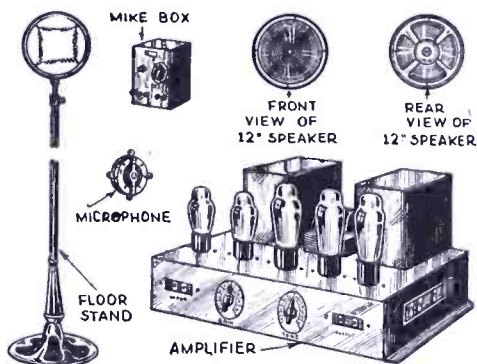

YOUR PRICE **\$35⁹⁵**

Here's what you get:

- 1—15-watt (undistorted output) amplifier with built-in tone and volume controls
- 2—12" matched dynamic speakers
- 1—Double-button chromium-plated microphone
- 1—Adjustable microphone floor stand
- 1—Microphone input matching stage with gain control
- Set of matched tubes for amplifier comprising: 2—2A3's, 1—5Z3, and 2—53's

This system contains only first quality parts, fully guaranteed.

See page 108 for free Catalog

RADIO TRADING CO.

97 Hudson St. N.Y.C.

HOW TO MAKE A FACSIMILE SENDER AND RECORDER

(Continued from page 85)

must be identical.

The sender contact strips (Fig. 1C) are next prepared. They are cut of thin aluminum and cemented to opposite sides of a suitable piece of thin bakelite. The projecting ends are bent and filed to the shape shown in the drawing. The other ends are bent out at right angles so as to rest in notches cut in the supporting brackets. All insulating material used for this part of the apparatus must be of good quality. The leakage resistance must be many megohms if it is to be effectively short-circuited by a pencil line.

The next step is the construction of the pen-actuating relay. Since this must be operated by the plate current of a vacuum tube it should be of rather high resistance. Very satisfactory results were obtained from the one shown in Fig. 2. It is built around a discarded high ratio A.F. transformer with the windings connected in series. The case is removed and the core dismantled. The "E" shaped punchings are then clamped together by a pair of 1/4-in. square brass rods. Two triangular bearing plates are cut from sheet metal and bolted to the clamping rods. Holes are drilled and tapped for the pointed set screws upon which the armature is pivoted. The armature is built up of the remainder of the punchings clamped together by another pair of brass rods. A support for the pen (an ordinary fountain pen) is made up of sheet metal and riveted to the armature frame. A small spiral spring is used to hold the armature up when no current is flowing.

The parts are now ready for assembly. They are fastened to their base with wood screws as shown in the assembly drawings (Fig. 3A and B) a little care at this stage will be well repaid in time saved later. It is necessary that the parts line up properly and work smoothly. It is especially important that the pen clearance be correct. With the armature down it should clear the printer drum by not more than 1/32 of an inch. Of course it must not touch the drum as it is rotated. With the coil de-energized the pen must press firmly on the drum and draw a uniform line as the drum is turned. The contact points of the sender must both bear firmly upon the drum. A piece of very fine sandpaper slipped under them and twisted with the drum will help to accomplish this.

The two electronic relays are now assembled. The exact arrangement of parts is not important as long as the circuit diagram (Fig. 4) is followed. It was found that the type 19 tube is best suited for this use; operated with the sections in parallel. The 5,000 ohm resistor should be able to dissipate at least five W. The 2,000 ohm variable resistor should be wire-wound for stability and should be able to continuously handle 30 ma. One of these units should be fitted with a keying relay which may well be similar to the pen-actuating relay of the printer. The only difference being that a pair of contacts are arranged so that they are closed when the armature is pulled down.

Of course it is necessary that the sender and printer drums rotate in exact synchronism. If the same A.C. supply is available at both stations, the solution is relatively simple. Some sort of synchronous motor is necessary at each station. In the absence of commercial motors a pair of synchronizing devices such as shown in Fig. 5 may be used in conjunction with two series-type fan motors. To build the synchronizer, cut a 4 in. disk of 3/16-in. bakelite and drill six 1/2-in. holes at equal distances around the circumference. Disks made from 1/4-in.

lengths of 1/2-in. iron rod are forced into these holes, riveted over and filed down level with the surface of the bakelite disk. The bakelite disk is mounted on a shaft with a 1/2-in. worm, which engages a 56-tooth worm wheel. The gears may be taken from one of the popular toy construction sets or purchased from a machinist. A "C" shaped core is built up of overlapped pieces of sheet iron and wound with 1,200 turns of No. 24 cotton enamel wire. The core is placed "astride" the disk in such a way that each of the iron "buttons" in turn completes the magnetic circuit as the disk is turned. To try out the synchronizer, belt a series-wound fan motor to the disk and connect the coil to the A.C. line through a switch. Connect a small neon lamp to the same line and place it near the disk so that the latter is illuminated. Insert a variable resistance of about 200 ohms in series with the motor. Start the motor and manipulate the series resistance until the disk is rotating at such a speed that the iron "buttons," in the light of the neon lamp, appear stationary. Then turn on the coil of the synchronizer. If everything has been done properly the buttons will appear to oscillate and finally come to rest so that one of them is hidden by the core of the coil. When operating in this manner it should be possible to apply a considerable braking force to the pulley on the worm wheel shaft without causing the motor to fall out of synchronism.

To complete the set-up, belt the drums of sender and printer to their respective synchronizing devices and connect the apparatus as shown in the complete circuit diagram, Fig. 6. The contact points of the sender are connected to the input of one electronic relay. The grid bias on the tube is adjusted so that placing the fingers across the points will cause the plate current to drop to about 2 ma. With the fingers removed, the current should build up to about 15 ma. The output of the electronic relay is connected to the keying relay whose contacts are placed in the transmitter negative plate supply lead, in lieu of the conventional key. Make sure that the contacts are arranged so that placing the fingers across the sender points will cause the transmitter to cease operation. The receiver used with this equipment should be provided with an output stage feeding into a low-ratio step-up transformer. The secondary of this transformer is connected to the input of the printer electronic relay. The bias on the grid should be adjusted so that, with no signal, the plate current is zero or nearly so. The output stage of the receiver should provide enough excitation to bring the plate current of the electron relay tube up to about 15 ma. when the signal is picked up. The output of the electronic relay is connected to the pen relay of the printer.

Draw the picture to be transmitted, with soft lead pencil on a piece of hard surfaced paper. Use firm, full strokes and do not attempt any shading. Fasten the picture to the sender drum with a touch of paste and set the drum as far to the left as possible so that the unthreaded portion of the shaft is resting in the left bearing. Place a piece of paper on the printer drum and move this drum also to the left. Start the motors and get them synchronized. During this operation the drums will be turning but will not be moving longitudinally. At a pre-arranged signal give both drums a slight push to the right so that the threads engage. If everything is properly adjusted the picture will be reproduced by the printer.

It should be remembered that government regulations permit amateurs to carry on facsimile transmission only on the 160 and 5 meter bands. A license is required for radio, but not for wired transmission.

Fig. 5, below. A motor synchronizing unit. Fig. 6, right. Circuits for sender and recorder units

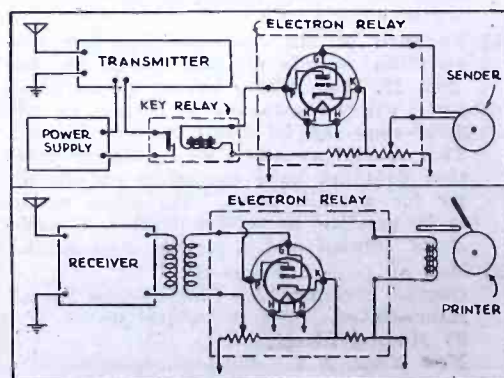
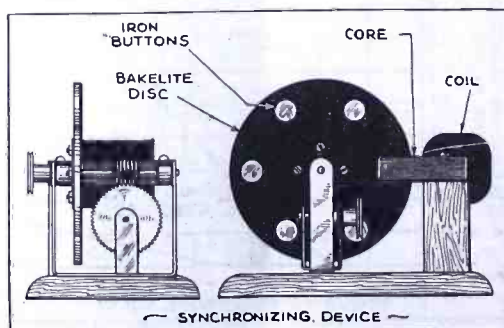

Please Say That You Saw It in RADIO-CRAFT

THE LATEST RADIO EQUIPMENT

(Continued from page 87)

produce a range of A.F. beat notes which are amplified by two stages of A.F. amplification. Frequency range, 20 to 10,000 cycles. The 6-in. dial is provided with a 7 to 1 vernier drive. Output up to 5 V., with less than 5 per cent distortion. 200- and 500-ohm output impedances. Employs 6.3 V. tubes; may be operated from 6 V. "A" and auxiliary "B."

"MATCH BOX" VELOCITY MICROPHONE (768)

(Amperite Corp.)

NEWEST in velocity microphones is a "junior" model for lapel use. Its output is constant with any position of the speaker's head. Total weight, 8 oz. Obtainable with 50- or 200-ohm output impedance. Frequency response, 60 to 7,500 cycles; output, -68 db. (open line). "Mike" cable may extend to 2,000 ft.

TESTER FOR THE NEW METAL TUBES (769)

(Supreme Instruments Corp.)

INCLUDED in this instrument are sockets and testing facilities for the new 8-prong tubes. Also the following features are incorporated: (1) English-reading test of all tubes without the use of adapters; (2) neon test of interelement leakage; (3) neon test of condenser leakage; (4) English-reading check of electrolytics; (5) D.C. voltmeter, 0-1,250 V.; (6) point-to-point resistance test, 0-0.2-meg., and 0-20 megs., using self-contained power supply.

SENSITIVE RELAYS (770)

(Weston Electrical Instrument Corp.)

NUMEROUS industrial and experimental applications demand the use of sensitive relays. New types are designed to close external circuits on only 10 microamps. Other models with adjustment control of the external-circuit closing contacts operate on 4 milliamperes.

17 W. AMPLIFIER (771)

(The Webster Company)

SIZE is a feature of this microphone, phono, or radio amplifier, which measures only 8 x 8½ x 13½ ins. Tone control, and excitation for 2 dynamic speakers are incorporated. Frequency characteristic, flat from 60 to 10,000 cycles. Uses one 57, three 2A5s, and one 5Z3. Input: 200 ohms and high impedance; output, 3 and 6 ohms. Current for one microphone is provided. Operates on 110 V. A.C.

SMALLEST NEON LAMP (772)

(Littelfuse Laboratories)

A NEW line of tiny neon pilot lights for operation on standard power lines consume only about 1 ma.; life, 3,000 hrs. Bulb measures only 1 x ¼-in. dia. Useful for indicating open- or closed-circuit conditions; an additional contact permits use without limiting resistor.

CATHODE-RAY TUBE FLUORESCENT COMPOUNDS (773)

(Pfaltz & Bauer, Inc.)

COMPLEX chemical compounds in the form of fine free-flowing crystalline powder are available for television purposes, and wherever excitation by ultra-violet or cathode-ray beams

is desired. Available with or without after-glow characteristics. Colors: white, sepia, pale-green, purplish red, and sap-green. The powders are applied evenly on the glass by means of an airstream after mixing with a binder.

RACK-AND-PANEL RECORDING AMPLIFIER (774)

(Universal Microphone Co.)

IN CLASS A connection and having a frequency range substantially flat from 40 to 8,000 cycles, and an output of 12 W. with less than 2 per cent harmonic distortion. This 3-stage amplifier consumes 65 W. Ranges of 0.1- to 100 V. are provided. Input and output impedance combinations are adjustable. This amplifier is transformer coupled; laminated-iron shelving separates stages.

ALL-WAVE A.C.-D.C. MANTEL SET (775)

A POPULAR demand for a powerful set of small dimensions resulted in the design of this 6-tube set, which utilizes the types 6A7, 78, 77, 76, 43 and 25Z5 tubes. Cabinet is 15 ins. high.

NEW S.-W. COIL KIT (776)

A WELL-KNOWN technician has developed the coil kit illustrated. It features the use of the coil form both as low-loss winding support and finger grip for removal.

PORCELAIN-CORE RHEOSTATS (777)

A PREVIOUSLY-AVAILABLE rheostat built up of a resistance winding over a porcelain core is now made in an optional design incorporating an off-on switch. Power-handling capacity up to the requirements of industrial apparatus may be obtained.

READERS' DEPARTMENT

(Continued from page 84)

enough to repair a difficult set, but suppose every other component is of a different style and type? The service problem involves, then, not only locating the fault, but also the greater one of getting suitable replacements.

GLAD TO KNOW WE PLEASE!

Editor, RADIO-CRAFT:

May I commend your continuous efforts to present RADIO-CRAFT to its many readers in the most attractive form possible? I refer specifically to the new styling of the sub-heads as employed in the April issue.

While this is but one of the many refinements I have noticed in your presentation over a considerable period I believe the present distinctive styling will be welcome to the busy technician both from a standpoint of original digestion and constant reference, as the typography is both compelling and pleasing.

Both as an engineer and as one who has had a somewhat comprehensive experience in the newspaper field I am in a position to appreciate the dual problem of keeping abreast of the developments in the field and also maintaining at a minimum the percentage of error inherent in this type of work. I am glad to say that RADIO-CRAFT is outstanding in both these respects and that its popularity is truly deserved.

E. C. ROBINSON,
319 East 10th Street,
Michigan City, Ind.

Left, No. 775. An all-wave A.C.-D.C. Mantel Set. Below, No. 777. A porcelain core type rheostat

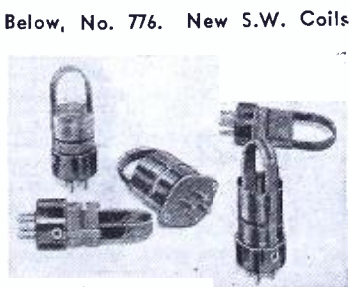
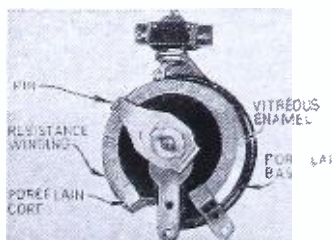
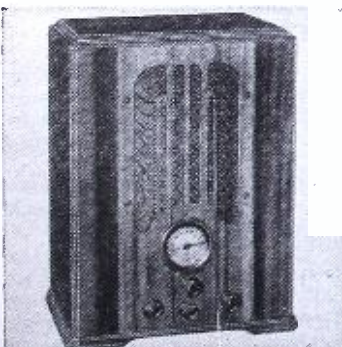

Below, No. 776. New S.-W. Coils

HICKOK

MASTER SERVICE ALL WAVE

Radio and Audio Frequency OSCILLATOR

with Frequency Modulation for Oscilloscope Use.

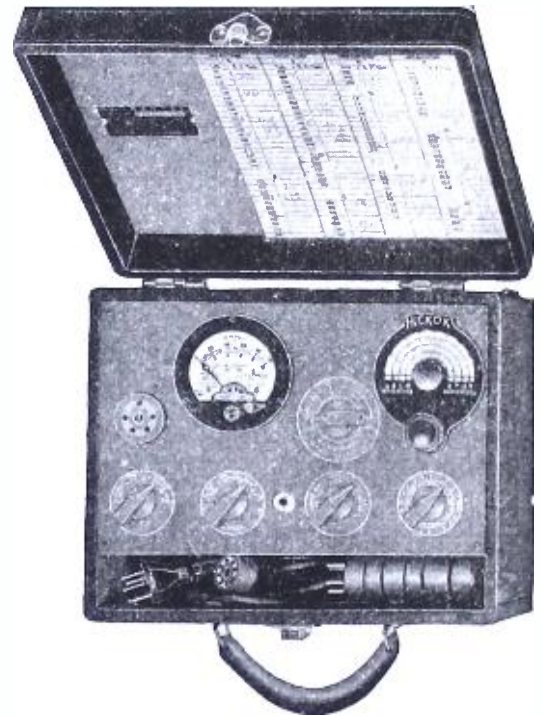

The most complete meter equipped oscillator available—in addition to the standard features of all oscillators it has

8 EXCLUSIVE HICKOK FEATURES

including built-in output meter; stage to stage alignment and check; direct reading dial to 40 Megacycles; 1 radio frequency corrector; circuit equivalent of five tubes.

OTHER IMPORTANT FEATURES

Revolutionary design—calibrated audio frequency output continuously variable from zero to ten thousand cycles. Actual tests show frequency stability of .05%. Triple shielded—Shielded output leads. This is the Oscillator offered as a prize in the Radio-Craft Contest—see page 14, July issue.

All Hickok Oscillators, Tube Testers and Set Testers are equipped to test metal shielded tubes. Write for NEW CATALOG giving complete description, specifications and prices of this and other Hickok Radio Servicing Instruments.

THE HICKOK ELECTRICAL INSTRUMENT COMPANY

10510 Dupont Ave.
Cleveland, Ohio

ATTENTION!

SERVICEMEN, DEALERS, AMATEURS, EXPERIMENTERS

The first annual Philadelphia Radio Trade Show will be held July 8th to 13th, at the Northwest Corner of Seventh & Arch Streets.

Fifty of the leading radio parts manufacturers will exhibit their new 1936 products.

Prominent speakers every day during afternoon and evening.

Come One—Come All!

Plenty to eat and drink—FREE.

All are cordially invited to attend.

This show sponsored by the RADIO ELECTRIC SERVICE CO., INC. who will permanently occupy these new quarters after the show.



FREE

IMPORTANT ILLUSTRATED BUYING GUIDE FOR RADIO EXPERIMENTERS, SERVICEMEN, AND SHORT-WAVE FANS.—32 Pages—Two Colors—Profusely Illustrated This Book Will Save You Money! Packed between the covers of this 32-page book is a tremendous array of modern radio equipment and other electrical and scientific merchandise—the very material for which you have been looking—and at prices which cannot possibly be any lower. Radio sets and parts, low

priced microscopes, jeweled compasses, complete public address equipment, field glasses, the finest short-wave equipment available, crystal receivers, radio replacement parts, etc., etc. Name the item—and it's in the book! This amazing book will show you how to save money. You save by buying at the lowest possible prices. Why not start saving now? Don't delay! Write today! Send postcard or letter. Book by return mail. It's free!

RADIO TRADING CO.
97 Hudson St., New York City

Radio Dealers & Servicemen!
New!

16 mm. Sound on-Film Ready! LOWEST PRICES

LARGE, QUICK PROFIT

Sell Sound Equipment to theatres. We supply EVERYTHING! FREE CATALOGS!

S. O. S. CORP.
1600 B'way., N. Y. C.

TELEVISION EXPERIMENTERS

We carry in stock at all times a complete line of PHOTO-CELLS, CRATER LAMPS and RELAYS

Get our prices on your special equipment first

M. & H. SPORTING GOODS CO.
512 MARKET ST. PHILA., PA.

WHEN BETTER AERIALS ARE MADE LYNCH WILL MAKE THEM... AND OTHERS WILL TRY TO COPY THEM

Write for Free Bulletin on LYNCH PATENTED and GUARANTEED Noise-Reducing Antennas for Home, Auto Use.
ARTHUR H. LYNCH, INC., 227 Fulton St., N. Y.
PIONEER OF NOISE-REDUCING AERIALS

INTERNATIONAL RADIO REVIEW

(Continued from page 89)

chanical" scanner for the 30-line pictures is shown in Fig. C.

This unit which is sold in kit form, was recently shown in several English magazines, and presented as a good set for the television beginner to start on. It consists of a 16-in. disc, a universal motor, a neon tube and two lenses, plus the drilled chassis, shown.

A CATHODE-RAY CIRCUIT

FOR those experimenters who are interested in a practical cathode-ray television receiver circuit, we are reproducing one which was described in the latest issue of THE BROADCASTER AND WIRELESS RETAILER.

An examination of the circuit shows the tuning circuit, amplifier, 375-cycle time base, 12½-cycle time base and the frequency-locking controls.

The tuning, it will be noticed, is accomplished by a single tuned circuit. This is required to supply the broad tuning band needed for television reception.

The 375-cycle and the 12½-cycle oscillator tubes, for vertical and horizontal focusing, are power amplifier tubes, fed with 1,000 V., while the plates of the cathode-ray tube used in this receiver require 1,500 to 2,000 V. These high voltages may be obtained from well-filtered power units, receiving their power from the A.C. lines.

It was explained in the article that because of the individual focusing controls, that much greater flexibility will be obtained with this type of receiver than with the usual mechanical scanning methods. This particular set was designed for 30-line scanning, but the number of lines is simply controlled by the time base frequencies, which can be varied to suit the scanning rate.

GERMAN TELEVISION TRUCK

SINCE the high-definition transmitter was started in operation, in Berlin on ultra-high frequencies, some 18 months ago, the interest in this side of radio reception has increased tremendously.

To permit the transmission of outdoor events, a special truck has been set up with complete facilities for filming the events, which can then be televised, using the film as an intermediary. The process is arranged so that transmission can take place some 30 seconds after the scene has been filmed.

TELEVISION IN THE SCHOOL

(Continued from page 90)

intensity is obtained on images 10 or 12 feet square with this system and equipment.

With continued development and improvement of the cathode-ray tube, iconoscope and other electronic devices, as well as the optical system, lenses, lighting and light-ray control, television is steadily forging ahead and is rapidly becoming a factor to be reckoned with industrially. With European countries pushing television development both for commercial and political reasons, coupled with the recent announcements by reputable industrial organizations in this country, publicizing their new plans for commercial television, it is sincerely felt that any individual who plans to adopt radio work as a vocation, will display good business judgment by thoroughly familiarizing himself with television principles, equipment and new developments.

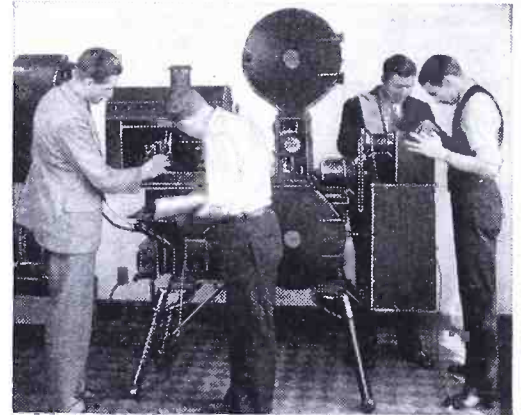

Two interesting views of school television

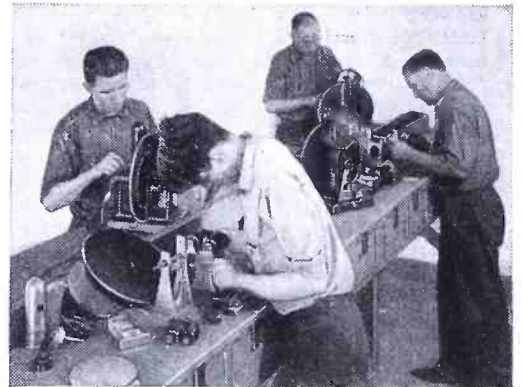

A BEGINNER'S "2-in-1" A.F. AMPLIFIER

(Continued from page 83)

- One Hammarlund 6-prong socket for V.
- One Electrad volume control 0.5-meg., R1.
- One Amperite filament ballast for single 19 tube (on 4½ V.), R2.
- One M. & H. off-on Switch, Sw.
- One Cornell-Dubilier paper condenser, .002-mf., C1.
- One Cornell-Dubilier paper condenser, .05-mf., C2.
- One Sylvania type 19 tube, V1.
- One 5¾x7 in. metal panel.
- One 4x7x½ in. thick wood baseboard.
- Misc. hardware.

(Continued on page 122)

TECHNICIANS' DATA SERVICE

(Continued from page 104)

values and voltages of condensers required in the various circuits of radio receivers and amplifiers, and how to locate radio troubles due to defective condensers. Includes data on condenser calculations.

76. FACTS YOU SHOULD KNOW ABOUT CONDENSERS. A folder, prepared by the Sprague Products Co., which explains the importance of various characteristics of condensers, such as power-factor, leakage, capacity and voltage in determining the efficiency or suitability of a given condenser to provide maximum filtering and safety in operation.

THE DESIGN OF TELEVISION TRANSFORMERS

(Continued from page 92)

charge takes place before a consecutive signal voltage is built up across Rp. For this reason Rg must be made smaller, for any increase of C1. But, from the point of view of gain in tube V2, Rg should be made as large as possible. At the same time, C1 should be as large as possible because the loss of voltage through C1 is inversely proportional to the frequency and directly proportional to the impedance of C1, which depends upon the capacity of C1 at a given frequency. (In television amplifiers C1 varies between 0.1- and 1.0 mf.) It should be noted here in passing that such coupling condensers are to be completely free of any leakage, as a high positive D.C. grid voltage is otherwise impressed upon V2 (causing it to draw grid current, with resultant harmonic distortion).

The above discussion explains in part the reason for the losses of both the high and the low frequencies, and a typical response curve of a resistance-capacity coupled stage is reproduced in Fig. 1, from Prof. Morecroft's "Principles of Radio Communication."

At the same time the maximum amplification of a resistance-capacity coupled stage is less than half that of the amplification factor of the tube, necessitating the use of many more amplifier stages than if transformer coupling was used throughout. Thus, each additional stage of amplification adds its share of distortion to the total output, with an increase in circuit instability. There is also a high-frequency loss in the tube, due to its internal capacities, which increases with the number of tubes employed.

Better frequency response curves may be obtained if "equalizers," such as the series type described in the July, 1935 issue of Radio-Craft, are employed. However, for these equalizers to be fully effective it is necessary that they be constructed similarly to the A.F. transformers described below.

TELEVISION TRANSFORMERS

"Wide-frequency-band"—"high-fidelity"—"high-gain" transformers were available to the laboratories and universities quite some time ago, but only now are they being introduced to the radio and P.A. public, at reasonable prices. The use of such high-gain transformers in conjunction with television amplifiers, reduces the number of stages required, produces greater circuit stability, better quality and the tubes fare better, as the corresponding D.C. grid resistance is thereby many times smaller, eliminating grid current with a resultant reduction of harmonic distortion. Now, as push-pull amplification is particularly desirable in the power output stage, the construction and theory of such a transformer will be briefly given below. However, in order for such an A.F. transformer to be of the "wide-band"—"high-fidelity" and "high-gain" type, the following characteristics are required:

(1) Balanced construction, as to resistance, capacity and inductance.

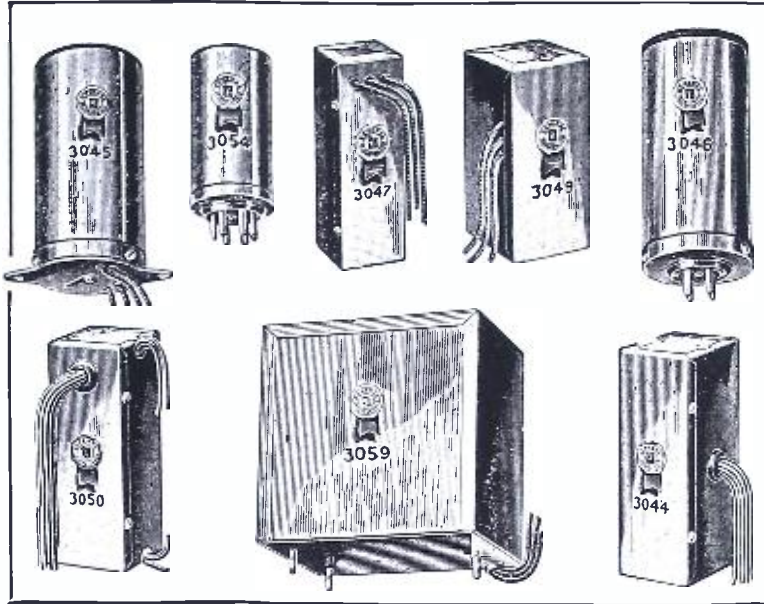

AUTO RADIO

"General" Quality Vibrators for 90% OF SETS IN USE

To insure the most permanent and dependable service General Full-wave Vibrators are provided with the highest grade Swedish spring steel reed and with oversized tungsten contacts—assuring long life.

Free for the Asking!

Auto-Radio Vibrator Guide listing 220 models of radios on which you can replace the vibrator with one of 22 General Units.

General Transformer Corporation
504 S. Throop Street, Chicago, Ill.

---MAIL THIS TODAY---
GENERAL TRANSFORMER CORPORATION
504 S. Throop St., Chicago, Ill.
Send me without charge a copy of Vibrator Guide with name of nearest distributor.
Name
Address
City State.....



THOR A. C. AMPLIFIER

Model 3F.
4 WATTS 1-57 1-2A5 1-80

No single feature has been overlooked in making this an outstanding amplifier. The circuit is one of simplicity—yet employing the latest in tube circuit design.

This 3-tube A.C. Amplifier Kit with complete parts for construction, including wiring diagram and instructions..... \$5.95

DYNAMIC SPEAKER \$2.50 EXTRA — SET OF MATCHED TUBES \$1.52 EXTRA. Kits shipped Ready Mounted. Send for FREE Circuit Data.

BRAND NEW!
A. C. Amplifier
Type 250
Sold in Kit Form

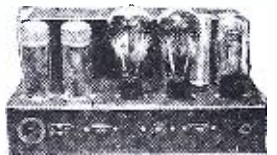

This latest Thor Amplifier employs five tubes—1-57, 2-50, 1-56 and 5Z3. Complete list of parts, including easily followed wiring diagram. Build this amplifier for phenomenal results.
Complete kit..... \$18.50
14" Dynamic Speaker Special..... \$6.45

THOR RADIO CORP.

167 GREENWICH ST.

MAIL ORDERS PROMPTLY FILLED
NEW YORK, N. Y.

- (2) Low D.C. resistance.
 - (3) High gain.
 - (4) Low distributed capacity.
 - (5) Efficient core of high permeability.
 - (6) Small overall size.
 - (7) Minimum hum pick-up.
 - (8) Noiseless performance at high or low operating levels.
 - (9) Full impregnation and effective shielding.
- Taking each of these items in their numerical order, they are analyzed as follows.
(Continued on page 111)

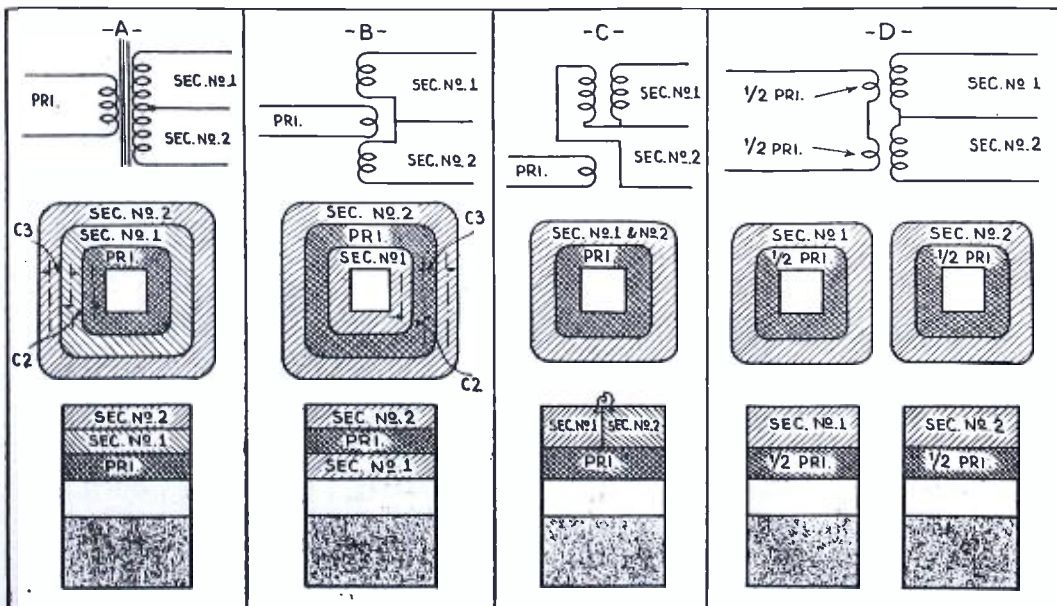
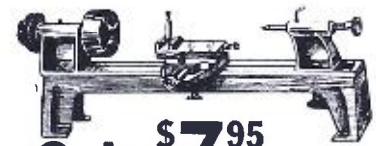

Fig. 2
Four different types of transformer windings explained above

Please Say That You Saw It in RADIO-CRAFT

COMBINATION WOOD and METAL CUTTING LATHE



Only \$7⁹⁵ (Less Chuck)

\$3.50 extra for chuck (4 jawed, 3 in.)

LENGTH: 20 in.
WIDTH OF BASE: 4 in.
HEIGHT OVERALL: 9 in.
WEIGHT: 21 lbs.
SPEED: Two-step pulley.
FINISH: Baked on GRAY ENAMEL.
COMPLETE with Compound Slide rest.

65c extra for 5" woodworking "T" rest

Slide rest having Swivel base and tool holder.
Large oversized bronze bearing. Accurately planed bed, machined face plate. Hollow Spindle, 5 in. swing.
Standard Morse tapers; 13 in. between centers.
Shipping weight: 26 lbs.

Send \$2 deposit balance C.O.D. Sold on money-back guarantee basis. DO NOT WRITE FOR CATALOG.

WELLWORTH TRADING COMPANY RC-835
560 W. Washington Blvd., Chicago, Ill.

Enclosed you will find my remittance of \$..... for which please send me

- Lathe as described
- by express collect
- or balance C.O.D.

Name
Address
City..... State.....

G. E. MOTORS

These motors were manufactured by the General Electric Company and originally intended for use by a large manufacturing company.

Here are the specifications: 1/30 h.p. 4800 R.P.M. Universal A.C. and D.C. 110 volts instant reverse. Size: Diameter 3 inch, length 5 inch.

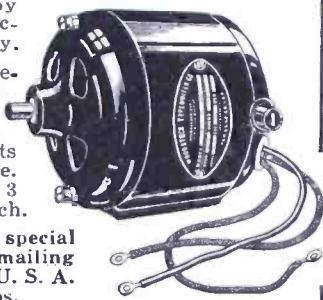

Add 25c for special packing and mailing anywhere in U. S. A. Ship. Wght. 3 lbs.

\$2.45 Each DO NOT WRITE FOR CATALOG

WELLWORTH TRADING CO. RC-8
558 W. Washington St., CHICAGO.

Enclosed find \$..... for which ship:
 G. E. Motors @ \$2.70 each (Prepaid in U.S.A.)

Name.....

Address.....

City..... State.....

CLASSIFIED ADVERTISEMENTS

Advertisements in this section are inserted at the cost of twelve cents per word for each insertion—name, initials and address each count as one word. Cash should accompany all classified advertisements unless placed by a recognized advertising agency. No less than ten words are accepted. Advertising for the September, 1935, issue should be received not later than July 5.

A.C. GENERATORS

TWENTY PRACTICAL AND LOW COST CHANGES converting Ford, Dodge, or Chevrolet generators into new generators and motors 100-500 watt capacity, direct or alternating current, with six to 400 volts for radio operation, power, light, or welding. Also instructions for re-winding armatures; 350 definitions of electrical terms, etc. All in new, revised book with simplified instructions and illustrations. Endorsed by thousands—Only \$1.00 postpaid, Auto Power, 414-C, S. Hoyne Ave., Chicago.

ELECTRICAL SUPPLIES

INSULATION, WIRE, VARNISHES, SUPPLIES, ETC. Send 3c stamp for bulletin. Auto Power, 414-C S. Hoyne Ave., Chicago.

PATENT ATTORNEYS

PATENTING INVENTIONS IS MY SPECIALTY through 28 years; Sterling Buck, Registered Patent Attorney 7780, 629 F, Washington, D.C. (Free Booklet-R).

SOUND EQUIPMENT

SOUND EQUIPMENT: USED FROM WORLD FAIR. Dupont Sound Systems, 3970 Archer Avenue, Chicago, Ill.

TELEVISION EQUIPMENT

TELEVISORS, DISCS, NEON, CRATER AND CA-thode Ray Tubes. Arthur Pohl, 2134 Palms Ave., Detroit, Michigan.

Be Your Own Employer RUN INDOOR POULTRY FARM

A Complete Plant Under ONE Roof



Amazing modern method affords new opportunities. Using the ARNDT System, you can successfully raise poultry in garage, remodeled barn, abandoned factory or any out-building. Thousands are doing it. Part or full-time business. No need for previous experience; we teach you everything you need to know. Write for illustrated literature.

M. H. ARNDT MFG. CO.

Dept. 43 TRENTON, NEW JERSEY

Neon Continuity Tester

An indispensable device for service men, dealers, experimenters. Tests mica and paper condensers—determines continuity of circuits—tests insulation for leakage—gives estimate for resistance values—ready for instant use—no batteries are needed—just plug in A.C. or D.C.—will last forever.

Special introductory price **\$1.50** postpaid.

Jobbers, dealers write for quantity prices
Radio Design Co. 98 Park Place
New York, N. Y.

AN 8-TUBE SHORT-WAVE KIT-SET

(Continued from page 90)

coils until a maximum response is obtained, keeping the input from the oscillator as low as possible or the sensitivity control of the set turned low. The same procedure is followed through each of the succeeding bands.

The set is now ready for trial under actual receiving conditions. The test oscillator is disconnected from the receiver and if a standard antenna is to be used, a small jumper wire between the antenna and ground binding post is left in position and the antenna hooked to the remaining binding post farthest away from the ground. If a doublet antenna is to be used, the jumper is removed and the two leads from the antenna hooked to the binding posts provided for them.

LIST OF PARTS

- One Gen-Ral foundation kit consisting of chassis and panel;
- One Gen-Ral multi-wave unit, 18 to 1.5 mcs., L1 to L2;
- One Gen-Ral LCX 200D-V-M 507 kc., series-wound I.F. unit, input, top grid, L13;
- One Gen-Ral LCX 200D-V-M 507 kc., series-wound I.F. unit, output, bottom grid, L14;
- One Gen-Ral heterodyne oscillator, 507 kc., L19;
- One General Trans. Corp. or United Trans. Corp. power transformer, PT;
- One General Transformer Corp. or United Trans. Corp. A.F. choke, 200 ohms, Ch.1;
- One Hammarlund band-spread condenser, 140 mmf., C1, C2, C3;
- Two Hammarlund or Eby 4-prong tube sockets;
- Four Hammarlund or Eby 6-prong tube sockets;
- Two Hammarlund or Eby 5-prong tube sockets;
- One Hammarlund or Eby 7-prong tube sockets;
- Six Blan aluminum tube shields;
- One Centralab, or Electrad 15-meg. pot-type volume control with switch, R11, Sw.1;
- One Centralab or Electrad 25,000-ohm rheo-type volume control, R1;
- Two Eby S.P.D.T. rotary-type switches, Sw.4, Sw.5;
- Two Eby S.P.S.T. rotary-type switches, Sw.2, Sw.3;
- Two Eby insulated binding posts, ANT.;
- One Eby plain binding post, GND.;
- One Eby pair phone tip-jacks, J;
- Four Aerovox paper condensers, .05-mf., 200 V., C4, C6, C7, C27;
- Two Aerovox paper condensers, .1-mf., 200 V., C5, C25;
- Three Aerovox paper condensers, .01-mf., 200 V., C8, C10, C11;
- Two Aerovox paper condensers, .01-mf., 400 V., C14, C16;
- Two Aerovox paper condensers, 1. mf., 400 V., C12, C17;
- One Solar or Sprague electrolytic condenser, 5. mf., 25 V., C13;
- One Solar or Sprague electrolytic condenser, 10 mf., 25 V., C15;
- Three Solar or Sprague electrolytic condensers, screw-type mounting, 8 mf., 450 V., C18, C19, C30;

- One Cornell-Dubilier mica cond., 100 mmf., C9;
- One Cornell-Dubilier mica cond., .001-mf., C31;
- Two Cornell-Dubilier condensers, .1-mf., 400 V., C28, C29;
- One Cornell-Dubilier cond., .2-mf., 200 V., C30;
- One Cornell-Dubilier mica condenser, 750-mmf., 6-plate adjustable padder, C21;
- One Cornell-Dubilier mica condenser, .00125-mf., 6-plate adjustable padder, C22;
- One Cornell-Dubilier mica condenser, .0025-mf., 6-plate adjustable padder, C23;
- One Cornell-Dubilier mica condenser, .005-mf., 6-plate adjustable padder, C24;
- One IRC or Continental Carbon Co. carbon resistor, 150 ohms, 1 W., R2;
- One IRC or Continental Carbon Co. carbon resistor, 40,000 ohms, 1 W., R3;
- One IRC or Continental Carbon Co. carbon resistor, 13,000 ohms, 2 W., R5;
- One IRC or Continental Carbon Co. carbon resistor, 500 ohms, 1 W., R19;
- One IRC or Continental Carbon Co. carbon resistor, 20,000 ohms, 1 W., R20;
- Three IRC or Continental Carbon Co. carbon resistors, 250,000 ohms, 1/2-W., R4, R8, R14;
- One IRC or Continental Carbon Co. carbon resistor, 200 ohms, 1/2-W., R6;
- One IRC or Continental Carbon Co. carbon resistor, 25,000 ohms, 1/2-W., R7;
- One IRC or Continental Carbon Co. carbon resistor, 1 meg., 1/2-W., R9;
- One IRC or Continental Carbon Co. carbon resistor, .2-meg., 1/2-W., R10;
- Two IRC or Continental Carbon Co. carbon resistors, .5-meg., 1/2-W., R15, R18;
- One IRC or Continental Carbon Co. carbon resistor, 5,000 ohms, 1/2-W., R12;
- Four IRC or Continental Carbon Co. carbon resistors, 50,000 ohms, 1/2-W., R13, R17, R20, R21;
- One IRC or Continental Carbon Co. carbon resistor, 3,000 ohms, 1/2-W., R16;
- One Blan 6-ft. power cord, with plug attached;
- One Wright-DeCoster 8-in. dynamic speaker, 2,500-ohm field with output transformer for 2A5 tube;
- **One vernier dial;
- *Eight 3/4-in. dia. black bakelite knobs;
- *One 1/2-in. dia. rubber grommet;
- *Three 1/4-in. dia. rubber grommets;
- *Five 2-lug insulated terminal strips;
- *Two 1-lug insulated terminal strips;
- *Two fibre shoulder washers;
- *Two fibre plain washers;
- Two Sylvania, Ken-Rad, or National Union 58 type tubes;
- One Sylvania, Ken-Rad, or National Union 2A7 tube;
- One Sylvania, Ken-Rad, or National Union 2A6 tube;
- One Sylvania, Ken-Rad, or National Union 2A5 tube;
- Two Sylvania, Ken-Rad, or National Union 56 tubes;
- One Sylvania, Ken-Rad, or National Union 280 tube.

(*Miscellaneous hardware—obtainable from Blan the Radio Man, Inc.

**Obtainable from most mail order houses, including Radolek; Wholesale Radio Service Co., Inc.; Coast to Coast Radio Corp., M. & H. Sporting Goods Co.; Allied Radio Corp., etc.)

The circuit of this 8-tube superhet. receiver

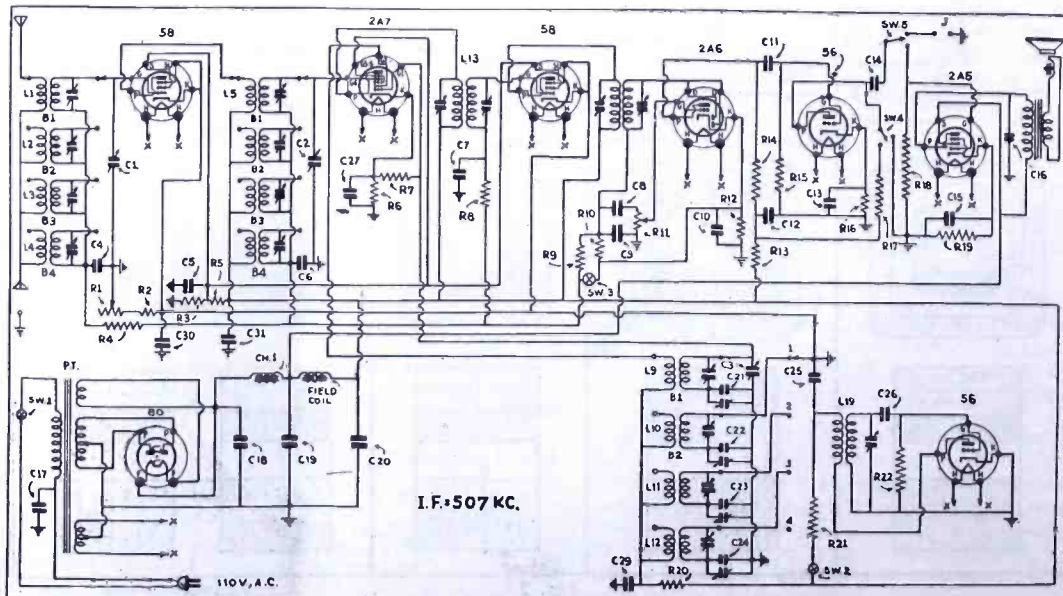

Please Say That You Saw It in RADIO-CRAFT

THE DESIGN OF TELEVISION TRANSFORMERS

(Continued from page 109)

(1) A quick glance at Figs. 2, A to D shows clearly that *only in C and D is condition A of the above list fulfilled.* Only in these two transformers is the D.C. resistance the same in both secondary windings; the capacity between each secondary and primary winding the same; and each secondary winding having exactly the same resistance, inductance, and capacity. This condition is of greatest importance if true push-pull amplification is desired, as then the signal voltages impressed upon the push-pull grids are identical, in (a) magnitude, (b) in phase and, (c) in frequency.

In Fig. 2C, secondary winding No. 2 is wound in the opposite direction to Sec. No. 1, a costly difficult procedure. Note also that there is a capacity between the two secondary windings and a relatively large capacity between primary and secondary windings. For these reasons all further discussions will be made in reference to the transformer shown in Fig. 2D as being the only suitable construction for high-fidelity transformers.

(2) The unusually small size is made possible by the use of high grade laminations. Thus the average diameter of the primary winding is only 0.6-in. and the average diameter of the secondary is about 0.8-in., resulting in relatively very low resistance coils.

(3) Higher gain is obtained because the loss in the transformer coils due to the D.C. resistance is reduced to a minimum, and because a larger step-up ratio may thus be obtained without an appreciable increase in resistance, or in the distributed capacity of the coils.

(4) The smaller the distributed capacity, the lower the losses at the higher frequencies. But as capacity is mainly a function of the size of the masses involved, these small coils have an unusually low distributed capacity, and therefore, a better high-frequency response.

(5) High permeability alloy laminations are very expensive, practically prohibiting their use in large coils. However, since less than a pound of core material is required for this transformer, the unit can be made and sold at a reasonable price.

(6) The cross-section of this core is only 1/2 x 1/2-in. The maximum diameter of the two identical coils is only 1 in. and the maximum length is only 1 1/2 ins. The laminations are of a high-permeability alloy. The total assembly is small enough to be housed in a case measuring only 2 1/2 x 2 1/2 x 2 3/4 ins.; this case is shown in the background of Fig. A.

(7) As shown in Fig. 3, one of the two coils is turned upside down, the total voltage of the secondary winding being developed across the point X1 and X2. Now if an external field, such as produced by a power transformer passes through both coils, as shown by the arrows "HF," they produce two hum-frequency voltages of equal magnitude but 180 degrees apart electrically, thus balancing out each other without introducing any hum into the transformer. A high-permeability alloy casting houses this transformer to prevent any hum being induced in case there are more "HF" lines flowing through one coil than through the other. Perfect hum-free operation is thereby obtained.

(8) These transformers are noiseless because they are space-wound, preventing shorted turns; and because only highest-grade wire and insulating materials are employed.

(9) All coils are thoroughly freed of any moisture or air; they are then heat-treated, and impregnated in moisture-proof compounds. The complete transformers are, in turn, placed into the castings which are also sealed with a similar insulating compound to insure lifelong performance.

The frequency response of these transformers extends well beyond the audio frequency range, and by proper selection of the values in one or more "equalizers" (see reference, above) may easily be designed, in conjunction with the other component characteristics in the respective amplifier stages, to encompass the 50 kc. modulation range (100 kc. signal band width) used in television.

A CONVERTIBLE AUTO-TYPE P.A. SYSTEM

(Continued from page 91)

must be able to drive the car while the amplifier is "blasting away."

Good use has been made of the newer combination tubes, particularly the 6A6 and the 6B5. As the diagram shows, the circuit comprises one 6C6, one 6A6 and two 6B5s, which are actually the full equivalent of seven ordinary tubes!

The microphone (the crystal type is recommended) is connected across a .5-meg. potentiometer, which is the "gain" or volume control of the system. The arm of the pot. goes to the control-grid of the 6C6, which functions as a straight pentode amplifier, resistance-capacity coupled into a 6A6 double triode.

The 6A6 works as a phase inverter to give all the advantages of push-pull amplification without the use of interstage transformers, which are costly and notoriously subject to hum pick-up and coupling troubles.

The 6B5s comprise, in effect, four tubes. The triode sections consisting of the floating cathode, grid and plate are driven in push-pull by the 6A6, and they in turn drive the second triode sections in push-pull. The plates of the first sections are connected directly to "B plus." The plate circuits of the second sections, however, are conventional and require a regular output transformer. This has the usual low and medium impedance secondaries for voice coil and line connections.

The filaments of the tubes run directly off the car battery. Plate supply is furnished by a dynamotor, fitted with a filter system to eliminate commutator ripple.

The whole amplifier, including the dynamotor, is contained in a steel box measuring only 12 x 7 1/4 x 7 1/2 ins., which is readily mounted under the dashboard. On the front panel are the main battery switch Sw.1, the tone control resistor and a pilot light. The driver of the car can easily reach these and turn them on or off when he starts or stops the car.

The gain control, R1, and the dynamotor switch, Sw.2, are also mounted on the amplifier panel, but are cable-controlled from the steering column. This arrangement permits the tubes to remain lighted (once Sw.1 has been closed), and at the same time allows the driver to cut off the dynamotor when the microphone is not actually being used. The car's battery is thus relieved of the heavy load of the dynamotor during idle periods.

The amplifier as described is complete for 6 V. service. For A.C. operation, a separate little power pack is supplied. This consists merely of a power transformer, 83 rectifier and filter, with a separate filament winding for the tubes in the amplifier. A plug-and-cable arrangement (omitted from the diagram for the sake of clarity) enables the Service Man to shift from battery to A.C. operation in a few seconds. The plug connections are so fixed that the plus lead from the high-voltage dynamotor is opened when the A.C. pack is used; (otherwise, the D.C. from the power pack would make the dynamotor run backwards, generating six volts on the input side!).

The technical characteristics of the amplifier are as follows: Peak output—18 W. Maximum output into plate impedance—15 W. Maximum output into 500-ohm line—12 W. Harmonic content at rated maximum outputs—6 per cent. Gain—104 db. Power consumption—84 W. (14 amperes from a 6 V. battery).

The high gain of 104 db. allows the use of crystal microphones without the bother of pre-amplifiers. The output of 12 W. means that the system will fill the average hall or meeting place with plenty of reserve.

The auto-P.A. unit in use

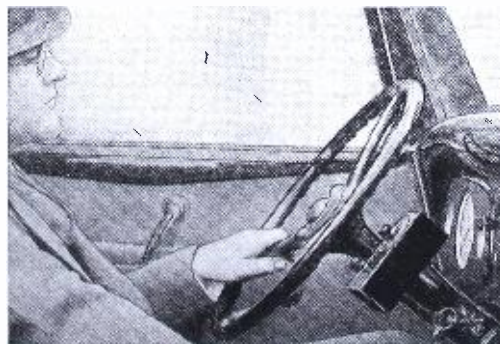

Please Say That You Saw It in RADIO-CRAFT

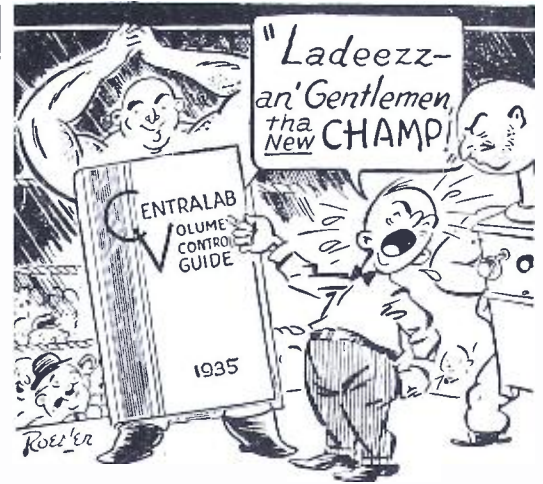

he takes all comers

The new CENTRALAB VOLUME CONTROL GUIDE is the serviceman's champion... he "takes on" the most difficult job and throws it for a victory.

This new 1935 revised edition represents the accumulated experience of engineers, consultants and servicemen—all of whom have contributed to make this the most accurate and complete Volume Control Guide yet published. In addition it contains a valuable cross index.

Now you can get the exact, accurate dope on every service job, for there is a CENTRALAB RADIO H M specially made for every replacement.



Every Radio Service Man should be a member of the Institute of Radio Service Men

Centralab
Division of Globe-Union Mfg. Co., Milwaukee
MILWAUKEE, WIS.

THE Only 100% RADIO CATALOG

IT'S **Free** 1935 **RADIO** GUIDE

THOUSANDS OF PARTS SET-BUILDING KITS TEST INSTRUMENTS PUBLIC ADDRESS SHORT WAVE GEAR ALL-WAVE AUTO BATTERY RADIOS

RADIO

PARTS-TUBES TEST EQUIPMENT SERVICEMEN'S SUPPLIES, ETC.

ALLIED RADIO CORPORATION

833 W. Jackson Blvd., Chicago, Ill. Dept. D
Send me your FREE Spring & Summer Catalog.

Name

Address

EVEREADY SERVICE CEMENT
"The Original Speaker Cement"

The best Cement for replacing Speaker Cones, and repairing old, rattling, torn Cones, and other Radio Work.

Fast Drying — Vibration Proof
Ask for it by name, at your jobbers

General Cement Mfg. Co., Rockford, Ill.

SOUND IN FOUR DIMENSIONS

Makes the Phantom of Music a Reality!



Out of Columbia Sound Laboratories comes something new—Two and Four Dimensional Sound Systems—the greatest developments in scientific sound reproduction. They are not merely new models—but new results—something that you can hear and sense. If you intend purchasing an amplifier, be sure to first send for our **FREE** Public Address Bulletins of Two and Four Dimensional Sound Systems.

Dealers, Distributors and Jobbers; Write for attractive proposition.

free

COLUMBIA SOUND CO. Inc.
135. LIBERTY ST. NEW YORK, N.Y.

cessful at the broadcast frequencies, with certain cores, by reason of the fact that the iron was not divided into small enough particles to keep the eddy current loss in the core material desirably low.

Because of high loss, which might occur in the core material, any decrease in copper loss caused by using a core of high loss and high permeability may then be offset by the losses in the core material itself.

Powdered iron cores showed more signs of success but here, too, the losses were high unless the particle-size was reduced to microscopic dimensions and then each particle insulated from each other. With powdered iron cores, the prevailing trouble was the non-uniformity of the product, both with respect to inductance and to losses. It seemed difficult to make the cores commercially uniform.

The difficult problem of obtaining a pure powdered iron core with particles of sufficiently small size, sufficiently well insulated from each other that it would be advantageous to use the material at broadcast frequencies has finally been solved by the special, patented, "ferrocart" process which reduces the particles to almost atomic fineness. These particles, well insulated from each other, are bound together, making a core that gives high permeability with very low loss in the core material. (See "Ferrocart" R.F. coils," *Radio-Craft*, December 1933; also, "Permeability Tuning", November 1931.—Ed.)

The use of one of these cores in a properly designed broadcast coil permits a given inductance to be obtained with approximately 30 to 50 per cent less wire length in the coil, bringing down the copper loss in almost direct proportion!

This realization of the engineers' dream makes possible gain and selectivity in small coils that has heretofore been only a laboratory experiment, but not a commercial possibility. However, even with this, any coil as near perfection as possible at the present time, must be utilized intelligently if full advantage is to be made of its theoretical possibilities. For example, if this "ferrocart" core broadcast secondary is to be used in a high-impedance antenna coil (diagrams of which are shown herewith), the coils may be damaged by the proximity of a primary wound with too large a size of wire, causing high eddy current loss in the conductors of the primary circuit. The remedy for such loss is to use either a very fine size of wire for the primary or to use a sub-divided conductor (Litz. wire).

In addition to the magnetic coupling, most high-impedance antenna coils have an appreciable capacity coupling between the grid and the antenna. In order to eliminate any losses in the capacity, it is necessary to use either an adjustable mica coupling condenser with plates partially open or to use an air-dielectric condenser. (The commonly used capacity turn, in which the capacity from a wire through its insulation to the secondary is used as the coupling condenser, has losses that may reduce the gain of a properly designed "ferrocart" type antenna coil 20 to 30 per cent!)

OPTIMUM SIZE OF SHIELD CAN

The above antenna coils with a finely-divided conductor for the primary and a special high-grade coupling condenser must now be shielded to fit most applications, particularly for automobile sets. The size of the shield is of considerable importance and it will be found that the shield size may be reduced by steps down to a certain value with very little effect on the performance of the coil but that to reduce the shield size below a certain optimum value, changes the effective inductance and losses of the coil at an astonishingly high rate! The shield must, therefore, be selected with care.

From all of the foregoing it is obvious that the application of ferrocart (the engineers' ideal of a satisfactory core material) is a difficult research problem to obtain the best balance between the copper loss, the dielectric loss and the eddy current loss to obtain a winding which gives the lowest total loss and, consequently, the highest possible gain. The problem is further complicated by the question of winding width, since a wide winding will permit more turns to be close to the core, giving rise to a higher effective permeability but at the same time higher dielectric loss.

The choice, is, therefore, between a wide coil to give low copper loss, a narrow coil to give

It's NOW

EVERYDAY SCIENCE AND MECHANICS is the finest scientific-technical—mechanical—constructional magazine in the field. Up-to-the-minute with news flashes of scientific events. Dozens of constructional articles and many popular experiments. Ideas from which you can make things to sell.

10¢

A HOST OF INTERESTING SUBJECTS COVERED:

- Woodworking—
- Photography—
- Magic—
- Patents and Inventions—
- Book Reviews—
- Metal-working—
- Chemistry—
- Engineering—
- Microscopy—
- Electrical Experiments—
- Household Helps—
- Astronomy—
- Prize Contests—
- and other subjects.

OVER 150 ILLUSTRATIONS

10¢ the Get your copy today! copy On all newsstands



THE HIGH-GAIN ANTENNA STAGE

(Continued from page 91)

cans is either a compact lattice-wound coil or a four-layer bank. Both of these types give the highest possible efficiency for an air-core coil in very limited space. Where more room is available, coils of the two-layer bank or single-layer solenoid type are used.

The losses in coils are the factors which limit their gain and selectivity. In order to obtain a better idea for improving the performance of coils, we first must study the source of these losses in order to reduce or eliminate them. A reasonably clear picture of the problem may be obtained if we divide coil losses as follows:

- (1) Dielectric loss in the fabric insulation.
- (2) Eddy current losses in the conductors and shield.
- (3) Resistance loss within the conductor itself.

ANALYZING COIL LOSSES

Considerable progress has already been made in the improvement of coils in the first two respects.

(1) The dielectric loss in the fabric insulation has been reduced to a very low value by a suitable choice of winding in the case of a lattice-wound coil. In this coil the loss is minimized by increasing the number of crosses per turn. For example, a long-wave coil in which a high inductance is required and the dielectric loss is inherently low because of the low frequency, the wire traverses the winding only once per turn, whereas in high-quality coils for broadcast purposes, the number of crosses per turn may be as high as five or six. Dielectric losses have been still further reduced in certain applications where the additional cost of double-silk insulation can be justified over the cost of single-silk insulation. This increased thickness of installation results in lower capacity between turns with consequently lower losses.

(2) The eddy-current loss in the conductor has been reduced to a very low value by subdividing the conductor into many strands of wire, individually insulated by enamel and a sufficient number stranded together to obtain the proper amount of copper. (Litz wire). Eddy current losses in the shield have been reduced to a minimum by using shields of low resistance, either copper, aluminum or zinc, and by so proportioning the coil that its field is concentrated and as far away from the sides of the can as possible.

(3) Through many years of experimental work designing air-core coils as near to perfection as possible in a given can, engineers have looked for a means of reducing the copper losses. The most obvious method of reducing these losses would be to cut down, if possible, the total length of conductor in the coil necessary to obtain the required inductance. The simplest way of obtaining greater "inductance per turn" in a limited space is to employ, as a core, some medium having a permeability higher than that of air.

ADVANTAGES OF IRON CORES

Engineers have experimented for years, trying to adapt power transformer and A.F. transformer practice to R.F. coils. The use of iron cores in many varieties, laminated, powdered, fine iron wires, etc., has been tried, each variation adding something to our knowledge of the subject. Some of these attempts were not suc-

PIRATE STORIES

For August

A COMPLETE BOOK-LENGTH NOVEL "THE PEARL GANG"

A Story of the South Seas
By CAPTAIN RAABE

Also Selected Short Stories of the High Seas by your Favorite writers including Charles Kelly Sinclair, Wallace R. Bamber, and others. The Adventure Log, Captain Hardy's department for readers.

Combined with
HIGH-SEAS ADVENTURES

A GERNSBACK PUBLICATION
15c The Copy—On All Newsstands

Every SHORT-WAVE SET-BUILDER NEEDS THIS BOOK

SHORT WAVE COIL BOOK

Every experimenter who has ever tried to build a short wave set knows by experience, the difference between a good and a poor receiver is usually found in the short wave coils. Often you have to hunt through magazines, books, etc., to find the information you require. The present book has been gotten up to obviate these difficulties.

In this book you find every possible bit of information on coil winding. Only the most modern "dope" has been published. Illustrations galore, giving not only full instructions on how to wind coils, but dimensions, sizes of wire, curves, how to plot them, by means of which any coil for any particular short wave set can be figured in advance, as to number of turns, size of wire, spacing, etc. There has never been such data published in such easy accessible form as this.

Sent to you upon receipt of
25c
in coin or unused U.S. Postage Stamps.

RADIO PUBLICATIONS, 101C Hudson St., New York, N. Y.

Please Say That You Saw It in RADIO-CRAFT

low dielectric loss, a multiplicity of fine wire to give low eddy current loss in the conductor, a few strands of fairly heavy wire to give low cost and a large diameter can to give low shield loss. (Since all of the above factors must be considered in the choice of a design embodying this new core material, it is obvious that only those companies maintaining an adequate engineering staff can hope to be able to supply its customers with the latest and best information concerning the application of this material.)

Having designed an antenna coil having lower losses than any heretofore obtained in a unit of such small-space characteristics, care must be taken in the application of this antenna coil to a radio set in order to realize its full possibilities.

There are certain practices now in vogue in the lower price range of radio sets which cannot be countenanced in conjunction with ferrocarr antenna coils without limiting the gain possibilities of the units.

THE DEMANDS UPON ASSOCIATED COMPONENTS

First, the gang condenser in many cases is a serious offender. It must be so constructed that its losses are as low as possible. Those condensers employing bakelite for stator supports or for insulating washers under the trimmer screws will invariably be found to be worse than those employing hard rubber stator supports with ceramic washers under the trimmer screws.

In no case should a conventional shielded control-grid lead be used. If recourse must be had to shield the grid circuit, the partition-type of grid shield should be used if at all possible. If found not at all applicable, the next best shielding is large-diameter shielded loom (such as is often used for shielded lead-ins on automobile-radio antennas). Where the shielded loom is used, it is recommended that the control-grid lead be insulated with fabric rather than rubber because of the high losses in the rubber insulation.

To ignore the precautions outlined for the application of these high-quality coils to radio sets, may limit the performance of the iron-core coil so much that its performance will be so little better than air-core coils that the additional expense of the high-quality coil will not be justified and the user will be disappointed with the performance of the unit. Properly used, however, this type of coil will give excellent results.

Thus, gains from 25 to 40 can easily be realized in antenna coils; and gains just below the oscillation limit may be obtained in R.F. and I.F. stages, an average figure being about 50 per cent better than a good air core.

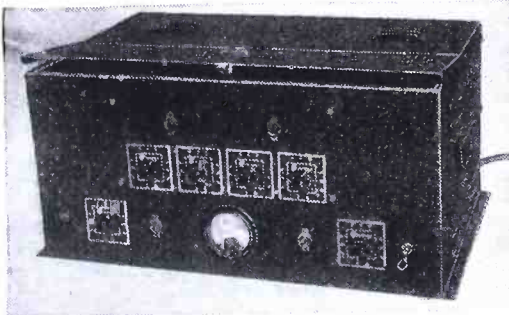

Above, the complete amplifier; below, the circuit (Fig. 1)

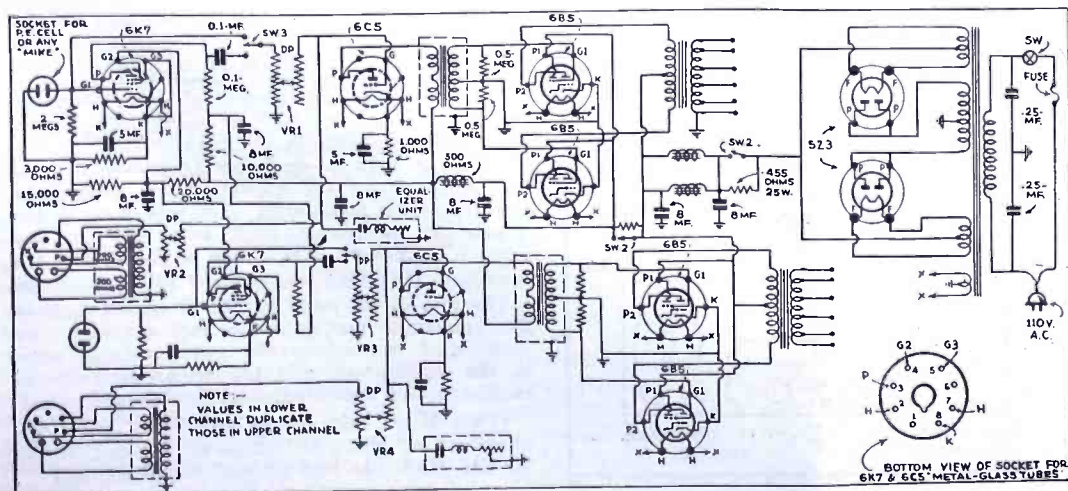

A BI-DIMENSION P.A. AND TELEVISION AMPLIFIER

(Continued from page 93)

powered by a common power supply. A close study of the schematic circuit will disclose the unusual and variable conditions under which the output tubes are operated.

When true high-fidelity performance is required (less than 2 per cent second harmonic distortion in the class A output circuit), switch Sw.2 is opened so as to introduce resistor R1, which causes a drop of 100 V. across its terminals. This automatically places 300 V. on all the plates of the 6B5 output tubes (with a subsequent production of 10 W. per channel; if the inputs of both channels are connected in parallel, a total of 20 W. is produced).

With the switch Sw.2 closed, resistor R1 is shunted out of the plate supply circuit and the full 400 V. of the power supply are applied to the output plates of the output tubes and 280 V. to the input plates of the output tubes. Under his operating condition, 20 W. of power per channel is produced. Here again, if the input circuits of both channels are paralleled, a total of 40 W. is produced with less than 5 per cent total second-harmonic distortion.

TWO-CHANNEL SYSTEM

Aside from the wide range (variable output) provided for by the two clear channels producing either 10 or 20 W. output per channel, the independent circuits add considerably to the reliability of the amplifier. For instance, under emergency conditions either one of the channels may be "idled" if any unusual condition develops in either channel during a program. This invaluable feature can only be really appreciated by those technicians who have experienced that heart-sinking sensation of an amplifier going "dead" during an important announcement.

BI-DIMENSIONAL APPLICATION

For the complete elimination of directional distortion and the true amplification in auditory perspective it is necessary to use four clear audio channels (or two, two-channel systems). (See *Radio-Craft* for January 1935, Page 407; and February 1935, Page 481, "Elements of Fourth Dimensional Sound Systems.")

Inasmuch as it rarely ever becomes necessary to amplify a moving sound source which shifts vertically, a two-channel amplifier is all that is required for the practical amplification of sound in auditory perspective. The system is set up as shown in Fig. 1. Each channel is connected to its own microphone and speaker. Care must be taken to place the reproducers in the same relative position as the microphones, but preferably in another room. If both master volume controls are attenuated to the same degree, a sound moving between both microphones will be reproduced between both speakers and will create the illusion of moving in exact synchronism with the original sound source.

An interesting application of a two dimensional sound system was given at a trade banquet wherein two orators, at opposite ends of the hall addressed each other, each one apparently filling the entire hall with his own voice. The realism of this two-channel system was effectively impressed upon the entire audience by virtue of two simple and comparative listening tests. First, both men spoke to each other through two paralleled microphones, both

(Continued on page 114)

Kendall Clough presents the
CATHODE-RAY SERVICER

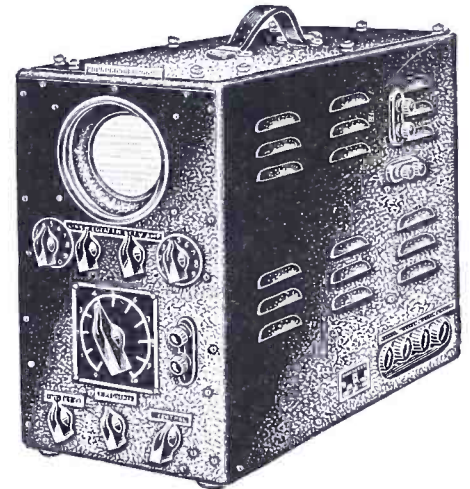

Radio receiver servicing moves another great step forward and CLOUGH-BRENGLE equipment is again the first to bring you proven features at lower cost.

See the selectivity curve of a set directly on a Cathode-ray tube screen calibrated directly in kilocycles. Adjust to desired sensitivity and selectivity. Observe receiver distortion and countless other tests.

Model OM Frequency Modulated R.F. Signal Generator has been specially designed for use with the oscillograph described below. Net price, complete with built-in frequency modulator, only \$47.85

Model CRA Cathode-ray Oscillograph with built-in amplifiers and linear sweep circuit, net price complete with three-inch Cathode-ray tube and all other tubes, only \$79.50

24-Page Cathode-Ray Booklet!

THE CLOUGH-BRENGLE CO.

1130 W. Austin Ave., Chicago, U.S.A.

Enclosed is 25c in stamps for which send me a copy of the new 24-page booklet on "Cathode-Ray Testing and Analysis," written by Kendall Clough.

Name

Address

SET BUILDERS

The new direct impedance coupling surpasses all other known forms of audio amplification in utter perfection of tone. Amazingly flat response from 16 to 16,000 cycles with separate rising accentuation from 70 to 16 cycles to compensate for losses in incoming signals. Practically all sources of distortion have been eliminated in this unique and exclusive circuit.

Radios incorporating it are no more difficult to build than conventional receivers, although they have a minimum of 12 tubes, 2 speakers and 3 power supplies. No special parts are needed. Net costs range from \$75 to \$500, complete.

Individually prepared plans and specifications are now available to set builders at a cost of 5% of the list price of the parts specified. This includes an advisory service which assures satisfactory completion. Please state price class in initial inquiry.

L. MITCHELL BARCUS

Experimental Research

Torrance, California

You WON'T BELIEVE YOUR EYES!

when you first see our sensational new LITTLE GIANT dry electrolytic! Smallest in capacity—yet it equals the big fellow in every scientific requirement. You thought SOLAR Star Midgets were something—wait till you meet the LITTLE GIANT!

Send for full details—QUICK!



Solar Mfg. Corp.

599-601 Broadway,
New York, U.S.A.

Solar Products Distributed by Leading Jobbers Everywhere

Please Say That You Saw It in RADIO-CRAFT

A. C. ELECTRICAL POWER

from a Windmill, from available Waterpower, from your Automobile, from your Motorcycle, from your Bicycle, Foot-pedals or Handcrank (for transportable Radio Transmitters, Strong Floodlights, Advertising Signs); do you want to operate AC Radio sets from 32 V. DC farm light systems; operate two generators in series to get 200 V. AC; obtain two phase and three phase AC, etc., etc.

Get Our
Westinghouse
200 Watt, 110 V. AC
Power Generator
Manufactured for U. S. Signal Corps

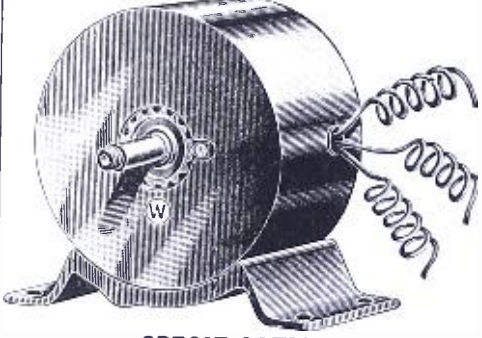

SPECIFICATIONS

HOUSING—Aluminum (Diameter 6 3/4 in. Length—5 1/4 in.). SHAFT—2 3/16 in. (driving end). Diameter 9/16 in. (the end is threaded for a distance of 3/4 in.). BASE—Cast Iron (Length—7 1/4 in. Height 1 9/16 in. Width 4 1/2 in.). OUTPUT—200 Watt 110 Volts AC (Speed 4500 R.P.M.). STATORS—Two pairs (two North and two South). ROTOR—12 tooth inductor. Built-in commutator. Rotor turns in ball bearings. 3/4 to 1 H.P. needed to run generator.

FREE With each generator, we supply a set of diagram-blue prints and instructions showing twenty-five different uses, technical information, electrical hook-ups and installing explanations. We also include a set of four replacement carbon brushes.

There Are Over 25 Applications Some of which are:

A.C. Dynamo lighting from eight to ten 20 Watt 110 Volt lamps. Short Wave Transmitter supplying 110 Volts AC for operating "Ham" transmitter. Operating 110 V. AC 60 Cycle Radio Receiver in DC districts. Motor Generator. Public Address Systems. Electric Sirens on motor boats, yachts, etc. Camp Lighting. Short Wave artificial "fever" apparatus. Television. Pelton Waterwheel for lighting or other purposes. Airplane: for lighting strong search lights or electric signs. Laboratory work, etc. etc. Generator, as described, including four replacement carbon brushes. Blue-print and instructions **\$7.90**

Send \$2.00 deposit balance C.O.D.
Shipping weight 18 lbs.

(Replacement carbon brushes bought separate \$1.50 per set of four. Set of instructions bought separate \$1.00.)

MONEY-BACK GUARANTEE.
DO NOT WRITE FOR CATALOG

WELLWORTH TRADING COMPANY
560 W. Washington Blvd. Chicago, Illinois

WELLWORTH TRADING COMPANY SW-8-35
560 W. Washington Blvd., Chicago, Ill.

Enclosed you will find my remittance of for which please send me
 Westinghouse Power Generator by Express collect
 or balance C.O.D.

Name
Address
City State

Big News for DEALERS — EXPERIMENTERS

We offer a real condenser buy to service men, experimenters and bargain hunters. Originally enclosed condensers manufactured by Potter. SPECIAL OFFER. 1MF., 25c ea.; 2MF., 30c ea.; 5MF., 50c ea. by name, in metal cases, tapped at 2 and 4MF., 75c. All mail orders promptly filled. All condensers guaranteed perfect. Cash in full for orders less than \$1.00. Larger orders, 25% cash, balance C.O.D., plus postage. Limited quantity.

A. H. Waage Company, 27 Warren St., New York, N. Y.

TRANSFORMERS

MADE TO ORDER OR REWOUND

Write for Prices!

CARMI TRANSFORMER WORKS
202-204 Staley St., Carmi, Ill.

A BI-DIMENSION P.A. AND TELEVISION AMPLIFIER

(Continued from page 113)

feeding into a common input and terminating in a group of dynamic reproducers situated in the center of the hall. It was apparent that whichever orator spoke, the sound always seemed to come from the same place (center of hall). Many guests experienced the heretofore unnoticed directional distortion wherein the original voice which was known to be originating in the north end of the hall, seemed to come (in amplified form) from the center of the hall. Furthermore phase interference between the original and amplified sound was predominant in a large area.

However, when the microphones were fed into their individual amplifier channels with separate overhead speakers at each end of the room, both the directional distortion and the phase interference completely disappeared, resulting in a naturalness of reproduction never before attained in any single-channel sound system!

The high-fidelity transformer coupling employed is an important feature of this amplifier, inasmuch as the coupling unit employs an entirely different coil and core structure than is used in standard transformers. The transformer is designed to provide a uniform frequency response within $\pm 1/2$ -db. from normal at 1,000 cycles to the upper (16,000 cycles) and lower (30 cycles) ends of the audio band. Additional features of this transformer, which are necessary for high-fidelity reproduction, include low leakage-inductance, negligible phase shift, and constant impedance at all frequencies. (Further, the use of one or more equalizers extends the response to within the requirements of operation at television frequencies.)

Although all of the transformers are self-shielded by virtue of their hum balancing windings, they are housed in an especially thick, high-permeability cast case to prevent the slightest pickup of any induced hum voltages. One of the secrets for the remarkable performance of these transformers lies in the selection of the core—which is composed of high-permeability alloy laminations, and which is operated at densities low enough to insure negligible third-harmonic amplitudes at the lowest impressed frequencies. (Additional data on "television"-fidelity transformers appear on page 92.—Ed.)

TELEVISION APPLICATION

The high-fidelity and high-gain characteristics of the amplifier, plus its dual-channel design feature makes it admirably suited for television applications, for one channel may be used in conjunction with a short-wave receiver for the amplification of television-image signals, while the second channel may be used with a separate receiver for the reception and amplification of the accompanying "sound." (A two-channel radio tuner makes an ideal adjunct for this amplifier when used for this purpose.)

How "auditory perspective" was obtained

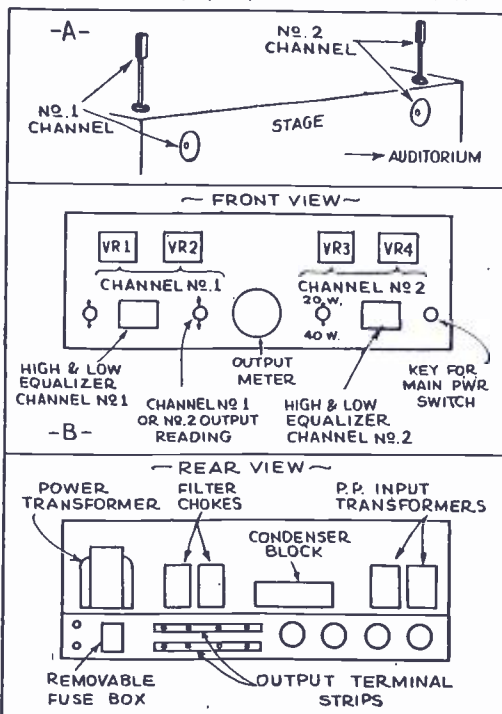

USES OF THE CATHODE-RAY OSCILLOSCOPE

(Continued from page 94)

quency-response curve may be obtained than with most types of voltage measuring instruments. The procedure to be followed is to apply the output of a variable-frequency A.F. oscillator to the input of the stage to be measured and to connect the output of this tube to the vertical plates of the oscilloscope either directly or through the amplifier. The A.F. oscillator is varied through the desired range and voltage measurements of the output taken at any desired number of points. These may be plotted as a response curve if desired.

Any method of measuring frequency response presupposes that the A.F. oscillator used will give uniform voltage output over the frequency range to be covered. The oscillator should be checked for uniformity of voltage output before response measurements are made. If the oscillator output is not uniform the stage output and oscillator output should both be measured at each frequency setting. The ratio between output and input will then indicate the gain of the stage at each frequency.

Where a high-gain amplifier is to be checked this procedure may prove inconvenient because of the large difference in magnitude between input and output voltage.

HUM MEASUREMENTS

The frequency and magnitude of hum at any point in a radio set or amplifier may be determined by applying the rectified voltage through a blocking condenser to the vertical deflection plates or through the amplifier, which already has a blocking condenser. The sweep should be adjusted to 60 cycles and locked with an external 60 cycle synchronizing pulse. Then 60 cycle hum will produce one wave on the screen; and 120 cycle hum, two waves. (The magnitude of the hum is indicated by the height of the waves.)

In attempting to eliminate hum from equipment the oscilloscope may be used to track the hum down to the particular component causing it. It is also very useful in tracing hum pick-up in transformers and wiring.

FEEDBACK AND REGENERATION

The oscilloscope may be very conveniently used to detect the presence of undesired oscillation and regeneration.

If the leads from the vertical plates, through the amplifier if desired, are placed across various points in the circuit, with no signal applied, only the straight, horizontal trace produced by the sweep should appear. The presence of oscillation is indicated by a block pattern or any widening of the sweep trace.

Regeneration, short of actual oscillation, may be checked by observing the output wave shape of the radio set when a modulated signal is fed to it. Regeneration usually causes serious distortion of the waveform and hence is readily apparent.

OSCILLATOR PERFORMANCE

A complete analysis of detector performance may be made including translation gain, linearity, distortion, voltage output, frequency response, and dynamic curves.

Oscillators may be checked for voltage output, frequency range, uniformity of output, ability to oscillate at high frequencies, etc.

CONNECTIONS TO OSCILLATOR

The two sets of plates of the frequency modulator are connected by short leads across the tuning capacity in the oscillator. For convenience it may be desirable to provide a pair of pin-jacks on the oscillator for connecting the frequency modulator. By this method the frequency modulator does not have to become a permanent part of the oscillator and the oscillator may still be used for other purposes.

The circuit on page 94 shows connections of the frequency modulator to the oscillator, the method of connecting the synchronizing pulse to the oscilloscope, and the connections of the oscillator and oscilloscope to the set under test.

(Part II of this article will cover other applications of the oscilloscope of interest to the Service Man, set builder and experimenter.)

Please Say That You Saw It in RADIO-CRAFT

THE FLUORESCENT SCREEN IN CATHODE-RAY TUBES

(Continued from page 95)

called "focusing"

The arrangement employed for controlling the intensity and focusing of the electron stream in the cathode-ray tube is shown in detail at Fig. 2B. The cathode, focusing electrode and anode considered together are often referred to as the electron gun because their function is to "shoot" the electrons along through the length of the tube.

THE FLUORESCENT SCREEN

When the electrons reach the anode they will have attained such high velocity due to its attraction that those which are in line with the tiny hole in its center will shoot right through it and continue on their way until they strike the inner surface of the far end of the tube.

The inner surface, S, of the flattened end of the tube is coated with a material that glows or "fluoresces" when electrons impinge upon it, thereby producing a bright spot of light. The material is usually bound on with pure water-glass. Several different materials, and combinations of them, are in current use for different colors of fluorescence. The most active material for producing visual light is zinc silicate (in the form of the powdered mineral *willamite*). This glows a bright yellow-green, to which the human eye is most responsive.

If the trace of the cathode-ray beam is to be photographed, for use in making oscillographs, calcium tungstate, which glows a bright blue color is better, since its light is about thirty times as active on a photographic plate as is that from zinc silicate. Cadmium tungstate may also be employed. (Mixtures of these substances are often used to produce a fluorescence fairly well suited for joint visual and photographic requirements.)

When the rapidly moving electrons strike the screen of fluorescent material, they are stopped suddenly and their impact energy produces light which appears as a spot of fluorescent glow.

Since the impact energy of the electrons varies as the square of their speed, or in other words, with the square of the voltage on the anode, the fluorescent-spot brilliancy increases rapidly as this voltage is increased. If the electron stream is focused carefully by adjusting the voltage on anode A1, the spot of light produced will be very small, but intense.

Because the size and intensity of the fluorescent spot of light produced on the screen are very important in the use of the cathode-ray tube, the intensity-control grid and the focusing anode are very important parts of the tube.

A spot that is too large will not give a sharp image; one that is too small may be difficult to see. A spot that is too dim may not photograph well or may not be seen with ease in a lighted room; a spot that is too intense will cause deterioration of the active material with which the screen is coated.

The latter is due to intense bombardment resulting at the point of impact of the electron stream on the coating of the screen. Just how intense is this bombardment and impact may be realized when it is known that the electron stream bombards the screen much as rapidly-fired machine-gun bullets would bombard a target, excepting that the machine-gun bullets would have a muzzle velocity of only about 2,000 miles per hour, whereas the electrons in an ordinary cathode-ray tube operated with 1,000 V. on the plate have a velocity of approximately 42 million miles per hour! Because of this intense bombardment of the screen, the beam should never be allowed to remain motionless, for if this occurs, the full impact energy of the electrons will be liberated and concentrated at the focused spot on the screen, causing the fluorescent material to disintegrate. A black spot will be observed in the screen after this occurs. (Tubes are now available in which this fault has been corrected, as described elsewhere in this issue by Allen B. Dumont.—Ed.)

Cathode-ray tubes are rated according to the diameter of the screen: a "3-in." tube is one with a screen 3 ins. in diameter; a "5-in." tube has a 5-in. screen, etc.

(Some interesting information on the use of cathode-ray tubes in servicing work appeared in the July, 1935 issue of *Radio-Craft*. Further data on the theory and operation of these interesting tubes will appear in forthcoming issues.—Ed.)

HOW TO MAKE A SIMPLIFIED "TREASURE" LOCATOR

(Continued from page 95)

interested in this subject. Gold is the metal most often used as a basis for discussion and this elusive metal has often been blamed for "detector" failures. Some writers claim the reason for this failure is because gold is the "deadest of metals." "Gold neither attracts nor repels" is another statement made to excuse the failure of locating devices.

These statements are misleading, and in fact, may be proven incorrect by the use of the unit described below. Also, according to the School of Mines at Tucson, Arizona, gold reacts to an electromagnetic field with greater force than any metal ore that this school tested!

Chemically, gold may or may not be the "deadest of metals" but it has a greater attraction for the lines of electromagnetic force than any "single" metal. Contrary to the usual statement, it is one of the "live-t" metals to detect. Gold causes a greater reaction on the instrument shown here, than any other metal; next in order being silver, copper, etc.

Space does not permit a full discussion of the many theories which may be proven in error by the use of this instrument. We must let the above statements suffice.

The instrument described is most sensitive to non-ferrous metals and for this reason is not a very good pipe finder.

The operation is very simple. Turn the filament switch on; adjust the meter pointer to the extreme right of the dial and then go to work. When metal is being detected, the meter pointer will move to the left and for non-metallic materials it will move to the right (increased reading).

CONSTRUCTION DETAILS

In construction, also, the details are simple. The photos show the positions of the parts and the circuit illustrates how simple it really is. The absence of shielding and choke coils is notable.

The coils (two are used, optionally) are the most difficult part of the construction. The small coil shown in the insert of the photo at the top of the page is a so-called pan-cake type, being spiral wound. This coil is made of No. 36 single cotton enamel covered wire. The resistance over-all is 250 ohms, the coil being tapped at the electrical center. It is then dipped in paraffin and protected between two wooden discs. The winding is 8-ins. in diameter.

The larger coil is 28 ins. in diameter and is wound flat, on a wooden hoop. It is wound with the same size wire as the small coil, and to a resistance of 300 ohms, with a tap at the electrical center. This coil is protected with a strip of heavy canvas over the wire. A strip of copper screening (mosquito netting) is then secured around the entire coil, leaving a space of about 1/2-in. at the place where the screening ends. In other words this screening forms an electrostatic shield over the coil and for this reason must not be permitted to form a completely closed "coil."

Both coils should be made in such way that they are completely waterproof.

This is necessary because the oro-scope can be operated in water. Probably the most satisfactory way of waterproofing the discs would be to first seal the edges with plastic wood or any similar compound and then varnish thoroughly.

LIST OF PARTS

- One 2 1/2 V. output meter (copper-oxide rectifier type), 2;
- One 5,000 ohm volume control, 8;
- One on-off switch for tube filament, 7;
- Two or three fixed condensers about .003-mf. and .300-mmf. (The inductance of the coil will determine the correct capacity), 3;
- One 3-conductor cable, 5-ft. long, shielded;
- One pound of No. 36 single cotton enamel covered copper wire;
- Two 22 1/2 V. "B" batteries, 4;
- One 4 1/2 V. "C" battery for tube "A" battery (use the 3 V. tap), 5;
- One 31-type tube, 1;
- One wooden box of suitable dimensions;
- Miscellaneous wooden parts for coils, wire for connections, etc.

(A 15-ohm resistor, not shown, will be required in the negative filament lead of tube V.)

SHOP COAT

free, with purchase of
**National Union
Radio Tubes**

YOUR NAME... that is your first name or nick-name embroidered over the pocket.

BIG POCKETS... look at the big extra roomy pockets, they're made with a slash at the side so you can get through to your clothing pockets too... without unsnapping the coat.

POWDERBLUE herringbone weave is the material which makes this coat unusually handsome... trimmed in dark blue.

FLY FRONT covers snaps so you can't scratch fine cabinets while you're working... no buttons to fall off but sturdy metal snaps fasten the coat down the front.



Service Dealers

It will pay you to learn all about the fine shop equipment National Union will give you. Send coupon!

National Union Radio Corporation,
570 Lexington Avenue, New York, N. Y.
Tell me how to get a shop coat and send information about free shop equipment. RC335

Name _____
Street _____
City _____ State _____

YOU CAN HAVE QUALITY AT A PRICE!

The complete assortment of condensers you need for your work now available at new low prices. The same high quality that has kept Cornell-Dubilier in the lead for 25 years—can be yours for less than ever before. See your jobber today, or write for latest catalog.

CORNELL-DUBILIER CORPORATION

4347 BRONX BOULEVARD
NEW YORK

neon

TATTELITE TESTER

"tells the tale"

Tests for blown fuses, condensers, or resistors, r.f. peaks and wave length, polarity, open circuits, live lines, defective spark plugs, etc. 100 uses—pocket size. With instructions—postpaid, a \$1.00 bill.

Send 10c for catalog of other Tattelites, instrument, Aircraft and High Voltage Littelfuses, Radio Fuses, Mtgs. etc.
Littelfuse Labs.
4523 Ravenswood, Chicago, Ill.



Please Say That You Saw It in RADIO-CRAFT

Just Out!

THESE TWO NEW BOOKS

10^C

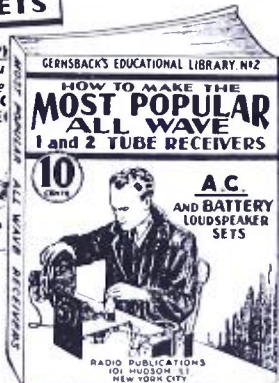
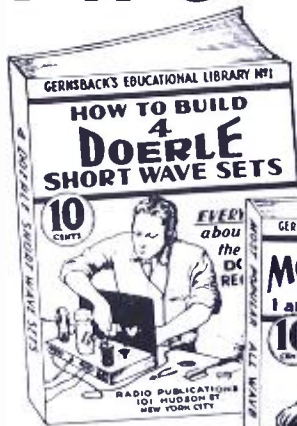

Each book contains 32 pages—and is well illustrated.

LITERALLY thousands of radio fans have built the famous DOERLE Short Wave Radio Receivers. So insistent has been the demand for these receivers, as well as construction details, that this book has been specially published.

HOW TO MAKE FOUR DOERLE SHORT WAVE SETS

Contains EVERYTHING that has ever been printed on these famous receivers. These are the famous sets that appeared in the following issues of SHORT WAVE CRAFT: "A 2-Tube Receiver that Reaches the 12,500 Mile Mark," by Walter C. Doerle (Dec., 1931-Jan., 1932). "A 3-Tube 'Signal Gripper,'" by Walter C. Doerle (November 1932). "Doerle '2-Tube' Adapted to A. C. Operation" (July 1933). "The Doerle 3-Tube 'Signal-Gripper' Electrified," (August 1933) and "The Doerle Goes 'Band-Spread'" (May, 1931).

Due to a special arrangement with SHORT WAVE CRAFT, we present a complete 32-page book with stiff covers, printed on an extra heavy grade of paper with numerous illustrations. Nothing has been left out. Not only are all the DOERLE sets in this book, but an excellent power pack if you wish to electrify any of the DOERLE sets, is also described.

HOW TO MAKE THE MOST POPULAR ALL-WAVE 1- and 2-TUBE RECEIVERS

There has been a continuous demand right along for a low-priced book for the radio experimenter, radio fan, radio Service Man, etc., who wishes to build 1- and 2-tube all-wave sets powerful enough to operate a loud-speaker. For the thousands of readers who wish to build such sets, this book has been especially published.

This book contains a number of excellent sets, some of which have appeared in past issues of RADIO-CRAFT. These sets are not toys but have been carefully engineered. They are not experiments. To mention only a few of the sets the following will give you an idea.

- The Megadyne 1-Tube Pentode Loudspeaker Set, by Hugo Gernsback.
- Electrifying The Megadyne.
- How To Make a 1-Tube Loud-speaker Set, by W. P. Chesney.
- How To Make a Simple 1-Tube All-Wave Electric Set, by W. Green.
- How To Build a Four-In-Two All-Wave Electric Set, by J. T. Bernsley, and others.

Not only are all of these sets described in this book, but it contains all of the illustrations, hookups, etc.—the book, in fact, contains everything. Nothing at all has been left out.

And believe it or not, each book contains over 15,000 words of new legible type. Each book is thoroughly modern and up-to-date. They are not just a reprint of what was printed before. All the latest improvements have been incorporated into the sets.

Remember, these books sell at the extraordinary low price of ten cents; you can not possibly go wrong in buying them. Despite its low cost, our usual guarantee goes with this book as well!

IF YOU DO NOT THINK THAT THIS BOOK IS WORTH THE MONEY ASKED FOR IT, RETURN IT WITHIN TWENTY-FOUR HOURS AND YOUR MONEY WILL BE INSTANTLY REFUNDED.

There has never been such a wealth of data published in a low-priced radio book of this type in the history of the radio publishing business.

Take advantage of the special offer we are making and use the coupon below.

RADIO PUBLICATIONS
103 Hudson Street
New York, N. Y.



RADIO PUBLICATIONS RC-8-35
103 Hudson Street
New York, N. Y.

- Please send immediately books checked:
- How to Make Four Doerle Short-Wave Sets.....10c
 - How to Make the Most Popular All-Wave 1- and 2-Tube Receivers.....10c
- I am enclosing; the price of each book is 10c. (Coin or U.S. Stamps acceptable.) Books are sent post-paid.

Name

Address

City..... State.....

A TEST UNIT FOR SOUND SYSTEMS

(Continued from page 93)

overload on the meter, hence it is shunted by a resistor of $\frac{1}{4}$ the meter resistance.

Then the total resistance of the meter and its parallel shunt is used in calculating the series multiplier. For the 5 V. range this is as follows: Referring to Fig. 1B, R_{se} is the series multiplier resistance. We know the current I for full-scale deflection is 1. ma. The meter resistance R_m is arbitrarily set, as before mentioned, at 600 ohms. Therefore, R_{sh} (the meter shunt) is 150 ohms. R_{sh} and R_m in parallel equal $600 \times 150 = 120$ ohms. Now by Ohm's Law,

$$R_{total} = \frac{E}{I} \text{ or } \frac{5}{.001} = 5,000 \text{ ohms.}$$

But from R_{total} must come the meter and shunt resistance of 120 ohms, leaving a value of 4,880 ohms for R_{se} . Other ranges are calculated in a similar manner.

A.C. VOLTAGES. As the meter is of the standard D'Arsonval type, a rectifier must be used when measuring A.C. voltages. The current will still remain at 1. ma. for full-scale deflection, with a sensitivity of 1,000 ohms per volt.

However, because the wave form of the rectified A.C. is such as to give average rather than r.m.s. values, the meter shunt resistor R_{sh} , Fig. 1C, will have to be increased by an amount sufficient to allow a rectified current of approximately 1.11×0.2 -ma. or 0.222-ma. to pass through the meter for full-scale deflection.

Considering the rectifier, it is an unfortunate fact that the rectifier resistance varies considerably with the amount of current passing. Hence, in order to have true readings we would have to resort to a special meter scale which would compensate for the rectifier resistance variations.

However, if we insert a condenser C (Fig. 1C) in series with the rectifier, and use its reactance for our multiplier, we will have a resultant current which is but slightly affected by the rectifier resistance, inasmuch as the drop across the resistance is in quadrature with that across the condenser. Hence we can retain our evenly-divided meter scale, as the current through the condenser is proportional to the voltage.

This negligible effect of the rectifier resistance variation is shown by the following calculations. The meter and its shunt have a resultant resistance of 132 ohms. The rectifier resistance at 0.5-ma. (for half scale deflection) is approximately 700 ohms, hence the total $R = 832$ ohms.

Considering the 5 V. A.C. range, we have $I = \frac{E}{Z}$, or $.001 = \frac{5}{Z}$, where Z is the imped-

ance of the circuit between the terminals. Therefore $Z = \frac{5}{.001}$ or 5,000 ohms. But $Z =$

$$\sqrt{R^2 + X_c^2}, \text{ hence } \sqrt{832^2 + X_c^2} = 5,000, \text{ or } 832^2 + X_c^2 = 25 \times 10^6 \text{ and } X_c^2 = 25 \times 10^6 - 832^2 = 25 \times 10^6 - 692,224 = 24,307,776, \text{ and } X_c = 4,935 \text{ ohms, from which } C = .537\text{-mf. for 60 cycle voltages.}$$

If however, the rectifier resistance changes from 700 ohms to say 1,100 ohms, as it might with a smaller current flowing, what would Z then be? Substituting values we have $Z = \sqrt{1,232^2 + X_c^2} = \sqrt{1,232^2 + 24,307,776} = \sqrt{1,517,824 + 24,307,776} = \sqrt{25,825,600} = 5,085$ ohms. The percentage of error introduced would be $\frac{85}{5,000} = 1.7$ per cent which is acceptable.

If a pure resistance were to be used in the above case for the multiplier, its value would be

$$R_t = \frac{5}{.001} = 5,000 \text{ ohms.}$$

$$R_{mult} = 5,000 - (132 + 700) = 5,000 - 832 = 4,168 \text{ ohms.}$$

Then if the rectifier resistance changed to 1,100 ohms with a decrease in current, our total circuit resistance would be

$$4,168 + 132 + 1,100 = 5,500 \text{ ohms, and the error would be } \frac{500}{5,000} \text{ or } 10 \text{ per cent. Hence the advantage of using the condenser multiplier is easily seen.}$$

A condenser is also used for the 25 V. range, and here, because of the higher reactance of the condenser, the rectifier resistance variation has even less effect. On the ranges above 25 V. straight resistance multipliers are used, inasmuch as the change in total resistance due to rectifier resistance variations is only a fraction of a per cent at the worst.

RESISTANCE MEASUREMENTS. For assisting in locating possible sources of trouble in sound equipment, it was considered necessary to include means for checking effective resistances ranging from a few ohms to many megs. If a D.C. source of voltage were used, it would necessitate external batteries to make the higher ranges available. However, by utilizing the meter in combination with the rectifier, it is found possible and feasible to supply the necessary voltage from an inbuilt transformer.

The method consists of applying a known voltage to the unknown resistor in series with the meter and rectifier, and noting the meter deflection. A source of 2 V. is used to measure all resistors up to .5-meg. Above this value the voltage is increased in order to produce a sufficient current through the higher resistance to give proper meter deflections.

Figure 1D shows the basic circuit. E_{ac} is the source of voltage, R_s a series resistance to balance the meter circuit against the unknown resistor, R_x . If R_x is 0, or the terminals are shorted, full-scale deflection will be had, indicating zero ohms. When there is any resistance at R_x , the meter deflection will be dependent upon its value, hence it can be calibrated directly in ohms.

CAPACITY MEASUREMENTS. Sound equipment also embodies condensers whose values are often desired. Again utilizing the source of A.C. voltage, and placing the unknown condenser in a series circuit, as shown in Fig. 1E, the meter deflections will be dependent upon the value of the capacity. For different ranges, a different E_{ac} is used so as to obtain satisfactory meter deflections for any condenser in that range.

For the higher values of capacity, that is, those larger than 0.1-mf. or so, the currents through the condenser become too large to be passed through the meter, hence the meter is shunted. Also, a tapped shunt is provided ahead of the rectifier so as not to overload this device. Figure 1F shows the basic circuit. Here, E_{ac} is limited to 10 V. so as not to damage high-capacity low-voltage electrolytic bypass condensers.

DECIBEL MEASUREMENTS. Facilities are provided for direct measurement of the power level in db. for a 500 ohm line up to plus 35 db. with respect to the accepted zero level of 6 milliwatts.

Essentially, the circuit is as shown in Fig. 1G, similar to an A.C. voltmeter circuit. Resistors R_1 and R_2 limit the current to acceptable values for satisfactory meter deflections. The meter, however, has a portion of its scale calibrated in decibels, obtained by calculating the meter current flowing when the test probes are across a 500 ohm line, with a given power level therein.

Arbitrarily choosing plus 35 db. as the top level we wish to measure (this being approximately 19 W.) what is the voltage across the line?

Taking the db. formula:

$$DB = 10 \log \frac{P_2}{P_1} \text{ we have } 35 = 10 \log \frac{P_2}{.006}$$

$$\log \frac{P_2}{.006} = 3.5$$

Referring to a logarithm table, we find the anti-log of 3.5 to be 3,162.3, hence $\frac{P_2}{.006} = 3,162.3$

$$\text{and } P_2 = 3,162.3 \times .006 \text{ or } 18.97 \text{ W.}$$

Then as $P = E^2$, $E = \sqrt{PZ}$, and $E = \sqrt{18.97 \times 500} = \sqrt{9,485} = 97.5 \text{ V.}$

Thus we determine $(R_1 + R_2)$ in Fig. 1G so as to limit our current to .001-A, through the meter and rectifier, (R_{sh} being shunted across the meter passing .0008-A.), as follows:

Resultant meter and R_{sh} resistance = 132 ohms.
 Rectifier resistance at .001 A. = 400 ohms.
 Therefore, $R = \frac{E}{I} = \frac{97.5}{.001} = 97,500$ ohms.

$$(R_1 + R_2) = 97,500 - (132 + 400) = 96,968 \text{ ohms.}$$

The value of R_2 is calculated similarly, by arbitrarily assuming a full-scale deflection for 20 db. in the 500 ohm line.

Then, with the circuit constants determined, the percentage of meter deflection for any db. level can be calculated by obtaining the voltage developed by that level, and determining what current this will produce through the meter.

Zero level of 6 milliwatts in a 500 ohm line is the accepted reference level. However, lines of various other impedances are often encountered, and the meter may also be used for ascertaining the level in these lines, by adding

Please Say That You Saw It in RADIO-CRAFT

or subtracting the number of decibels given by the relation $db. = 10 \log \frac{500}{Z_L}$

where Z_L is the impedance of the line under test. If Z_L is more than 500 ohms, the sign of the resultant number of db. will be negative, indicating a subtraction of that number from the meter reading. If Z_L is less than 500 ohms, the number of db. will be positive and should be added to the meter reading.

A chart showing actual line db. in terms of meter db. for various common line impedances, accompanies each tester.

TUBE-CIRCUIT ANALYSES. All amplifier tube circuits can be accurately checked by the point-to-point method. Any tube, including the new 8-prong metal tubes, or any tubes of less number of pins, is removed from its socket, and put into the proper socket on the panel. The analyzer plug on the end of its multi-conductor cable is placed into the vacant tube socket, thus bringing all the tube circuits to the tester, where the current flowing through any element, or the potential of that element to any other element, can be readily read. Also while the tube is in the tester, its condition can be instantly determined by means of the grid-shift method.

A FEW USES

Photoelectric cells may be checked in two different ways. First, by inserting the microammeter directly in one side of the cell circuit, the current flowing can be ascertained both with the cell dark and with full illumination. A good cell shows a considerable difference between the two readings, the exact amount depending upon the type and make of cell. Or, secondly, with a frequency reel running through the projector and the db. meter connected to the output line of the amplifier, exact db. differences between cells can be obtained by noting the output for equivalent portions of the film, all other variables and control settings being the same.

Battery charging and tungar rectifiers can be tested by inserting the D.C. ammeter in the top clip lead of the rectifier bulb.

By using the frequency reel which is furnished as a separate accessory to the tester, the overall frequency characteristic of the entire sound system in a projection booth can be obtained. The db. meter is connected to the output line, and the readings for each frequency are noted. The results show the variation in response for the different frequencies directly in db.

Using this same set-up, the image of the light slit in the optical system in the sound head can be accurately adjusted. As the frequency film is running through the projector the optical system is continuously adjusted to give maximum meter readings for each frequency, and is then locked in position after obtaining the maximum decibel reading on the highest frequency.

Also, notwithstanding the fact that this tester was designed primarily for sound equipment testing, it is admirably adapted to use by those radio Service Men who desire an instrument with the added features and ranges which it embodies.

Satisfactory arrangements are provided for checking sets embodying the new 8-prong metal tubes, with switches for properly connecting in the filaments, which are not always in the same place on tubes of different numbers of pins. Provisions have also been made for utilizing the center stud as a ninth contact if it ever becomes necessary, thus preventing obsolescence on this type of tube.

CONTROLS

By means of a rugged seven-position rotary switch, the meter is connected into its various circuits so as to be available for the several measuring functions explained above. The rectifier and the various shunts are automatically connected when this switch is rotated.

A 6-position range-selector switch, Fig. 2, makes it easy to instantly select any range of the meter for any of its functions except the db. ranges. The latter are controlled by a 2-position toggle switch.

A line adjusting switch is provided, connecting to the tapped primary of the inbuilt transformer which can be set for any line voltage from 98 to 125. Adjusting this is accomplished quite simply by putting the meter in the "Ohms" position and depressing the "Zero Ohms" switch. If the meter does not show zero, adjust the line adjusting switch until it does. Proper voltage

is then being delivered to the different circuits for the various measurements.

The meter is properly protected by a high-speed fuse, replaceable from the top of the panel; and the rectifier is protected against surges by a normally closed switch shorting it out until the operator is ready for the actual measuring.

Figure 3 illustrates the scale of the meter of tester.

A NON-MOTOR BOATING HIGH-GAIN AMPLIFIER

(Continued from page 92)

plifier free from motorboating effects. The use of series screen-grid and self-bias resistors in pentode amplifier circuits makes the characteristics of the amplifier less subject to possible variations in the tube characteristics and to variations in load- and bias-resistor values.

The circuit shown in Fig. 1 is a practical example of an amplifier designed according to the above mentioned principles. The values shown are suitable for obtaining a good response down to about 20 cycles per second.

A VERSATILE WIDE-RANGE CONDENSER TESTER

(Continued from page 94)

not necessary to press the button for continuity. Touching the probes together or across a short, will send the meter needle approximately full-scale.

Multi-meter. Ordinarily in a device of this nature the meter is confined to a use for which the device is assembled. Confidence has left the 1 ma. scale of the meter independent of the condenser tester, so that any range of multipliers or shunts can be installed at convenience to make a complete multi-meter without affecting the condenser tester. Six pin jacks are installed for this purpose and room is left for any future need of pin-jacks. This creates an additional value substantially equal to an additional 1 ma. meter, case and pin-jacks. Volt-meter multipliers are the popular 1,000 ohms-per-volt values.

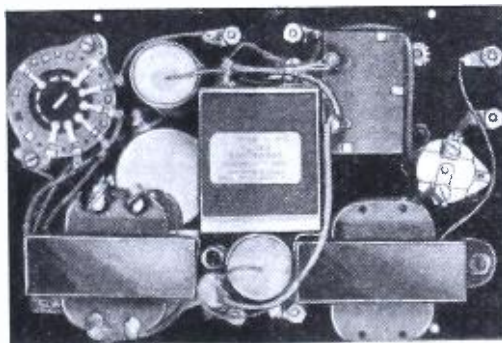

The interior of the tester.

INFORMATION BUREAU

(Continued from page 98)

audio amplifiers, including the maintenance and service of same?

(A) An excellent book on audio amplifiers is the "Public Address Installation and Service" volume No. 12 of the Radio-Craft Library series. We also suggest that you obtain a copy of volume No. 6 "Bringing Electric Sets up to Date" which contains much information on servicing amplifiers.

Q332. The circuit of the crystal set.

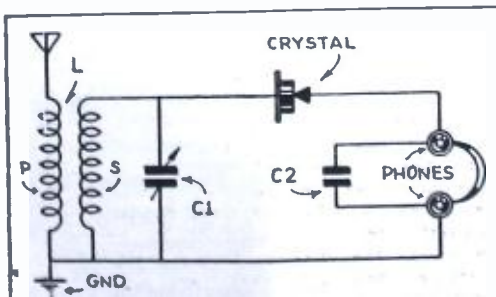

Please Say That You Saw It in RADIO-CRAFT

NEW - EXCLUSIVE SENSATIONAL

Accept... FREE FIVE DAY TRIAL OFFER



TOLEDO'S new speaker assembly with all aluminum baffle housing and adjustable wall mounting bracket

meets every indoor requirement of appearance, adaptability and performance. Improved baffle design greatly increases speaker efficiency and greatly reduces feed-back possibilities. Write for descriptive data on the TOLEDO line of laboratory built sound equipment. Get our prices and let us explain our liberal FREE FIVE DAY TRIAL offer!

- Portable Sound Systems • Electro-Dynamic Units • Carbon Microphones • Amplifiers • 4, 5 and 6 Ft. All Aluminum Natural-tone Trumpets • Field Exciters • Air Column Horns • Low and High Frequency Units For Wide Range Theatre Use

TOLEDO SOUND EQUIPMENT LABORATORIES
Formerly Bud Speaker Co.
1151 JACKSON STREET • TOLEDO, OHIO, U. S. A.



Kill Noises!

Use handy Aerovox Interference Filters. Plug between noise-producing appliance and line, or between radio set and line. Type shown used for extension cords, only \$2.25 list. Other type plugs into wall outlet plate, only \$1.75 list. Inexpensive. Efficient. Neat.

FREE DATA: Latest 1935 Catalog describes filters and complete line of condensers and resistors. Sample copy of Research Worker included.

AEROVOX CORPORATION
77 Washington St. :: Brooklyn, N. Y.

STOP GUESSING!
WHAT IS WRONG
WHAT TO CHARGE

Everywhere, progressive Service Men use a **CHUCKKER**, (repair-pricer and trouble-graph), to localize radio faults and estimate on the repair price. F. W. Tighe, Vancouver, Canada, says: "A really good Service Man does not guess. He uses a **CHUCKKER** and makes sure!" Mr. A. L., Phila., Pa., says: "Chuckker started me in the Service Business. Its repair-pricer makes my spare time more profitable than my weekly job!" Mr. M. K. B., St. Louis, Mo., says: "Using a **Chuckker** makes the difference between succeeding and failing. In the Service Business!" Tremendous acceptance justifies price reduction. Do not send \$1.00. Send just 50c NOW! (no stamps). We'll rush you a **CHUCKKER**, postpaid!

SEND 50c NOW!

PAUL G. FREED
(Publishing Division R)
5053 Baltimore Ave Philadelphia, Pa.

Most Amazing TYPEWRITER BARGAIN

**10 DAY
FREE TRIAL
OFFER** **EVER
OFFERED**



**NEW
REMINGTON
PORTABLE only** **10¢
A DAY**

FIRST TIME! Remington's new purchase plan now lets you buy a genuine latest model Remington Portable No. 5 direct from the factory for only 10¢ a day. Not used or rebuilt. Not incomplete. A beautiful brand new regulation Remington Portable. Standard 4-row keyboard, standard width carriage, margin release on keyboard, back spacer, automatic ribbon reverse; every essential feature found in standard typewriters.

With your machine we send you free a 19-page course in typewriting. Teaches touch system quickly, easily. Soon you dash off letters quicker than with pen and ink. You also get a handsome, sturdy carrying case free.

FREE Typewriting Course **BIG PRICE REDUCTION**



The amazing low price and easy terms now make it possible for you to buy this genuine complete Remington Portable for only 10¢ a day. But we cannot guarantee present prices long. Higher wage scales, rising cost of materials, everything points to higher prices. So we say, "Act now... while our liberal offer still holds good!"

FREE Carrying Case **You Don't Risk One Cent**



Try this typewriter in your home or office on our 10-day FREE TRIAL OFFER. Then, if you do not agree that it is the finest portable at any price, return it at our expense. You don't even risk shipping charges. Don't wait. Mail coupon now. It's the best chance you've ever had to own so complete a machine for so little money. So act NOW!

CLIP COUPON NOW

Remington Rand, Inc., Dept. 189-8
205 East 42nd St., New York City

Please tell me how I can buy a new Remington Portable typewriter for only 10¢ a day. Also enclose your new catalog.

Name _____
Address _____
City _____ State _____

POWERTONE PORTABLE RECEIVER



A compact 190 to 550 meter portable receiver weighing only 15 lbs. complete with installed batteries. Efficient super-het circuit provides maximum volume and extreme selectivity. Uses the new multi-purpose two volt tubes which include 1-34, 1-32, 1-1C6, and 1-33. An ideal receiver for use on picnics, boats, automobiles, outings, etc. Net price...complete with batteries **\$19.50**

TRY-MO RADIO CO. INC.
85 Cortlandt St., 179 Greenwich St., N.Y.C.

A.C. CURRENT-ANYWHERE! WITH Kato Light Plants



A Little Gas and a Kato AC plant enable you to operate AC radios, amplifiers, refrigerators and all other standard household appliances. Sizes 300 watts and up. Write for interesting descriptive literature.

KATO ENGINEERING CO. Mankato, Minn., U. S. A.
Mfg's of AC Generators and Converters for operating AC Radios on 32 and 110 volts DC.

THE LISTENING POST

(Continued from page 97)

thing, but he said "No," and switched on another circuit which showed up all of the main stations yet unlogged in bright red dots, like the eyes of some evil monster.

The floor of the room was covered with a rich carpet of deep blue, and in the center of the room in a massive cabinet, was the only console radio in the house. This beautiful hand-carved console had been especially made up for this room, and contained a unique arrangement of sound chambers, and speakers which diffused the sound all around the room with an equal intensity which made it impossible to tell from where the sound was issuing. A little panel in this cabinet also controlled the remote speakers in the various other parts of the house, which were all supplied with power from this one unit.

The big console receiver was now switched on and we were invited to sit down. Familiar stations, and favorite programs took on a new bearing. The musicians were actually in the room—music was all around us—laughing voices filled the room—or again the throb and pulse of a great pipe organ filled the room with its living vibrations. It was uncanny; realism carried to the nth degree.

Later we seated ourselves at the table and watched this radio wizard flick dials with an uncanny precision. A white finger of light leaped on the indicator; a blue light twinkled on the map near San Francisco. The station was KWU, at Dixon. He was calling Tokyo. "This is KWU at Dixon, California, calling Tokyo! Hello JVF! San Francisco calling! Are you hearing us Tokyo?" Whereupon our master DX'er moved to another receiver and almost at once a broken voice was heard saying, "Hello, San Francisco, this is Tokyo calling! This is JVF! Hello, San Francisco, we are getting you quite well. Shall we measure noise? In the meantime a blue dot of light had appeared at the far side of the huge map, denoting the other end of the circuit in far off Japan. Such is the wizardry of radio.

Spell bound we sat in this wonder room hearing a procession of nations go by, and a medley of tongues greeted our ears until we felt as if we were in a dream.

Swiftly the night wore on. "VK2ME" in distant Australia was at last tuned in, and we heard once again the cry of the kookaburra! As if a signal for the last trick in his bag of magic, our host touched a switch and the glass panel lights went out, and we were sitting in a room bathed with moon light. The map glowed dimly in front of us, and from the speakers again came the eerie cry of the kookaburra with a entirely new significance. The kookaburra quit, and somewhere in the house we heard a clock softly chiming THREE times. Almost at the same moment a hidden record device started to play "When Day is Done." It presently dawned upon us that this was the courteous way our host had of telling us that the show was over, and it was time for us to take our departure. Thus still walking in a dream of dials, maps, lights, and strange sounds it seemed, we took our leave of "Reception Refuge," and ended our never-to-be-forgotten visit to this modern day house of magic.

Australian Station Allocations On and After Sept. 1st, 1935

Freq.	Watts	Call	City, and State
550	10,000	2CR	Dubbo, New South Wales (Central Regional)
560	10,000	6WA	Wagin, South West Australia (South West Regional)
580	10,000	3WV	West Victoria (West Regional)
580	1,000	7ZL	Hobart, Tasmania
600	7,000	4QN	Townsville, Queensland (North Regional)
610	3,500	2FC	Sydney, N.S.W.
630	4,500	3AR	Melbourne
640	7,500	5CK	Crystal Brook, South Australia
670	7,500	2CO	Corowa, N.S.W.
690	3,500	6WF	Perth, West Australia
700	7,000	2NR	Northern Rivers, N.S.W. (Northern Rivers Regional)
720	2,000	6GF	Kalgoorlie, West Australia
730	2,000	5CL	Adelaide, South Australia
740	3,000	2BL	Sydney, N.S.W. Australia
750	7,000	7NT	Launceston, Tasmania (Northern Tasmania Regional)
770	3,500	3LO	Melbourne
800	2,500	4QG	Brisbane
820	50	7HO	Hobart, Tasmania
830	7,000	3GI	Gippsland, Sale, Victoria (Gippsland Regional)
850	500	5RM	Rennark, South Australia
870	1,000	2GB	Sydney, N.S.W.
880	500	6PR	Perth, West Australia
900	50	3MA	Mildura, Victoria
900		4WK	Warwick
910	2,000	4RK	Rockhampton, Queensland
930	600	3UZ	Melbourne

950	1,000	2UE	Sydney, N.S.W.
960	300	5DN	Adelaide, South Australia
970	200	3BO	Bendigo, Victoria
980	30	4AY	Ayr, Queensland
980	50	6BY	Bunbury, West Aust. Central, N.S.W.
990			
1,000	300	4GR	Toowoomba
1,010	300	3HA	Hamilton, Victoria
1,020	1,000	2KY	Sydney, N.S.W.
1,030	600	3DB	Melbourne
1,040	2,000	5PI	Crystal Brook, S. Aust.
1,050	500	2CA	Canberra
1,060	25	3YB	Mobile station in Victoria
1,060	50	4MB	Maryborough
1,070		2KB	Katoomba
1,070	500	6AM	Norham, West Australia
1,080	50	3SH	Swan Hill
1,100	300	7LA	Launceston, Tasmania
1,110	750	2UW	Sydney, N.S.W.
1,120	1,000	4BC	Brisbane, Queensland
1,130	300	6ML	Perth, West Australia
1,140	500	2HD	Newcastle, N.S.W.
1,150	50	2WG	Wagga, N.S.W.
1,160	100	4MK	Mackay, Queensland
1,170	200	4TO	Townsville, Queensland
1,180	600	3KZ	Melbourne, Vict.
1,190	1,000	2CH	Sydney, N.S.W.
1,200	300	5KA	Adelaide, South Australia
1,210	50	2GF	Grafton, N.S.W.
1,210	500	6KG	Kalgoorlie, West Aust. South Queensland
1,220			
1,230	2,000	2NC	Newcastle, N.S.W.
1,240	250	3TR	Sale, Victoria
1,260	60	3WR	Shepparton, Victoria
1,270	1,000	2SM	Sydney, N.S.W.
1,280	600	3AW	Melbourne, Victoria
1,290	300	4BK	Brisbane, Queensland
1,300		2TM	Tamworth, N.S.W.
1,310	300	5AD	Adelaide, South Australia
1,320	50	3BA	Ballarat, Vict.
1,330	50	4RO	Rockhampton, Queensland
1,340	50	2XN	Lismore, N.S.W.
1,350	50	3GL	Geelong, Victoria
1,360	100	2BH	Broken Hill, N.S.W.
1,360		4PM	Port Moresby, Queensland
1,360		7BU	Burnie
1,370	50	3HS	Horsham, Victoria
1,380	600	4BH	Brisbane, Queensland
1,390	100	2GN	Goulburn, N.S.W.
1,400	300	6IX	Perth, West Australia
1,410	500	2KO	Newcastle, N.S.W.
1,420		3XY	Melbourne, Vict.
1,430	50	2WL	Wellington, N.S.W.
1,440	50	2MO	Gunnedah, N.S.W.
1,450	50	5MU	Murray Bridge, South Australia
1,460	300	7UV	Ulverstone, Tasmania
1,470			—, Beqa
1,470		4CA	Cairns, Queensland
1,480	50	2AY	Albury, N.S.W.
1,490			South, N.S.W.
1,500			Hobart, Tasmania
1,500	50	3AK	Melbourne, Vict.

NOTE: Those channels about which no information is given are held open by the Government for future stations planned for the towns named.

OUR HIGH-FREQUENCY HIGHLIGHTS

Twenty-meter foreign amateurs have never been more plentiful than this season. Nearly any evening before dark several European amateurs can be received throughout the east, and central states. Those most consistently received are—G5ML, G5BJ, G6XR, of Gt. Britain; ON4AC, and ON4AU of Belgium; CT1BY of Portugal; EA4AO of Spain; LA1G of Norway; HB9AQ of Switzerland; D4CB of Germany; U2AI of U.S.S.R.; and SU1FS of Egypt. Amateurs in the West Indies which are well received include VP6YB in Barbados; VP5PA (Portable in Haiti) HI9I, and HI7G in Santo Domingo; those in Central America most commonly heard are HP1A of Panama; YN1OP of Nicaragua; TI2FG, and TI3WD of Costa Rica. Those in South America most commonly heard are LU1PB, LU8DR, LU6AP of Argentina; CE1BC of Chile; HC1FG, and HC1JW of Ecuador; CX2AM of Uruguay; and OAX4B of Peru. The British Guiana station VP3BG has also been heard well. An Australian amateur VK2EP has been reported in California lately coming in around 11:30 p.m. P.S.T.

One of the best-received German transmissions in North America is that of DJD, Zeesen 25.51 meters daily from 5:05 to 10:30 p.m. E.S.T. This transmission which is beamed on North America comes in with tremendous volume. Station DJC continues to broadcast the latter part of this transmission from 9:30 to 10:30 p.m. E.S.T. daily, although this transmission is rarely heard on account of noise, and weak signals.

R. C. Messer of S. Portland, Maine, reports that HC2AT, Guayaquil, Ecuador, is on daily from 8:00 to 10:00 p.m. E.S.T. on 35.7 meters according to their verification. They make announcements in English, and state they are owned by "The American Trading Co." of Ecuador. They plan to increase their power soon.

VPD, Suva, Fiji Islands on 13.07 mcs. after using the call of VP1A for a while have now returned to the former call of VPD, but usually just announce as "Radio Suva." This station may be heard from 12:30-1:30 a.m. E.S.T. daily except Sunday.

Station ZBW, the new short-wave transmitter in Hong Kong, China, first mentioned in last

Please Say That You Saw It in RADIO-CRAFT

month's RADIO-CRAFT has been heard on the Pacific coast irregularly from 3:00 to 6:00 a.m. P.S.T., and on an announced frequency of 8,750 kc. No call is used but the station may be addressed as "Short-wave Station ZBW, Secretary of the Broadcasting Committee, Hong Kong, China."

Radio Coloniale, short-wave station of France will soon blossom forth as the world's most powerful short-wave station with a new transmitter of 100,000 W. The new transmitter is being finished at Villejust near Paris, France. The French government has allotted the new station channels on the 16, 19, 25, 31 and 49 meter bands.

VK3ME of Melbourne, Australia, 9.51mcs. has been broadcasting lately on Wednesday, Thursday, Friday, and Saturday from 5:00 to 7:00 a.m., E.S.T., and according to the station officials may soon be on a daily schedule (except Sunday).

The Spanish Ambassador in Washington, D.C., announces that EAQ, Madrid, Spain, is now putting on a program each day dedicated especially to the United States, at approximately 6:30 p.m., E.S.T.

W2XHI, the long-awaited super-power station to relay WOR, of Newark, New Jersey, has been delayed again and now probably will not take the air before the first of November.

After some weeks of tests on various wavelengths, the E.I.A.R. of Rome, Italy, decided to definitely transmit the "American Hour from Rome" on their 31.13 meter channel. The "American Hour from Rome" takes place from 6:00 to 7:30 p.m. on Monday, Wednesday, and Friday nights. Other transmissions being broadcast from 2RO, Rome, at the time of writing are:

- Daily to Japan—11.8mcs. from 9:15 to 10:15 a.m., E.S.T.
- Mon., Wed., Fri. to N.A.—9.64 from 6:00 to 7:30 p.m., E.S.T.
- Tues., Thurs., Sat. to S.A.—9.64 from 7:45 to 9:15 p.m., E.S.T.
- Daily, Omni-directional—9.64 from 2:30 to 5:00 p.m., E.S.T.
- Daily, to Mediterranean Basin—9.64 from 8:15 to 9:00 a.m., E.S.T.

ORSMA MEMBERS FORUM

(Continued from page 99)

with a .002-mf. condenser having a working voltage of 600 V. The condenser originally in the set had a working voltage of 400 V. The higher voltage condenser made the set OK.

ARTHUR W. SPERLING,
Clifton, N.J.

SOME HINTS FOR ORSMA MEMBERS

RADIO-CRAFT, ORSMA Dept.:

As a member of the ORSMA, I have a few service hints I would like to submit to the Members' Forum.

Don't junk old Brunswick Panatropes because they have no resale value. These Panatropes contain two amplifiers with the power unit built in, having two 81 rectifiers and a 10 type tube. One of the amplifiers, the 945 is built into the set proper and the 947 is in an external cabinet with the speaker. These amplifiers are driven by a type 99 tube in the R.F. section but by connecting the phono. pickup directly to the input of the 945 and the output of this to the input of the 947, you have an amplifier that can be heard for several good-size blocks.

The RCA-Victor battery models 241 and 242B give the most trouble with output and input transformers burning out. In the 242B model the input transformer is located directly above a terminal board under the chassis and it is rather difficult to unsolder the old transformer leads and thread the new ones through the hole in the chassis and then fish them out from between the terminal board and chassis. The following few steps will quickly conclude a neat job: take a pair of long-nose pliers and pull the old leads from the transformer; then, mount the new transformer in its place and soldering the new leads to the old ones; finally, tape them and pull them through the chassis.

Some time ago a 5-tube Echophone model S3 was brought into the shop for repair and the set was connected up. When the tubes heated up enough to play, it gave a mighty bloop and that was all until it was shut off and let cool.

An analyzer plug was inserted in the detector socket and the set was turned on again and when the tubes began to heat up the voltage rose to normal until the set was on the point of playing and then it let out a squawk again and the voltage on the plate and screen-grid fell off completely. A check on the resistors in these three circuits disclosed that when they were heated, they were several million ohms above their rated values. A replacement of these resistors made the set play normally.

CLAUD EDWARDS,
New Holland, Ga.

INFORMATION BUREAU P. A. QUESTIONS & ANSWERS

(Continued from page 98)

output power is expressed as a logarithmic ratio to the power level of the amplifier. The formula for the determination of the hum level in db. below the maximum power output is:

$$\text{db.} = 10 \times \text{Log } 10 \frac{P_o}{H_o}$$

Where db. is the hum level below maximum output level,

P_o is the maximum power output in watts, and H_o is the hum level output in watts.

(See the graphs and detailed data in the article, "Valuable 'Decibel' Data," in the preceding July issue.)

STUDIO TECHNIQUE

(10) Rudolph Ackerman, Brooklyn, New York.

(Q.) What is meant by the "live and dead end" studio pickup technique?

(A.) This phrase refers to a carefully-designed studio, Fig. Q. 10, furnished with sliding sound absorbing panels which are arranged to prevent sound reflections at the "dead" end of the studio from interfering with the direct waves being picked up by the microphone. The "live" end of the studio is finished with a hard, sound-reflecting surface which adds a distinct brilliance to the program, conducted in the "live" end and picked up by the microphone located in the "dead" end. By sliding the panels, the acoustic conditions of the studio may be altered to meet the requirements for any particular program.

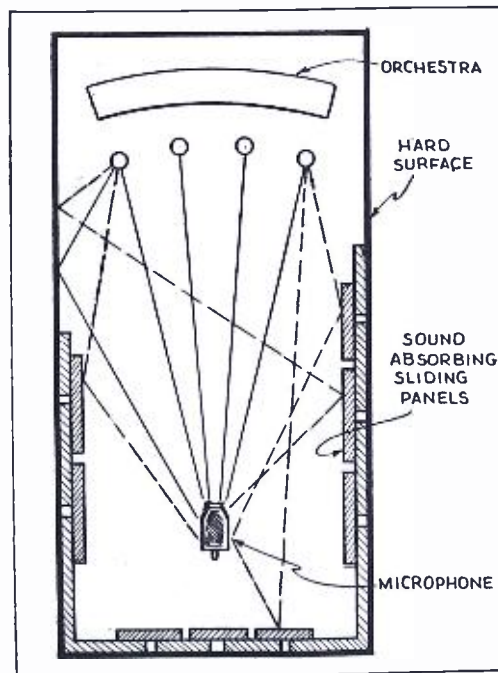

Fig. Q. 10—Dotted lines are reflected waves; solid lines are direct waves reaching the microphone.

OPERATING NOTES

(Continued from page 96)

cut from a mica sheet in a discarded flatiron element.)

I could attribute the trouble to only one thing. That was, that while the set was being moved, some of the electrolyte from the wet condensers might have spilled on the trimmers.

ALFRED F. SPADONI

Please Say That You Saw It in RADIO-CRAFT

NEW REMOTE CONTROL AUTO AMPLIFIER

A 6 VOLT JOB CONVERTIBLE TO 110 VOLT USE

Operates Directly From Crystal Mike

Here's a Lafayette P.A. unit that is a first rate investment! Not only may it be used for outside work in connection with a car during the summer months, but it may also be used on 110V., A.C. (with a separate little power pack) without changing a single wire! Thus this compact, combination amplifier may be used effectively in any location. Features include remote controlled volume control; rated output 12 watts, into 500 ohm line, at 5% harmonic content; peak 18 watts; gain of 104 db.; power consumption of 14 amps. from 6v. battery.

MODEL SC-135A—Lafayette Auto Amplifier, with remote control unit, less tubes. **\$39.50**

MODEL SC-361-P—Special A.C. Power Pack for model 135-A with tube. **\$8.25**

FREE! Our great 128 page Catalog No. 57 with over 30 pages devoted to P. A. Amplifiers and accessories. The most varied and complete line of P. A. in America—all at lowest WHOLESALE prices! Address Dept. C-85.

WHOLESALE RADIO SERVICE CO.
Main Office and Warehouse:
100 SIXTH AVENUE - NEW YORK, N.Y.
ATLANTA, GA., 430 Peachtree St., N.W.
NEWARK, N.J., 219 Central Ave.
BRONX, N.Y., 542 E. Fordham Rd.

REPLACEMENTS FOR ALL REGULATORS OR BALLAST TUBES

Standardize on Amperite Regulators. There's an Amperite for every current or voltage problem in any set.

Write for CHART CV.

AMPERITE

CURRENT AND VOLTAGE REGULATORS

AMPERITE Co. 561 BROADWAY NEW YORK

BUY THESE Great Books!

Ghirardi's MODERN RADIO SERVICING
Ghirardi and Freed's RADIO FIELD SERVICE DATA

Send for FREE CIRCULAR today!
RADIO & TECHNICAL PUBL. CO.
45 Astor Place, Dept. RC-8, New York City

RAYTHEON

TRADE MARK

4-PILLAR RADIO TUBES

Write for FREE 1935 Tube Chart
RAYTHEON PRODUCTION CORP., Dept. E-8,
30 East 42nd St., New York, N.Y.

Now— Test the 8-PRONG METAL TUBES

New, Improved, Lower-Priced
ANALYZER UNIT
Dependable Model 501

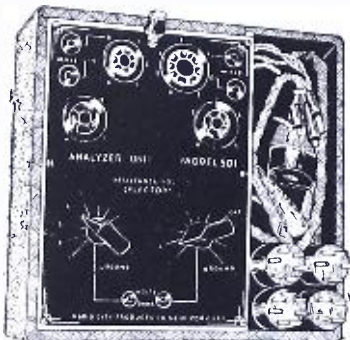

\$8.85

**COMPLETE,
READY TO
OPERATE**
KIT FORM,
COMPLETE
\$6.95

JUST connect the new "DEPENDABLE" Model 501 ANALYZER UNIT to the meter of your obsolete analyzer—or better still, to the new "DEPENDABLE" 403-A MULTITESTER, and you will have a modern and efficient analyzer without expensive investment. Model 501 is the only Analyzer Unit combining all of the following features:—(1) Equipped with 6 ft. 10-wire analyzer cable, 5 "Sure Pull Out" adapters, separate chassis-ground wire with insulated lamp. (2) Free Reference Point testing between any two elements, including chassis or ground. (3) Instantaneous selector switches—no reference charts—no fussing with jacks and prods. (4) Current measurements through automatic series jacks. (5) Will not become obsolete.

Compact, light, handsome. Includes Adapters, Leads for Current Testing. Open face, with tool and adapter compartment.

Dependable TUBE CHECKER Improved Model 304

\$19.95

**COMPLETE,
READY TO
OPERATE**

Kit Form,
Complete,
\$15.65



Will Test Over
160 Different Type
Tubes, Including New 8-
Prong Metal Tubes

Accuracy is essential in tube testers. Adaptability for all present and future needs is valuable. Convenience and good looks are desirable. But high price isn't necessary.

The new Radio City "DEPENDABLE" Tube Tester provides all of these features at the lowest cost. And their reputation with service men and dealers is unsurpassed. Complete units, ready to operate, or money-saving kits.

The only tube tester showing leakages above one-million ohms. Neon-light indicator. "Good-Bad" meter. Tests all today's tubes and provides for 50% increase. One-button operation. Etched metal panel. Leatherette case. Counter and portable models.

**We Issue
No Catalog** All orders are F.O.B. New York. Terms: A deposit of 20% is required with every order. Balance may be paid on delivery. DEDUCT 2% IF FULL AMOUNT IS SENT.

GRENPARK COMPANY
101 Hudson St. Dept. RC New York, N. Y.

PRACTICAL METHODS OF SERVICING "NOISE"

(Continued from page 97)

ent power circuits, and listening in to observe if the interference continues or not. Of course, among the interference problems will be found such things as defective fuses, imperfect transformers, broken distribution on power line, broken insulation inside the transformer, etc.

Here is a point of importance for people who live near electrified railways or trolley tracks. In these locations "electrolysis" takes place. Electrolysis may be defined as the quantity of electrical energy which, upon leaving a conductor whose unity is broken, creeps into the earth and attacks other compounds with a tendency to form a current path of its own. In this path, the elements are resolved, due to a reaction of potential difference, during the migratory period necessary for completion of the circuit. While on this path, an enormous amount of electrical interference it created, which forms itself into two components, upper- and lower-strata electrolysis. Therefore, the power company should make sure that all bonds are intact. Figure 2 shows a section of track and a bond.

Many instances of interference caused by poorly connected bonds have been encountered, aided by high resistance of the ground (poor conductivity). Interference is sometimes carried for several miles, through a swath of 200 to 300 ft. on either side of the break.

Electrolysis also destroys metals which are close by, such as gas pipes and water mains.

However, something must be said in favor of the power companies. With interference coming from such things as primary fuse contacts, primary grounds and contacts, defective street lighting circuits, defective insulation, and primaries brushing against trees, no power company can check up at once on all these probabilities. (Our experience has been that they are very accommodating, and do their best to cooperate at all times with any requests for interference trouble-shooting.)

Figure 3 shows a demand-meter chart. Figure 4 demonstrates a broken buzz, as recorded on the meter tape. By examining this, and listening to the noise, one may learn to recognize the actual type of interference created, for no two types of interference are of exactly the same characteristics. According to the laws of line transmission, an input electrical wave of variable characteristic and frequency forms an elongated path, whose projection of electromagnetic function is always convergent to the path of the conductor. Therefore, one source of interference starting from one point, and another interference starting from another point on the same conductor, form two anodic waves whose intensity will be equal to the square of the distance of line transmission.

On closer observation, these electric waves (which may be termed interference) have a common origin in the form of an oscillatory circuit of definite characteristics. The discharge of an electric spark, taking place between the gap, is of the "Hertzian" type, regardless of the length of current which must oscillate to give interference. Unlike etherial waves, this type of energy is compensated within that definite path, on the order of a parasitic wave, which tends to oscillate in sections. Therefore, this produces a symmetrical system which is not a geometrical progression, nor a radio radiation of the Hertzian type.

The writer contends that a large percentage of electrical interference is brought into the home not by the power company, but by reason of the inefficient workmanship of the electrician who wired the building.

On the other side of the meter which comes into the home, there should be a filter system, consisting of two choke coils (one in either leg of the lighting circuit), of 50 to 60 turns of wire, and sufficiently large to meet the current demands of the home. To the low-potential ends of the coils should be connected two condensers in series, each having a capacity of 1 to 2 mf., and with the center-tap grounded. On the other side of the chokes, two additional condensers of similar type should be connected in series, and the center-tap grounded like the other. In this

manner, a filter is formed which will kill 80 per cent of the interference created inside a home, produced by such implements as vacuum cleaners, heating pads, electric irons, curling irons, motors, violet ray health lamps, X-rays and the like. Although the circuit of this type of filter system is generally known, it is reproduced for convenience in Figs. 5A and B.

We have correlated the records of demand-meter charts made in three different sections of the city of Marietta, Ohio; they were chosen to show the amount of fluctuation in the power line system. They show inefficiency insofar as distribution of current is concerned, as the fluctuation varies from 90 to 130 V. This shows very poor stabilization and poor service rendered to the consumer. The company desires to permit an overlap of not more than 5 V. above or below the level of 110 V. However, since the voltage is irregular, it is no wonder that radio sets and other household devices become defective.

It is to be sincerely hoped that the radio set of the future will carry a line voltmeter, and a voltage regulator or some efficient type of automatic voltage control so that at all times the amount of electrical input to the set may be kept at the correct potential.

RAYTHEON IMPROVED 2A3 TUBE

A new, improved type 2A3 tube developed by Raytheon possesses double the plate area of the older, more conventional design. This unusually large radiating surface which is a feature of the design provides ample cooling, a factor not wholly cared for in the former type.

The advantages of cooler operation are obvious to engineers: cooler elements mean long life, capacity to run for long periods at rated output, and freedom from grid emission.

This new dual triode with two sets of elements connected internally in parallel will be of special interest to engineers and manufacturers now that the inherent cooling problem of the older 2A3 type has been solved.

AIR CONDITIONING is America's Next Great Industry

THE idea of electricians, radio service men and other mechanically inclined men servicing Air Conditioning and Refrigeration Units is self-evident and the thought has occurred to some untold thousands ever since air conditioning equipment has been installed in public auditoriums, theatres, studios, department stores, office buildings and manufacturing plants. The tremendously broad possibilities in this new industry are bound to give employment and success to men far-sighted enough to see its advancement and development.

Well-known Engineer Edits Manual

THE OFFICIAL AIR CONDITIONING SERVICE MANUAL is edited by L. K. Wright, an expert and a leading authority on air conditioning and refrigeration. In this Air Conditioning Service Manual nearly every page is illustrated; every modern installation and individual part carefully explained; diagrams furnished of all known equipment; special care given to the servicing and installation end. The tools needed are illustrated and explained; there are plenty of charts and page after page of service data.

CONTENTS IN BRIEF

History of Air Conditioning; Fundamental Laws; Methods of Refrigeration; Ejector System of Refrigeration; Compression System of Refrigeration; Refrigerants; Lubricating Oils; Liquid Throttle Devices; Servicing Expansion and Float Valves; Servicing Refrigerating Systems; Control Devices; Thermodynamics of Air Conditioning; Weather in the United States; The Field of Air Conditioning; Insulating Materials; Heat Transmission Through Walls; Complete Air Conditioning Systems; Estimating Requirements for the Home, Small Store, Restaurant; Layout of Duct Systems; Starting Up a System; Operating and Servicing Air Conditioning Systems; Air Filtration; Ventilating and Noise Eliminating Devices; Portable Electric Humidifiers and Room Coolers; Automatic Humidifiers; Air Conditioning Units for Radiator Systems and Warm Air Systems; Central Conditioning Units, etc.



**352 Pages
600 Illustrations**

9x12 Inches

Flexible, Loose-Leaf
Leatherette Cover

\$5.00 A COPY

(Send remittance by check, money order or unused U.S. Stamps. Register letter if it contains stamps or currency.)

GERNSBACK PUBLICATIONS, INC.
99R Hudson Street New York, N. Y.

Please Say That You Saw It in RADIO-CRAFT

BROADCASTING 25 YEARS AGO

The early history of broadcasting contains many intriguing stories such as this one which we have recovered from "the limbo of forgotten facts."

LEON L. ADELMAN

A HITHERTO unwritten chapter in the romantic history of radio broadcasting, dealing with the transmission of actual programs a quarter of a century ago from a Seattle, Washington, "wireless station", was revealed recently, exclusively to *Radio-Craft*, by William Dubilier, distinguished American radio inventor.

Only 22 years old at the time, Dubilier had gone to Seattle during the summer of 1910 to install a radio station for the now defunct Commercial Wireless Telephone Manufacturing Company. The apparatus was of the "singing arc" type and operated on a wavelength of 4,000 meters. For an antenna, Dubilier used a huge umbrella shaped affair containing about 40,000 feet of wire, suspended from a wooden tower 320 ft. high. The bottom of the umbrella embraced a circle on the ground almost a quarter of a mile in diameter.

Those were the lawless days of radio, when station owners chose their own wavelength and power and invented any call letters that struck their fancy. The station with the loudest spark got its messages through, and "key punchers" were in great demand. Therefore, when Dubilier's boyish voice broke through the clatter of code signals the astonished operators on the busy coastwise boats could hardly believe their ears, and indeed people to whom they related their experiences looked at them askance.

It was the discovery of a notarized affidavit from one such operator, accidentally found by Mr. Dubilier a few days ago among some old papers, that recalled the whole almost-forgotten episode to him.

"State of Washington, County of King", reads the yellow, brittle document. "J. H. MacDonald, being first duly sworn, upon oath deposes and says: That he is one of the wireless telegraph operators in the employ of the Canadian government at Point Grey station, which is equipped with an aerial about 225 ft.

in height, of the umbrella type, consisting of eight wires with silicon detector and standard receiving set of the Shoemaker type; that his shift, as operator, is from 3:30 P. M. until midnight, and that on or about the first day of May, 1911, while tuning for signals between 10 and 11 o'clock, he picked up a wireless telephone message from William Dubilier's telephone station located at Seattle, Wash., and was able to hear the voice clearly and could catch the words distinctly. 'Hello, hello, hello', then nearby telegraph stations interfered, so that the signals became intermittent, but at the end he again heard the voice distinctly, 'Good night'. Affiant further states that on other occasions, while on duty at such station, he picked up portions of musical selections and conversations, all of which could be distinctly heard." The date of the affidavit is July 20, 1911.

Faded newspaper clippings that crumbled at the touch, also found in the old filing case, revealed the public skepticism of the whole affair. However, excited reports about the "wireless telephone music", issue by amateur and commercial operators, aroused the interest of the Seattle newspapers, and Dubilier had to stage a sharply-scrutinized demonstration to prove his telephone really was "wireless". In the spring of 1911 he loaded a receiving set into a large open touring car—one of those early contraptions without windshield or top—drove it about half a mile from the transmitting station, and passed the earphones around to skeptics who were prepared to denounce but who remained to marvel. This incident also marked one of the very earliest uses of radio in an automobile, even though it was necessary to stop the car and string an antenna wire to a long pole, carried for the purpose.

Overnight, Dubilier became a sensation, the local "boy hero". One newspaper writer of the period, who probably did not realize how accurate his prediction would be, wrote in a Seattle

A clipping from a Seattle, Washington, Newspaper, dated Oct. 30, 1910.

HERE IT IS!

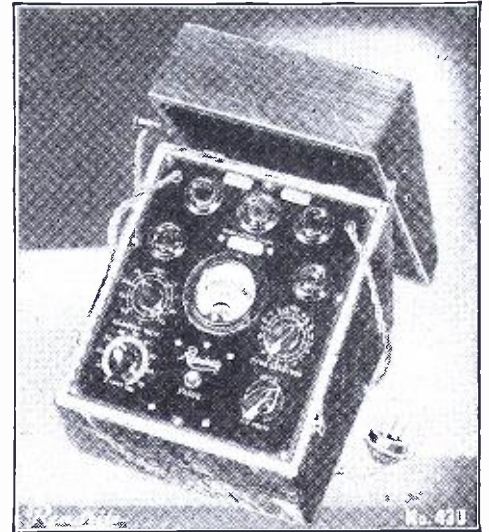

No 430 Tests Metal Tubes!

THE Model No. 430 has five sockets that are flush with the sloping panel. One socket is equipped to test the new 8-prong metal Octal tubes. Another feature of this new tester is the shadow-type line voltage meter . . . located directly above the moving-coil type instrument . . . which tests Good and Bad tube values. Direct reading. Controls are simple and positive in action. This new all-type tube tester makes every inter-element short and leakage test, in a manner instantly convincing to the customer. Removable cover for either portable or counter use.

At Your Jobber's

. . . Previous Readrite models can be adapted for testing the new Octal tubes.

Write today for full information about the No. 430 Tester

READRITE METER WORKS
167 College Ave., Bluffton, Ohio



Bargain Bulletin

NEW ISSUE JUST OUT

SEND FOR THIS

FREE CATALOG

Check full of BARGAINS in RADIO SETS, Long and Short Wave Apparatus, Servicemen's Repair and Replacement Parts, Electrical Appliances and hundreds of miscellaneous specials at TREMENDOUS SAVINGS.

Get this big new Bargain Book. It's absolutely FREE without obligation—just send us your Name and Address on a post card

WRITE FOR YOUR COPY NOW.

JUST OFF THE PRESS

RADIO CIRCULAR CO., INC.
225 RC VARICK ST., NEW YORK

OSCILLOGRAPH!

Here at last is a publication consisting of 4 complete, easily understood, illustrated lessons telling you ALL about the CATHODE RAY TUBE OSCILLOGRAPH—Where it can be used—exactly HOW to use it in EVERY radio service application. Hundreds already sold to servicemen who recognize the tremendous importance of the oscillograph! Get yours today.

ONLY \$2

Send check or money order or write for FREE details. Address: F. L. Sprayberry, 2548 University Place, N. W., Washington, D. C.

While the Edition Lasts

"TESTING RECEIVERS"

SPRAYBERRY

WITH THE OSCILLOGRAPH"

ALL THE NEWS THAT'S FIT TO PRINT | First Edition

SEATTLE BOY TAKES WORLD RECORD

Invents Wireless Telephone That Reaches Tacoma

HEARTY PIRATES' CHICAGO PLUNGE PROVES UNDOING

HE STILL LIVES HERE, BUT ASKS FOR 'PLUNGE'

The Seattle Sunday Times

SEVENTY FOUR PAGES SEATTLE, WASHINGTON, OCT. 30, 1910. FIVE CENTS

Young Inventor and Perfected Wireless Phone

WIZARD YOUTH PLUCKS VOICES FROM THIN AIR

Seattle Man So Made Famous by Astounding Success of Young Wireless Telephone with Wireless Telephone

BIG FACTORY TO MAKE INSTRUMENTS PLANNED

Large Planting Plans At West as Romantic and the most as that of the first factory of Wireless Phone



JAPAN FORCED TO EXTEND LIGHT ON

SCIENCE EXPERTS ANALYZING PROBE

ON BED IN COURT RECALCITRANT DEATH

LOEB CONTINUES DEFENSE REFORMS

ASTOUNDING PACT ENDS VOTE BUYING

Please Say That You Saw It in RADIO-CRAFT

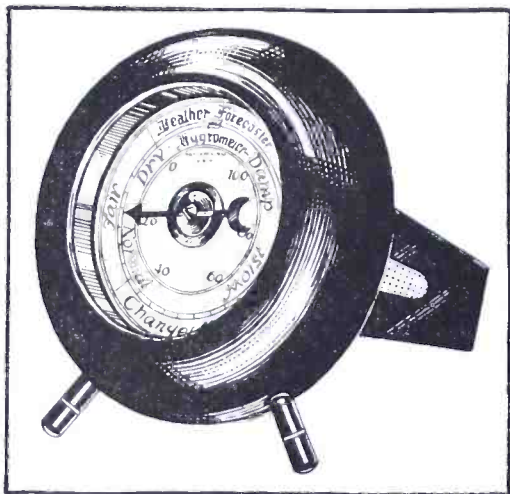

Something **NEW!**

**Weather Forecaster
and Humidity Tester
"HYGROSCOPE"**

The Ace of Weather Forecasters

When placed in a well-ventilated room or in the fresh air, the HYGROSCOPE foretells coming weather conditions from eight to twenty-four hours in advance. It also accurately records outdoor humidity, and when placed inside it gives the humidity within the house or room.

The HYGROSCOPE is automatic, self-adjustable, simple American-precision made. It cannot get out of order at any time. The dial measures 2 3/4" is enclosed in a 6" round hardwood case, with either walnut or mahogany finish. It is attractive for desk or living room.

**OUTSIDE DIAL
FORECASTS WEATHER**

Fair—rain—or changeable is indicated on the outer dial when the HYGROSCOPE is placed in a well ventilated room or out-of-doors. If indoors, place the instrument near an open window.

**INNER DIAL SHOWS THE
HUMIDITY CONTENT**

The HYGROSCOPE also acts as a hygrometer. Numbers on the inner dial indicate the degree of humidity present in the air and in artificially heated rooms.

SEND YOUR ORDER NOW! Get your HYGROSCOPE today. Your remittance in form of check or money order accepted. If you send cash or unused U.S. Postage Stamps, be sure to register your letter. Also specify if you prefer the HYGROSCOPE in Walnut or Mahogany. All orders are shipped immediately.

\$2.00
POSTPAID

MAIL THE COUPON BELOW!

GRENPARK COMPANY
99 Hudson St. New York, N. Y.

GRENPARK COMPANY, RC-835
99 Hudson Street, New York, N. Y.

Enclosed you will find my remittance of \$..... for which send me at once, POSTAGE PREPAID, HYGROSCOPES at Two Dollars each.

Walnut Model Mahogany Model

Name

Address

City State.....

(Send your remittance in check or money order. If your letter contains cash or unused U. S. Postage Stamps, be sure you register it.)

paper as follows:

"Eventually it (i.e., the wireless telephone) will be used on land and sea and should become the greatest commercial enterprise in the world. Connecting every town and hamlet, installed on ocean going and coastwise ships, it will in time penetrate every section."

More to save his tired throat than to provide planned entertainment, Mr. Dubilier relates, he put the horn of a phonograph in front of the microphone and played and replayed whatever records he could find. There were a few pioneer amateur wireless enthusiasts in Seattle at the time, and their number increased as news of the magic wireless music flashed around and schoolboys discovered they could make receiving sets out of rolling pins and bits of galena.

In the summer of 1912 one enterprising youth installed a home-made receiver in a booth at a Seattle amusement park and erected a sign reading "Music, Both Vocal and Instrumental, Vaudeville and Jokes by Wireless Telephone." He charged visitors ten cents for the privilege of listening to Dubilier's squeaky talking machine and he did a land-office business whenever the station was on the air.

With a power of 2 kw., Dubilier's voice and music reached Tacoma, 30 miles away, a feat heralded by the Seattle press with "scare heads" reading "Seattle Boy Takes World Record—Invents Wireless Telephone that Reaches Tacoma." Dubilier was no Seattle boy, but a native of New York, but that wasn't important. Tatoosh, Wash., a distance of 128 miles, was another accomplishment for the arc transmitter, and ship operators 75 miles off shore tuned in the signals when conditions were good.

Oddly enough, in spite of the local furor, this early station did not seem to make much of an impression on the country at large; in fact there is little if any reference to it in historical works. Dubilier, who is now vice-president in charge of research of the Cornell-Dubilier Corporation, of New York, went to Russia in 1912 to install a chain of stations there, was entertained by the Czar, and achieved wealth and international recognition as the inventor of the mica-dielectric fixed condenser, a submarine detecting device and numerous other electrical instruments.

The Seattle transmitter was forgotten and Dubilier himself doesn't know what happened to it. Not until ten years after his sensational visit to that Pacific port did the American public wake up to the possibilities of radio broadcasting; that was in 1920, when KDKA, the Westinghouse station in Pittsburgh, broadcast the Harding election returns.

Dubilier's 1910 "broadcasting" was by no means the first. Other experimenters had preceded him and obtained more recognition, but at least his name can now be added to the list of men who contributed to the art.

**A BEGINNER'S
"2-in-1" A.F. Amplifier**

(Continued on page 108)

The illustration below shows the back of the amplifier with all parts in place and the wires connecting to the detector and the batteries. The positions of the transformers, tube, binding posts, condenser and resistor are readily seen. The wiring is shown on page 83.

The rear of the amplifier showing parts.

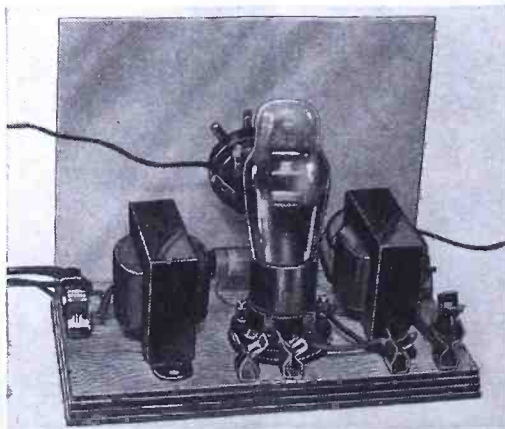

**12 BOOKS TO HELP
YOU LEARN MORE
ABOUT RADIO**



Illustrated at the right and left are two books in the Radio-Craft Library Series.

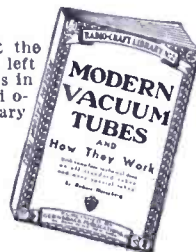

THE RADIO-CRAFT LIBRARY SERIES—a most complete and authentic set of volumes—treats individually, important divisions of radio. Each book has been designed to give you the opportunity to learn one or more branches of radio. The authors of the books are well-known to everyone. Each is an expert radio man; an authority on the subject—each is thoroughly familiar with the field which he represents.

All Books Uniform

The volumes in the RADIO-CRAFT LIBRARY SERIES are all uniform, 6 x 9 inches. Each book contains on an average of 50 to 120 illustrations. The books are printed on an excellent grade of paper which makes the type easy reading.

Here Are the Series:

- Book No. 1
RADIO SET ANALYZERS
And How to Use Them By L. VAN DER MEL
- Book No. 2
MODERN VACUUM TUBES
And How They Work By ROBERT HERTZBERG
- Book No. 3
THE SUPERHETERODYNE BOOK
All About Superheterodynes By CLYDE FITCH
- Book No. 4
MODERN RADIO HOOK-UPS
The Best Radio Circuits By R. D. WASHBURNE
- Book No. 5
HOW TO BECOME A RADIO SERVICE MAN
By LOUIS MARTIN
- Book No. 6
BRINGING ELECTRIC SETS UP TO DATE
By CLIFFORD E. DENTON
- Book No. 7
RADIO KINKS AND WRINKLES
For Service Men and Experimenters By C. W. PALMER
- Book No. 8
RADIO QUESTIONS AND ANSWERS
By R. D. WASHBURNE
- Book No. 9
AUTOMOBILE RADIO AND SERVICING
By LOUIS MARTIN
- Book No. 10
HOME RECORDING AND ALL ABOUT IT
By GEORGE J. SALIBA
- Book No. 11
POINT-TO-POINT RESISTANCE MEASUREMENTS
By CLIFFORD E. DENTON
- Book No. 12
PUBLIC ADDRESS INSTALLATION AND SERVICE
By J. T. BERNSELY

BIG DISCOUNT OFFERED

**When Five (5) Books or More
Are Ordered, Deduct 20% from
Your Remittance**

GERNSBACK PUBLICATIONS, INC.
99 Hudson Street, New York, N. Y.

MAIL THIS COUPON TODAY!

GERNSBACK PUBLICATIONS, INC.
99 Hudson Street, New York, N. Y.

I have circled below the numbers of books in the RADIO-CRAFT LIBRARY SERIES which you are to send me, and have deducted 20% for ordering five (5) books or more. I have included my remittance in full, at the price of 50c each, when less than five books are ordered.

The amount of my remittance is..... (stamps, checks or money orders accepted). Circle numbers wanted:

1 2 3 4 5 6 7 8 9 10 11 12

Name

Address

City State.....

All books are sent postage prepaid

RC-835

Please Say That You Saw It in RADIO-CRAFT

WORLD-WIDE TELEVISION

(Continued from page 80)

In this connection it is interesting to note that here in America the gap between the almost feverish activity of a few years ago, and the present, more healthy interest in the subject, is not at first noticeable. Refer now to the listing, "Television Stations in the United States." Not even this latest, most accurate listing in existence, tells the whole story. (At this writing there is only one application for a television permit now pending before the Federal Communications Commission, as indicated in the listing.) A survey by *Radio-Craft* has brought forth the following interesting information.

Columbia Broadcasting System, Inc., has temporarily discontinued operation of experimental television station W2XAB; it cannot be definitely stated at this time just when activities will be resumed.

Philo Radio & Telev. Corp. attributes the greatly increased interest in television, to the announcements of experimental field tests, but has no material to offer for publication.

The work of The Milwaukee Journal station, WTMJ, is purely of an experimental nature, primarily aimed at determining the transmission characteristics of the ultra-high frequencies as they relate to television, no thought having been given to the possibility of regular television programs (on the grounds that this is a matter for the larger laboratories to delve into).

Eastman Kodak Co., reported to be doing work on film for use in the intermediate-film system of television, prefers to say that they have nothing in that line. (This seemingly leaves Germany and England as leaders in this branch of the camera art, as described elsewhere in this article.—*Editor.*)

National Television Corp. (New York) is reported to be working up a receiving unit based on its own system of transmissions, a modification of the Nipkow disc.

All television work in the East by Pioneer Mercantile Co. is temporarily suspended, only the Bakersfield, Calif., labs. continuing in operation, over station W6XAH. (See, "A Modern Picture of Television," in the April and May, 1935 issues of *Radio-Craft*.)

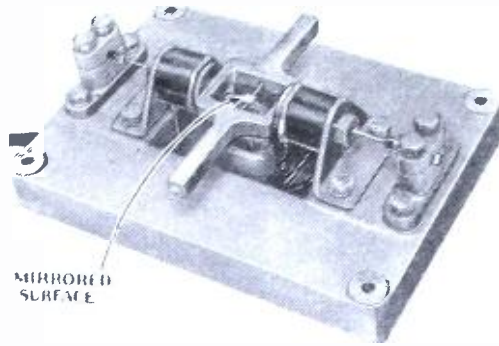
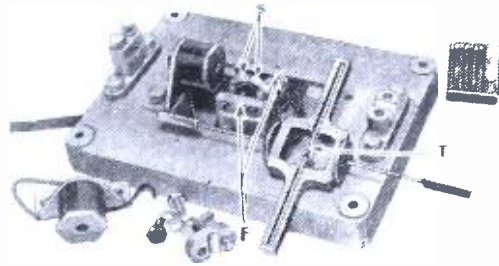

Fig. 39, above. The Preiss scanner. This component is used for transmitting and receiving.

Fig. 40, below. The scanner disassembled. The mirrored magnetic vane is tuned to scanning frequency (5,000 cycles—200 images—per second) by filing tab T; it is oscillated against torsion by scanning magnets S. The entire mounting which resonates at 24 cycles, is oscillated by framing-frequency magnets F.



The Sparks-Withington Co. (Michigan) does not have anything to release on television at this time, and does not expect to have anything this summer.

John V. L. Hogan (Radio Pictures, Inc., New York) is regularly broadcasting on 2,000-2,100 kc., over station W2XDR—60-line image, 20 images per second—on Tuesdays and Thursdays, between 11:30 A.M. and 12:30 P.M. (1 hour).

International Television Radio Corp. (William H. Priess). This organization has developed an inexpensive, compact and efficient scanning unit that utilizes a high-intensity, concentrated-spot arc light and a vibrating mirror.

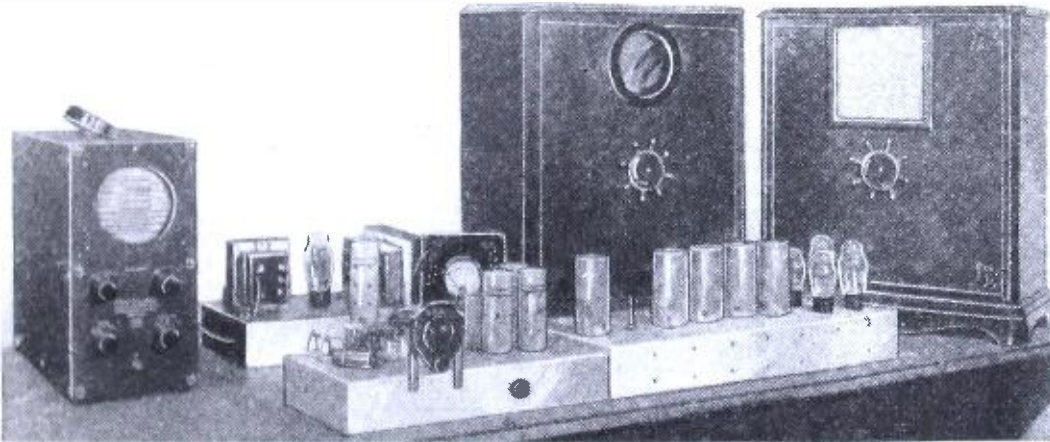
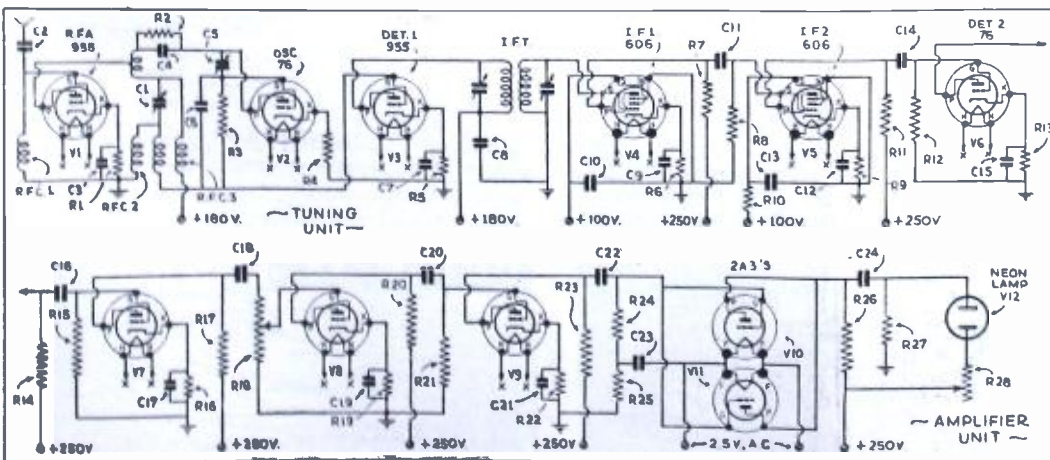

Fig. 37, above. The television receivers used at station W9XAT, Minneapolis.

Fig. 38, below. Schematic of the Northwestern television tuner and amplifier units.



Please Say That You Saw It in RADIO-CRAFT

WRIGHT-DECOSTER Multi-Test Speaker

For the Sound Engineer and Service Men

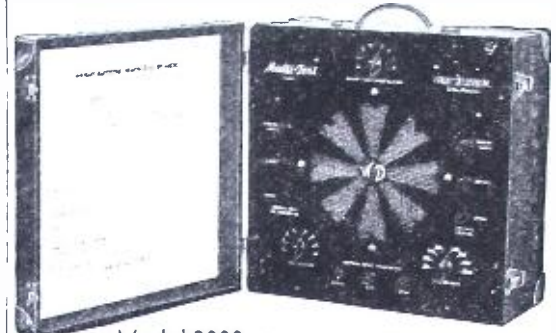

Model 3000
List Price \$30.00

Matches all tubes and all output transformers.
Matches all set field combinations.

Get One for \$7.50

Upon deposit of \$15.00 with your wholesaler, he will ship you a Wright-DeCoster Multi-Test Speaker. He will accept 75 Wright-DeCoster coupons (packed with all Wright-DeCoster Products) as a merchandise credit of \$7.50 against your \$15.00 deposit, thus making this Multi-Test Speaker cost you only \$7.50.

This Wright-DeCoster Multi-Test 8" Speaker is really indispensable to the wide awake service man. It enables him to check the speaker in any set in a very few minutes. Furthermore, it enables him in many cases to demonstrate to his customer how much better the set will sound with a new Wright-DeCoster Speaker.

Write for complete catalog, dealer's discount and name of nearest Wright-DeCoster distributor, who will cooperate with you in every way possible.

WRIGHT-DECOSTER, Inc.
2251 University Ave. St. Paul, Minn.
Export Dept.:—M. Simons & Son Co.
Cable Address: SIMONTRICE, New York.



MAKE YOUR OWN RECORDS From Radio or Voice

New Professional Record

CUTTING DEVICE which cuts with highest precision. Any metallic or non-metallic disc material. Can be mounted on any existing turntable with a minimum of driving power required. Positive feed away or toward the axis. Ideal, inexpensive recording device for the amateur or professional.

Complete, ready to attach to radio or amplifier, \$31.50. This is the greatest value ever offered on a direct recording device. (Patent Applied For).

For further details write

SOUND APPARATUS COMPANY
Manufacturers of Disc Recording Apparatus
150 West 46th St. New York, N. Y.

Ken-Rad Radio Tubes

DEPENDABLE LONG LIFE

Ken-Rad Radio Tubes are made to give clear, dependable reception. They satisfy customers and build good will for dealers. Write for full information.

THE KEN-RAD CORP., Inc., Owensboro, Ky.
Division of The Ken-Rad Tube and Lamp Corp.
Also Mfrs. of Ken-Rad Incandescent Electric Lamps

SPECIAL— This Month Only for ORSMA MEMBERS

THE OFFICIAL RADIO SERVICE MEN'S ASSOCIATION has arranged to supply a number of "Service Men's essentials" for its members and associate members only.

These essentials are priced at cost, plus a small additional fee which is the only source of income that the Association has. No one obtains any profit or benefit, except the Association itself. Whatever profit accrues, is reinvested for the furtherance and enlargement of the Association.

By using the letterheads, billheads, etc., you present the business-like appearance to your customers. In addition, the Association has made arrangements with most of the prominent manufacturers to allow special discounts to members, providing ORSMA letterheads are used when ordering.



ORSMA LETTERHEADS

These letterheads, shown above, are furnished with your name, address and telephone number, printed on excellent paper. They are sold in lots of 100 or multiples thereof, with a distinct saving for single orders of 1,000 or more. **Per 100, 60c; per 1000, \$3.00.**

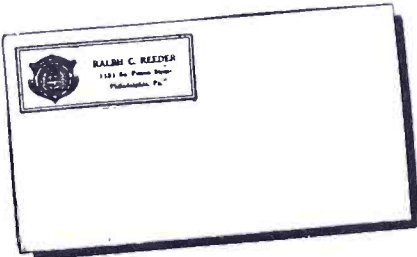

ORSMA ENVELOPES

These are furnished to match the letterheads, printed with your name and address and seal of the Association. They go hand in hand with the letterheads and are usually ordered in the same quantity. **Per 100, 60c; per 1000, \$3.00.**

Write for complete details about membership in the OFFICIAL RADIO SERVICE MEN'S ASSOCIATION. State whether you prefer Full Membership or Associate Membership.

OFFICIAL RADIO SERVICE MEN'S ASSOCIATION
99 Hudson Street, New York, N. Y.

Please send me the following RADIO SERVICE MEN'S ESSENTIALS which I have selected from this advertisement. My remittance for \$..... is enclosed. Send remittance in form of check or money order. Register letter if it contains cash, currency or unused U. S. Postage Stamps.

Name ORSMA No.

Address City and State

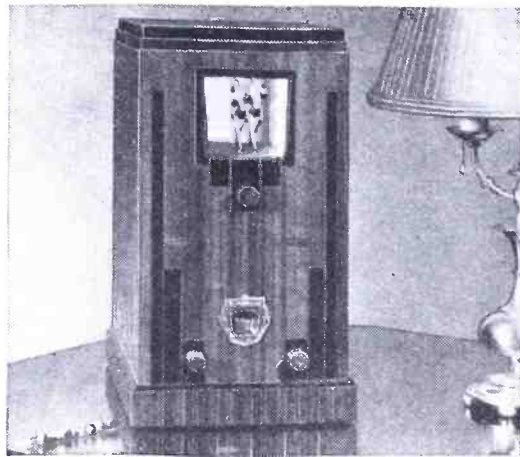

Fig. 41. 243 towns near Iowa City can use this type of television and sound receiver.

The magnet system vibrates the mirror in one plane at 5,000 cycles per second for 200-line scanning; a second magnet system vibrates the mirror in the second plane for picture framing at 24 pictures per minute. High electrical and mechanical efficiency are obtained by making the moving rod and rod-mounting resonate at the operating frequencies used in scanning and framing, respectively. Excellent illumination even in frame sizes up to 2 and 3 feet is obtained by using a very powerful light source, the beam of which is focused on the mirror and reflected in the usual manner employed by mirror scanners. Factory production methods will reduce the manufacturing cost of the complete scanner, illustrated in Figs. 39 and 40, to a very low figure—about \$4, it is estimated.

"LINES" VS. "LINES-PER-INCH"

Many students of television have misinterpreted the word "lines," in defining image definition, having confused it with the "lines-per-inch" expression used in the printing trade to designate the "screen" required for reproduction of certain illustrations. This confusion probably would not have arisen, had the designation not been contracted from the original—"lines-per-image."

From this explanation it will be seen that the number of lines, then, is a function of the size of the image area as a whole, rather than of any particular, marked-off area (for instance, a 1-in. area) within that boundary. (See Fig. 43).

By reference to Fig. 32 it will be noted that, regardless of the size of the image area, there are substantially only 80 (for example) lines, total, over the entire surface of the image or picture area. Thus, we have a choice of getting close to a small image having, let us say, 80 lines, or of getting further away from the image and then enlarging the image until the fidelity of reproduction equals that of the smaller image—the image will not then appear more "clear" to us, because there has been no change in the number of lines per image area (this figure is entirely dependent upon the design of the scanning mechanism—if a disc is used, the total number of holes in the spiral determines the number of lines-per-image; if a cathode-ray tube, the adjustment of the sweep-circuit oscillator), but a greater number of people can now view the screen. (The light in-

Fig. 42. Experimental set-up by von Ardenne; television reception in Germany.



Please Say That You Saw It in RADIO-CRAFT



There's plenty of SERVICING MATERIAL in the 1934 Manual!

Radio Service Men and others engaged in various branches of radio know the importance of the GERNSBACK Manuals, and how much they depend on them for reliable information. Whether for public address work, receiver diagrams or tube information, the material needed is certain to be found in one of the volumes of the OFFICIAL RADIO SERVICE MANUAL.

Contents of the 1934 Manual in Brief

Diagrams and service notes, more complete than ever before in any manual. Voltage readings for practically all sets, as an aid in checking tubes and wiring. All values of I.F. transformers used in superheterodynes, with the manufacturers' own suggestions as to correct balancing. A complete compilation of radio tube data, covering both old and new types. A complete list of American broadcast stations with their frequencies in kilocycles; extremely useful in calibrating test oscillators and receivers. Free question and answer service. No theory; only service information in quickly accessible form. A handy, easily-consulted master index making it easy to find almost anything pertaining to service problems. Instantly. This index includes all the diagrams published in all the previous GERNSBACK manuals, as well as the 1934 diagrams. A big convenience and time saver.

400 PAGES

Over 2,000 ILLUSTRATIONS
9x12 Inches

Flexible Looseleaf Leatherette Cover

Send remittance of \$3.50 by check, money order or unused U. S. Postage Stamps. Register letter if it contains cash or stamps. **MANUAL SENT POSTAGE PREPAID.**

GERNSBACK PUBLICATIONS, Inc.
99R Hudson Street, New York, N. Y.

- - a new magazine
for short-wave fans!

SHORT WAVE LISTENER

4,600 Short Wave stations listed



THE finest magazine of its kind ever published—totally different in get-up and contents from any other. Contains the largest listing of short wave stations in the world, up-to-the-minute, including "Police," "Television" and short-wave stations, as well as a special list of the star short-wave stations with their frequencies and call letters. Also contains photos and descriptions of short-wave broadcasting stations in various parts of the world with photos of short wave studio artists

25c
THE COPY

—How to locate "weak" distance stations, and other hints for the "short-wave listener"—Question and Answer Department for the "listener"—Silver Cup Trophy for best photo of readers' listening "Posts," etc.

ON ALL NEWSSTANDS **SHORT WAVE LISTENER**
99 Hudson St. New York, N. Y.

BUILD IT YOURSELF

You can build this Trailer with ordinary tools easily from our step-by-step constructional sheets and large sized blueprints. Finest designed Trailer in existence, sleeps 4. Toilet, Shower, Electric Light, etc. Save 75% of the cost by building it yourself. Send 25c for plans sheet, illustrations and details.
THE PLAN SHOP, 910 Palmolive Bldg., Chicago, Ill.

tensity is less on a large screen, for a given scanner light-output, than it is on a small screen, tending to fade to a large extent if a weak light-source is used and the image projected to a very large screen—because the reduction in light intensity is in proportion to the square of the distance from the light source; another factor in reducing the light-intensity of the image is the proportion of image light to incident (room) light on the screen.)

This ability of the eye to define the image is affected by the low intensities of illumination (except, if you will, the strong light secured by some "projection" systems, as for instance the intermediate-film process whereby a weak light affects a photographic film which, a minute or so later, is used to modulate the intense light of an electric arc), and by the intermittent character of the light which we ordinarily must employ in television.

Low intensity of illumination reduces the ability to distinguish details because the iris of the eye expands in poor light to allow a maximum of illumination to enter the eye—light rays from a given point passing through different parts of the optic lens do not all focus together (thus, points now very close together become indistinguishable).

Intermittent light and low illumination intensity result in poor focusing power.

With this explanation the relation between picture "definition" (the amount of detail that can be discerned in the image—eyebrows, eyelashes, wrinkles, nose, etc., on a face, for example), lines-per-image, and lines-per-inch, and the size and distance of the screen may now be visualized by reference to Fig. 33.

LATEST ADVANCES IN TELEVISION TECHNIQUE

This article would not be complete without reference to some of the outstanding improvements that have been made in the art, during the last few years.

Not the least of these was of course the Zworykin "Iconoscope" which permitted cathode-ray technique to be adapted to the transmitter or picture pick-up equipment. A later development in this field of electronics is the Farnsworth "Image Dissector." Scanning is accomplished by electronic emission from the pick-up plate onto which the transmitting image is projected.

Due to the extreme sensitiveness of the photoelectric material used on this plate the number of electrons coming from each single elementary area of the image is too small to supply a current capable of being directly amplified in a

tube amplifier which, even if designed to have very low noise level, is not suitable for amplification of weak currents.

The difficulty is overcome by the use of an "electronic multiplier," placed immediately next to the "anode-plate," which utilizes the secondary emission for the purpose of increasing the current of electrons, and operates as a kind of preamplifier. It is free from distortion; and since it permits an amplification 1,000 times that of the original electronic impulse it is possible to transmit with it images out in the open, even in conditions of only moderate illumination.

A second development of vast importance is the "coaxial conductor" transmission line (a conducting wire within a conducting tube), first described in the April, 1935 issue of *Radio-Craft*, page 583, and again in this issue. This cable makes long-distance wired television practicable. The high cost of the cable however probably will limit its use except for tie-in between network stations, the picture programs of national interest being received via ultra-short-waves over local stations having a service area of about 25 to 50 miles radius.

A third development on which considerable progress has been made is "color television." As Allen B. Dumont states in this issue, color television is readily attainable in the laboratory. Just when it will be commercially available is another question; the apathy with which the public has accepted color "movies" would seem to indicate that announcement of color television will not arouse interest nearly in proportion to the financial outlay that such a development would entail.

Means for accomplishing television modulation within the narrow limits of 10 (or, for high-fidelity-allotted bands, 20 kc.) have been experimented with. Much progress has been made in this direction by W6XAH at Bakersfield, Cal., utilizing the single-side-band system. There has been some talk to the effect that the Armstrong "frequency-modulation" system, especially intended for use on ultra-short-waves (5 meters, and less), on a given radio-frequency band will permit a much wider range of audio-frequency modulation than will our present, "amplitude-modulation" system. It is rumored that one well-known engineer, famous for his inventions in television, concedes that a system can be developed which will permit better than 100 kc. modulation on a single 10 kc. band anywhere in the frequency spectrum.

Speculation concerning such eventualities is of interest because it immediately opens the gates to the possibility of INTERNATIONAL TELEVISION. Just as an example, let us imagine that the television equipment illustrated

Fig. 43.

Comparison of 60 line (A) 120 line (C) 180 line (B) and 240 line (D) scanning.

Courtesy RCA.

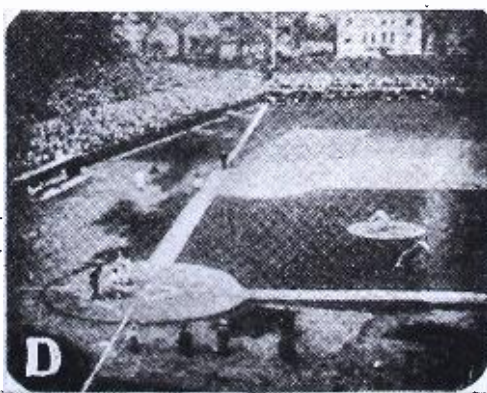
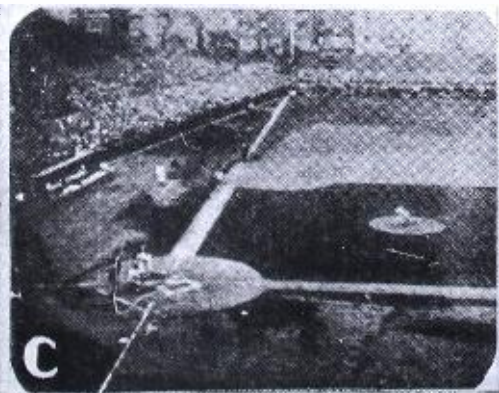
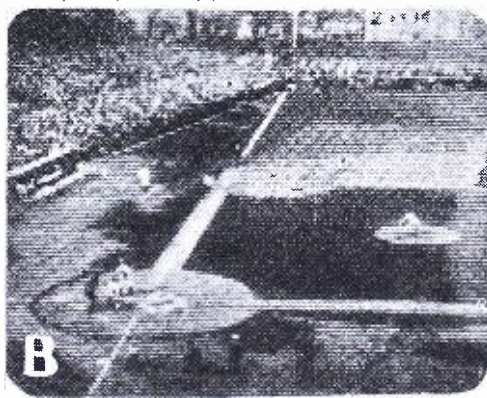
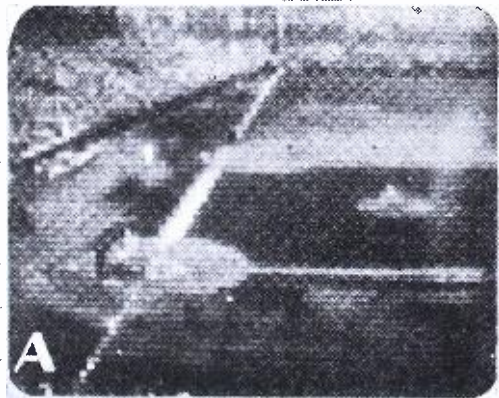

Please Say That You Saw It in RADIO-CRAFT

Train Now for New RADIO Opportunities



Get Into a Line Where There's Action—Every Day—And a Payday Every Week—You Be the Boss!

Analyzer & Resistance Tester—Latest Design—YOURS Without Extra Cost

Right now while hundreds are looking for work where there isn't any, the radio service field can use trained men. With the proper training and the necessary equipment, you can enter this field and make a comfortable living.

We include with our course this modern set analyzer and trouble shooter without any extra charge. This piece of equipment has proved to be a valuable help to our members. After a brief period of training, you can take the set analyzer out on service calls and really compete with "old timers." We show you how to wire short-wave receivers—analyze and repair all types of radio sets—and many other profitable jobs can be yours. Teaching you this interesting work is our business and we have provided ourselves with every facility to help you learn quickly yet thoroughly. If you possess average intelligence and the desire to make real progress on your own merits, you will be interested.

ACT NOW—MAIL COUPON

Start this very minute! Send for full details of our plan and free booklet that explains how easily you can now cash in on radio quickly. Don't put it off! Write today. **SEND NOW!**

RADIO TRAINING ASSN. of AMERICA
Dept. RC-58, 4513 Ravenswood Ave., Chicago, Ill.

Gentlemen: Send me details of your Enrollment Plan and information on how to learn to make real money in radio quick.

Name.....

Address.....

City.....State.....

YOURS for the Asking

(1)—FREE NEW CATALOG of Condensers, Transformers, Chokes, Sockets and general equipment for receiving and transmitting.

(2)—SEND 10c for New 32-page Manual of most popular Short-Wave Receivers, with illustrations, diagrams and parts lists.

Address Dept. RC-8

HAMMARLUND MANUFACTURING CO.,
424-438 W. 33rd St., New York.

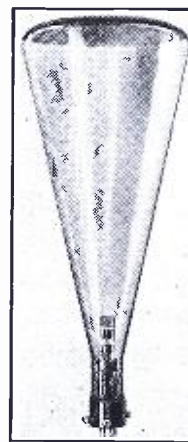

THE PIONEER MANUFACTURER

of
Cathode Ray Tubes
and
Oscillographs

FOR ALL PURPOSES

Allen B. Du Mont Labs.
Upper Montclair, N. J.

NEW METAL TUBE SOCKETS

ADAPTERS, CAP CLIPS, ETC., NOW READY. Set and instrument manufacturers, experimenters, service men and short wave fans, send for literature showing new metal tube accessories.

ALDEN PRODUCTS CO.
Dept. RC-8 715 Centre St.
BROCKTON, MASS.

Many Auto-Radios Installed Last Summer Now Need Servicing

Auto-radios installed during the past six months usually need some minor adjustment—new tubes, new suppressors or other parts. Perhaps the job will even be more difficult than you'll find how needy the Auto-Radio Service Manual is to repair the job quickly.

Volume I

\$2.50
LIST



To everyone who now purchases the OFFICIAL AUTO-RADIO SERVICE MANUAL this big 48-page Supplement is issued FREE. Practically all of the latest sets, together with servicing information will be found in these new pages. The new Supplement does not increase the cost of the book to you, but gives you an Auto-Radio Service Manual that is right up-to-the-minute with service notes.

Good Money in Servicing Auto-Radios

If you are overlooking servicing auto radios, you're missing a great deal of business. The auto-radio business had its greatest boom last summer when thousands of sets were sold. By now many of these same sets require servicing and with hundreds of them right in your own community, you can build up a good auto-radio servicing business. In a short time you can easily add 25% profit or more to your regular servicing business.

List of sets covered in the Manual

- | | |
|-------------------------------|---------------------------------|
| Acme Radio Mfg. Co. | P. B. Mallory & Co. |
| Allied Radio Corp. | Melborn Radio Mfg. Co. |
| Atwater Kent Mfg. Co. | Montgomery Ward & Co. |
| Audlola Radio Co. | National Co., Inc. |
| Autocrat Radio Company | Noblitt-Sparks Ind., Inc. |
| Automatic Radio Mfg. Co. | Phileo Radio & Tel. Corp. |
| Carter Genemotor Corp. | Pierce-Airo, Inc. |
| Century Radio Prods. Co. | Premier Electric Co. |
| Chevrolet Motor Company | Radio Chassis, Inc. |
| Consolidated Industries, Ltd. | RCA-Victor Co., Inc. |
| Crosley Radio Corp. | Sentinel Radio Corp. |
| Delco Appliance Corp. | Sparks-Withington Corp. |
| Detrola Radio Corp. | Stewart Radio & Tel. Corp. |
| Emerson Electric Mfg. Co. | Stewart-Warner Corp. |
| Fada Radio & Elec. Corp. | Stromberg-Carlson Tel. Mfg. Co. |
| Federated Purchaser, Inc. | Transformer Corp. of Am. |
| Ford-Majestic | United Amer. Bosch Corp. |
| Franklin Radio Corp. | United Motors Service |
| Galvin Mfg. Corp. | U. S. Radio & Tel. Corp. |
| General Electric Co. | Utah Radio Prods. Co. |
| General Motors Corp. | Wells-Gardner Company |
| A. H. Grebe & Co. | Wholesale Radio Serv. Co. |
| Grisby-Grunow Co. | Rudolph Wuriltzer Mfg. Co. |
| Chas. Hoodwin Company | Zenith Radio Corp. |
| International Radio Corp. | |

Over 200 Pages
Over 500 Illustrations
9 x 12 Inches
Flexible, Loose-Leaf Cover

MAIL THIS COUPON TODAY!

GERNSBACK PUBLICATIONS, INC. RC-8-35
99 Hudson Street, New York, N. Y.

Enclosed you will find my remittance of \$2.50 for which please send me One Copy of the OFFICIAL AUTO-RADIO SERVICE MANUAL with FREE 48-page Supplement. Send remittance in check or money order. Register letter if it contains cash or currency. WE PAY POSTAGE.

Name
Address
City State.....

on page 78 of this issue, is used to modulate the output of some one of the high-power, short-wave stations located in Japan which are now received in the United States (even on the Eastern seaboard). Such television programs while of an experimental, and even "fad" nature, will have a very important psychological effect toward arousing interest in the subject generally; the feat would parallel in the television field, the epoch-making trans-oceanic flight of Lindbergh.

Before closing this article mention should be made of the national television plans for Germany mentioned in the May 24th, last, issue of *Wireless World* (London).

According to this report, Germany not only has in operation the Berlin television station mentioned in the preceding part of this article, but also plans to put into operation a service of 21 television stations, the combined coverage of which will extend over practically all of Germany.

The high quality that is now a regular feature of the Berlin transmissions is evident by reference to Fig. 42, which illustrates an image received last May by Manfred von Ardenne on the latest type of cathode-ray equipment so far developed by him. (The illustration has been retouched only sufficiently to maintain the excellent half-tone characteristics exhibited by the original glossy photograph, after the 100-screen "printing screen" was used for purposes of publication.)

(Appreciation is extended not only to the companies and individuals previously mentioned in this article, for their cooperation in furnishing illustration and technical data, but also to the following: Cosmo Press, Dr. Otto Steinitz, Eckert Klein, J. Lawrence Cassell, Hans F. Kutschbach, E. B. Kurtz, L. C. Paslay, J. Francis Dusek, E. J. Coxey, S. Q. Noel, Herbert Rosen, J. Varley Roberts, Rudolf C. Hergenrother, Anning S. Prall, A. L. Gulliland, Howard J. Perry, and Kurt Lang.—The authors)

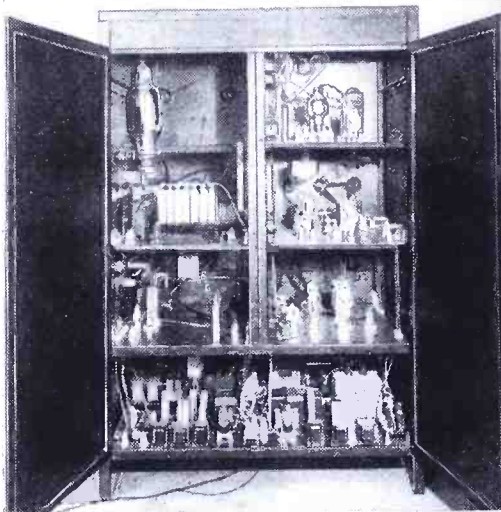

Fig. 34
Interior of the transmitter—W9XAT.

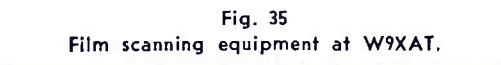
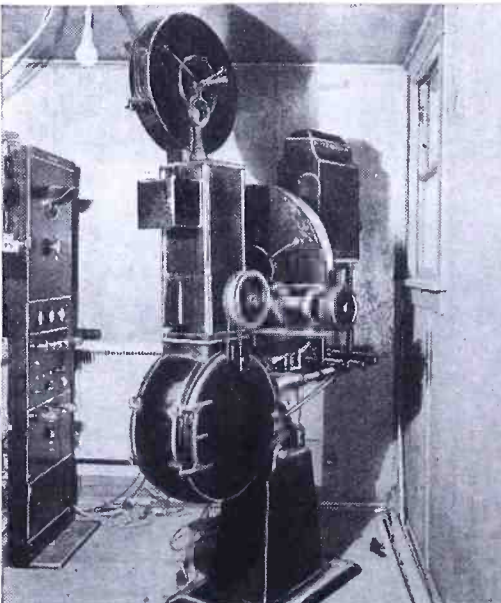

Fig. 35
Film scanning equipment at W9XAT.



A MAGAZINE WHICH NEEDS
NO INTRODUCTION
TO SHORT-WAVE FANS

SHORT WAVE CRAFT

This popular monthly magazine, *SHORT WAVE CRAFT*, contains everything you want to know about Short Waves.

The wonders of world-wide short-wave reception are clearly described and illustrated. Latest practical information for radio fans, experimenters and "hams" will be found. Tells you how to build short-wave receivers and transmitters; construct sets of one and two tubes or as many as seven, eight or more. Tells best foreign stations to log and when to tune them—includes newest and best circuits of the time. *SHORT WAVE CRAFT* is edited by Hugo Gernsback.

NEW FEATURE RECENTLY ADDED—To the short wave fan who has logged and obtained verification of the largest number of short-wave stations from all over the world during one month, will be awarded a magnificent 24" silver trophy.

Special This Month Only!

For the month of July only, we offer readers of this magazine the opportunity to read radio's greatest short-wave magazine at a special saving. The regular subscription price is \$2.50 per year. You can now get *SHORT WAVE CRAFT* for the next

**8 MONTHS
FOR \$1.00**

4-Color Cover
Over 200 illustrations
9x12 inches in size

25c The Copy
ON ALL
NEWSSTANDS



Send remittance by check, money order or U.S. Postage Stamps. Register letter if it contains cash or currency.

SHORT WAVE CRAFT
99R Hudson St. New York, N. Y.

**WONDER
Stories**

NOW

15c PER COPY

ON ALL NEWSSTANDS

THE GREATEST EVENT IN THE HISTORY OF SCIENCE-FICTION! This astounding reduction in the price of *WONDER STORIES* is the culminating step in our struggle to get on top and stay there! Science-fiction has always been an expensive luxury to lovers of action and adventure. NOW it can be enjoyed by everyone at the low prices of ordinary magazines!

If you have never read a science-fiction magazine before, due to their high cost, we heartily advise you to start now with the new popular-priced *WONDER STORIES*. We want you to buy one issue at your nearest newsstand—you can get the magazine everywhere—and read it thoroughly. We do not ask you to continue to buy it every month—we know you would not dare to miss an issue after reading the first!

Do yourself a favor—get acquainted with science-fiction now that you can afford it! Unlike most publications, the size and quality of *WONDER STORIES* is not reduced with the drastic price drop. You get as much for 15c as you could previously get for a quarter.

The Aug. issue contains many unusual, "out-of-the-way," and thoroughly absorbing stories of super-scientific fantasy (nothing technical, boring, or hard-to-read) by the leading authors in the field, plus one of the greatest murder mysteries ever penned, by a "slick" writer.

Glance through these names: Eando Binder, J. Harvey Haggard, Laurence Manning, David H. Keller, M.D., Edmond Hamilton, W. Varick Nevins III, John Beynon Harris, Stanley G. Weinbaum, Philip Jaques Bartel—if you have never seen them before, get acquainted with them—for they are about to become your favorite authors!

WONDER STORIES
99R Hudson St. New York, N. Y.
A GERNSBACK PUBLICATION

Please Say That You Saw It in *RADIO-CRAFT*

BOOK REVIEWS

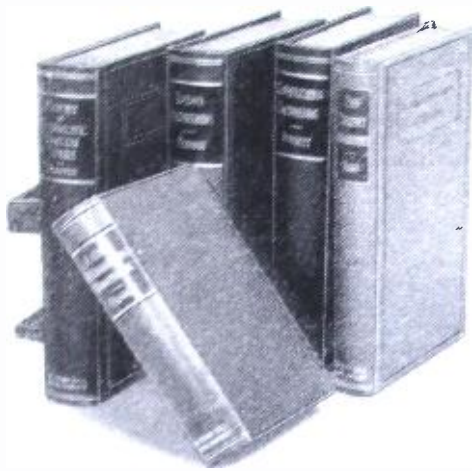

THE RADIO ENGINEERING LIBRARY. Published by McGraw-Hill Book Company, New York City. Composed of 5 volumes, 2,981 pages, nearly 2,000 illustrations. Price \$23.50.

These five books are all that the engineer is likely to need in a reference library of modern radio engineering practice. The Library contains: Everitt's Communication Engineering, Terman's Radio Engineering, Chaffee's Theory of Thermionic Vacuum Tubes, Hund's High Frequency Measurements, and Henney's Radio Engineering Handbook.

Everything is covered from fundamental tube and circuit phenomena to the essentials of the major fields of application. Chaffee's recent and warmly received book on thermionic emission and the vacuum tube gives a thorough and advanced treatment of amplification, detection, rectification and oscillation.

SPRAYBERRY VOLTAGE TABLES. Published by F. L. Sprayberry, Washington, D.C. Size, 9x11 ins., 285 pages, paper bound. Price \$2.00.

Here is a very valuable reference book for the Service Man. It contains hundreds of voltage tables for all types of sets. This will eliminate a lot of guesswork when checking a set for normal voltages. A comprehensive chapter has been included dealing with the proper measurement of voltages and various meter connections. The measurement of each branch of a circuit is taken up in detail.

D & S RADIO TUBE MANUAL. Published by Earl Webber Company. Size, 8½x11, 200 loose-leaf pages, paper bound. Price \$1.50.

All the essential sales and service information about radio tubes has been compiled in this single volume. This manual takes the mystery out of tube selling. It speeds up sales, saves time and results in prompt and efficient service to your customers. Tube base diagrams and full characteristics are given for over 250 types of tubes. It also goes into the matter of substitution very thoroughly.

MICROPHONES AND ACCESSORIES. Published by Shure Brothers Company, Chicago, Ill. Size, 8½x11, loose-leaf form.

A wealth of technical information on microphones and associated equipment is contained in the Shure technical bulletins. They are really a treatise on sound transmission. An excellent chapter is devoted to a comparison of the condenser and the two button microphones. The field problems in microphone placement is covered in detail as well as general electro-acoustic engineering.

CASE RECORDS OF BROADCAST RECEIVER REPAIRS. Published by Capitol Radio Research Laboratories, Washington, D.C. Size: 9x12 ins.

loose-leaf binder, 1500 case records. Price \$4.75.

"Case Records" is a compilation of successfully completed service jobs, covering over 3,000 models of 108 receiver makes. Each case recorded tells all the details for a satisfactory repair. In addition it contains notes on antenna construction, complete information on condenser testing, valuable information on restringing dial cables, and detailed information on various types of hum. It also contains data on neutralization of all circuits requiring same.

AUTO RADIO INSTALLATION & SERVICING. Published by Hygrade Sylvania Corp., Emporium, Pa. Size 4½x6 ins., 80 pages, paper bound. Free for the asking.

The practical experience of auto Service Men has been compiled into a handy manual. It is complete in every detail and it is filled with many valuable working hints that will help anyone associated with this branch of the service business.

Contents include: General engineering information, installation, interference suppression, tubes, service kinks and miscellaneous information.

AUTOMOBILE RADIO INSTALLATION & SERVICE. A specially prepared home study course by the International Correspondence Schools, Scranton, Pa.

Today the enterprising radio dealer and Service Man are giving auto radio their very serious consideration. However a number of questions are present when considering entering this field, such as: What new equipment and facilities are needed? What must I study in automotive engineering to understand the radio installation and service?, how can I best cooperate with the neighborhood garage and auto stores? etc.

These and other questions pertaining to this branch of the business are covered thoroughly in this course.

NATIONAL UNION RADIO LOG. A very useful magazine for the radio Service Man and his customers. It contains a complete list of American broadcasting stations, short-wave stations, a short-wave time table and interesting pictures and news about the broadcast artist. Space is provided on the front cover for the imprinting of the dealer's or Service Man's name and address.

SYLVANIA TECHNICAL MANUAL. The Sylvania Technical Manual, now going into its fourth printing, has been brought up to date by the addition of characteristics and technical data on two recently announced tubes, types 6A6 and 83V. For the benefit of owners of previous editions, this information was also published, in convenient form for clipping, in the November issue of "Sylvania News." The manual contains 100 pages, completely illustrated. Price 10 cents.

SYLVANIA NEWS. This is the monthly house organ for radio Service Men which is published by the Hygrade Sylvania Corp. It contains a Service Exchange department devoted to unusual radio service troubles.

TELEVISION-THEORY AND PRACTICE, by J. H. Reyner, Published by The Sherwood Press, Cleveland, Ohio, 1935. Size 6 x 9 ins., 196 pages.

This book treats television in its true light, that of a science which does not hesitate to face difficulties and to assess facts at their true value. As far as possible the subject has been considered from the first principles and an attempt has been made to convey fundamental information which will be of real value to the student of the subject. All of the systems used in America and Europe are fully covered by text and illustrations. The book is well written by one who understands the subject, and it is profusely illustrated.

Please Say That You Saw It in RADIO-CRAFT

Bring Your TUBE CHECKER and ANALYZER UP-TO-DATE with "DEPENDABLE" ADAPTERS

Set for TUBE CHECKERS . 75c
Set for ANALYZERS . . \$1.00
BOTH SETS, Postpaid, . \$1.50

PROVIDES for new metal tubes, and each set includes an insulated double control grid cap and lead. Modernizes any standard make free-point tube tester and analyzer.

Buy from your wholesaler (*Insist on R.C.P. "DEPENDABLE Adapter Set"*), or order direct.

New "DEPENDABLE" Test Equipment includes many additional features. Greater values than ever before.

Write Dept. RC-8
for Free New Catalog

RADIO CITY PRODUCTS CO.
28-30 W. Broadway, N. Y.

ORO * SCOPE

Underground

METAL DETECTOR

Locates metals, minerals, bullion metal ores. Not affected by water. Depth ranges to 22 feet. We are the originators of the Electric Gold Pan and the Oreometer, to assay metal ores.

ORO * SCOPE SALES
Tucumcari, Hot Springs, N.M.

WHEN CHOOSING A RADIO SCHOOL

RCA Institutes, with its reputation established by 26 years service, is an institution recognized as an important factor in the radio industry. Whether elementary radio principles or advanced subjects, sound applications or practical radio engineering, RCA Institutes is prepared to give you the instruction you need.

RESIDENT SCHOOLS NEW YORK AND CHICAGO
with modern standard equipment
EXTENSION COURSES FOR HOME STUDY
under convenient "no obligation" plan
Illustrated Catalog on Request.

R. C. A. INSTITUTES, Inc. Dept. RT-35
75 Varick St., New York—1154 Merchandise Mart, Chicago

DeHAEN'S
FLUORESCENT COLORS
For Cathode Ray Tubes and
Television Screens

Write for Color Card and Details
SOLE AGENTS FOR U. S. A. AND CANADA
PFALTZ & BAUER, INC.
300 Pearl St., NEW YORK CITY

Be sure to read complete details about the 1935 Official Auto-Radio Manual in the advertisement which appears on the Inside Front Cover of this issue.

The new 1935 GUIDE to GREATER PROFITS!

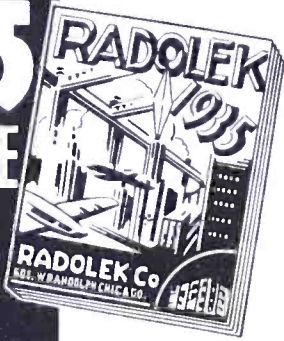

Bigger and Better Than Ever
The Radolek New 1935 Profit Guide is the most complete Radio Serviceman's "Buying Guide" ever published. 148 pages of valuable money-saving "radio-buying" information, the most accurate, complete listings of thousands of Radio Parts, Test Instruments, Tools, Amplifiers and Radio Receivers—8,000 items always in stock—available to you at the lowest wholesale prices.

Valuable Information
The Profit Guide is more than an ordinary catalog. Packed with new diagrams, charts, data and illustrations, this big catalog is a valuable reference book.

You Need This Book
Take advantage of the hundreds of "specials" and genuine bargains offered by Radolek. Send for this latest 1935 Profit Guide—now. RADOLEK restricts distribution of this catalog to active and legitimate Radio-Men. Please enclose your business card or letterhead.

COUPON THE RADOLEK COMPANY
617 W. Randolph St., Chicago, Ill.
Please Rush the 1935 Profit Guide.

Name
Address
City
Are you a Service Man? Dealer
Years Experience

RESISTOR SPECIALISTS

Featuring:

- NEW QUIET CARBON VOLUME CONTROLS
- VITREOUS RESISTORS
- TRUVOLT RESISTORS
- POWER RHEOSTATS

Write Dept. RC-8 for Catalog

175 Varick St., New York, N.Y.
ELECTRAD
INC.

Hi & Low Tone Equalizer \$2.45

HUMFREE "ALLOY" CASTING CAT. No. 2: 3 1/2" x 3 3/4" x 3 3/4"—75c. Described in July Radio Craft. Write for prices on Alloy High Permeability, Low Cost, High Grade Transformers—24 Hour Service—Audio Power Transformers. BUILT TO ORDER.

ALLOY TRANSFORMER CO.
135R Liberty St. New York City

● SERVICEMEN!

Complete line Replacement Parts, Short Wave and All-Wave Receivers, Amplifiers, Test Equipment and Accessories. All at Rock Bottom Prices.

FREE
NEW
1936
RADIO
BARGAIN
CATALOG

CONSOLIDATED RADIO PRODUCTS CO. 5540 Webb Ave., DETROIT, MICH., Dept. 22H

SIMPLE OPERATING PHONO. FEED MECH- ANISM

IN response to the demands of both professional and amateur disc-recorders for a feeding mechanism that would be extremely simple to operate, the Sound Apparatus Co. has developed such an instrument.

The result as illustrated, has proved more than satisfactory. Note that there are no clutches, or levers to manipulate; and no difficult adjustments to make. It is made to cut 100 lines per inch.

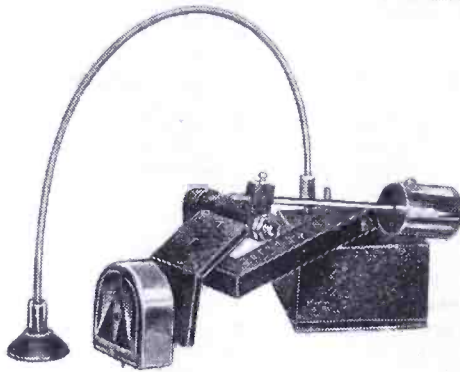

The recording mechanism—note flexible shaft.

TELEVISION-TYPE COMPONENTS

THE following interesting information concerning the suitability of certain commercial components for use in television apparatus is furnished by courtesy of Aerovox Corporation.

Power Resistors of Compact Dimensions. Through the careful choice of materials as well as advanced design, wire-wound vitreous-enameled power resistors of surprisingly small bulk are now available. (They are known as "Pyrohm Jr." resistors.) These units are obtainable in 5, 10, 15 and 20 W. ratings, and in all standard resistance values from 100 to 100,000 ohms.

Bakelite-Case Paper Condensers. In assemblies where high-voltage insulation and a minimum of metal are desirable, Aerovox bakelite-case paper condensers are proving popular. These units, available in 200, 400, 600 and 1,000 V. ratings, and capacities of .05 to 1 mf.

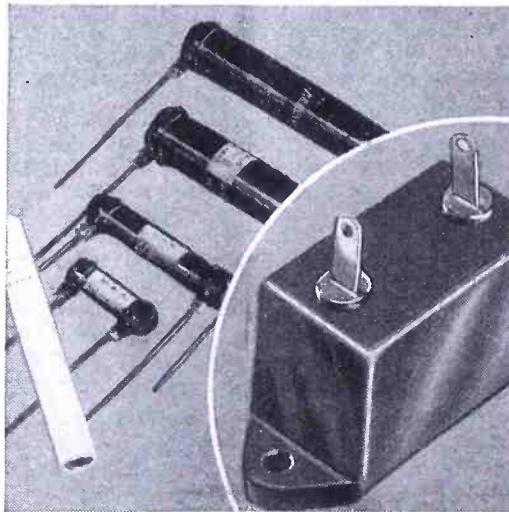

Television-type resistors and condensers.

FREE BLUE PRINT

The August issue of **SHORT WAVE CRAFT**, which is now on all newsstands, contains a free blue print of the new **UNIVERSAL HOOKUP-BOARD**. This is an idea developed by Hugo Gernsback whereby by simple means you can build over 100 sets simply by changing the connections on the Hookup-Board.

Don't fail to get this issue.

● Index to Advertisers ●

A	
Aerovox Corporation.....	117
Alden Products Company.....	125
Allied Radio Corp.....	111
Alloy Transformer Corp.....	128
Amperite Corporation.....	102, 119
Arndt, M. H., Mfg. Co.....	110
B	
L. Mitchell Barcus.....	113
C	
Carmi Transformer Works.....	114
Central Radio Labs.....	111
Classified Section.....	110
Clough-Brengle Company.....	113
Columbia Sound System Corp.....	112
Consolidated Radio Products Company.....	128
Cornell-Dubilier Corp.....	115
Coyne Electrical School.....	65
D	
Allen B. DuMont Labs.....	125
E	
Electrad, Inc.....	128
F	
First National Television, Inc.....	106
Freed Radio Company.....	117
G	
General Cement Mfg. Co.....	111
General Transformer Corp.....	109
Grenpark Company.....	120, 122
H	
Hammarlund Mfg. Company.....	125
The Hickok Electrical Instrument Co.....	107
Hygrade-Sylvania Corp.....	105
K	
Kato Engineering Company.....	118
Ken-Rad Corporation.....	123
L	
Littlefuse Laboratories.....	115
Arthur H. Lynch, Inc.....	108
M	
McGraw-Hill Book Company.....	102
M & H Sporting Goods Co.....	108
Midwest Radio Corp.....	Inside back cover
The Muter Company.....	103
N	
National Radio Institute.....	67
National Union Radio Corp.....	115
O	
Oro*Scope Sales.....	127
P	
Pfaltz & Bauer, Inc.....	127
The Plan Shop.....	124
Popular Book Corp.....	126
R	
Radio & Technical Pub. Co.....	119
Radio Circular Company.....	121
Radio City Products Co.....	127
Radio Design Company.....	110
Radio Electric Service Co.....	108
Radio Publications.....	112, 116
Radio Trading Company.....	106, 108
Radio Training Association.....	125
Radolek Company.....	128
Raytheon Production Corp.....	119
RCA Institutes, Inc.....	127
Readrite Meter Works.....	121
Remington Rand, Inc.....	118
S	
S. O. S. Corporation.....	108
Solar Mfg. Company.....	113
Sound Apparatus Company.....	123
F. L. Sprayberry School.....	121
Supreme Instruments Corp.....	Back cover
T	
Thor Radio Company.....	109
Toledo Sound Equipment Labs.....	117
Triplett Elec. Instrument Company.....	104
Try-Mo Radio Company, Inc.....	118
W	
A. H. Waage Company.....	114
Wellworth Trading Co.....	104, 109, 110, 114
Wholesale Radio Service Co.....	119
Wright-DeCoster, Inc.....	123

(While every precaution is taken to insure accuracy, we cannot guarantee against the possibility of an occasional change or omission in the preparation of this index.)

Please Say That You Saw It in RADIO-CRAFT

SAVE UP TO 50% by BUYING YOUR RADIO *Direct from* MIDWEST LABORATORIES

Exciting World-Wide Entertainment... Full-Scope High Fidelity... Guaranteed with Amazing New **MIDWEST SUPER Deluxe 16-TUBE ALL-WAVE Radio!** (ALL FIVE WAVE BANDS)



Only Midwest Gives You Multi-Function Dial . . .

This dial was designed in keeping with the trend of the times, yet is not an airplane dial! It is a many-purpose dial that performs many functions. Now, Midwest guarantees that inexperienced persons can secure good foreign reception. Send for FREE miniature of actual rotating dial which clearly shows these outstanding advantages:

1. Dial calibrated in Kilocycles, Megacycles and Meters;
2. Call letters of American Broadcast Stations printed on dial and illuminated;
3. Slow-Fast, Smooth-Action Tuning;
4. Station Group Locator;
5. Simplified Tuning Guide Lights;
6. Simplified Select-O-Band Indicator;
7. Illuminated Pointer Indicator;
8. Silent Shadow Tuning—Improvement on Meter Tuning;
9. Centralized Tuning.



Acousti-Tone V-Spread Design

This sketch shows the V front Dispersing Vanes, that were developed by Midwest engineers as a result of a study of the directional effect of the Full Scope High Fidelity Speakers, used by Midwest. These Vanes spread the beautiful lace-work of the "highs" throughout the entire room in a scientific manner . . . directing the High Fidelity waves uniformly to the ear. Send for FREE 40-page catalog. It pictures the complete Midwest line of beautiful 1936 Acousti-Tone V-Spread consoles . . . and chassis . . . in four colors.



V-FRONT

30 Days FREE Trial!

BEFORE you buy any radio write for the new FREE catalog and see for yourself the many reasons why 110,000 satisfied customers bought their radios direct from the Midwest Laboratories and saved from 1/3 to 1/2. Why pay more than the direct-to-you laboratory price?

You, too, can make a positive saving of from 30% to 50% by buying this more economical way. Learn why Midwest outperforms sets costing up to \$200.00 and more. Never before so much radio for so little money! Midwest gives you triple protection with: **One-Year Guarantee, Foreign Reception Guarantee, Money-Back Guarantee.**

50 ADVANCED 1935 FEATURES Many exclusive features include: Micro-Tenuator . . . Fidel-A-Stat . . . Separate Audio Generator . . . Ceramic Coil Forms, etc. Only Midwest covers a tuning range of 9 to 2400 meters (33 Megacycles to 125 KC)—enabling you to easily and successfully tune in even low-powered foreign stations up to 12,000 miles away with crystal-clear, loud-speaker reception.

All 5 Wave Bands enable you to enjoy today's finest High Fidelity American programs. In addition, you get Canadian, police, amateur, commercial-airplane and ship broadcasts and

derive new delight and new excitement from unequalled world-wide broadcasts . . . England, France, Germany, Spain, Italy, Russia, Australia, etc. Send today for money-saving facts!

SENSATIONAL HIGH FIDELITY RECEPTION

This bigger, better, more powerful, clearer-toned, super selective, 16-tube radio gives you absolute realism—assures you of life-like, crystal-clear tone—unlike anything you have ever experienced before. You will hear one more octave—overtones—that cannot be brought in with ordinary radios. Now, hear every instrument, every voice, every shade and inflection of speech.



Take advantage of the amazing 30-day FREE trial offer. Send for FREE catalog.

SAVE UP TO 50%

TERMS as low as \$5.00 DOWN

DELIGHTED WITH SUPER PERFORMANCE

Davison, Mich. A radio engineer confirmed my opinion—that no other make of radio will compare with my Midwest for tone, selectivity, volume, ease of tuning and wide range. It is great entertainment.
R. F. Collier.



PRAISES WORLD-WIDE RECEPTION

Maysville, Ky. My friends envy my Midwest and say it beats theirs in price and performance. It is amazingly sensitive and brings in Holland, Spain, etc. Its full, rich, non-lading tone denotes super quality and advanced workmanship. W. E. Purdon, R. R. No. 1



MAIL COUPON TODAY! FOR FREE 30-DAY TRIAL OFFER and 40-PAGE FOUR-COLOR FREE CATALOG

MIDWEST RADIO CORP., Dept. 12B, Cincinnati, Ohio. Without obligation on my part, send me your new FREE catalog and complete details of your liberal 30-day FREE trial offer. This is NOT an order.

User-Agents Make Easy Extra Money Check Here for Details

Name: _____
Address: _____
Town: _____ State: _____
 Check here, if interested in a Midwest Auto Radio.

MIDWEST RADIO CORP.
DEPT. 12B CINCINNATI, OHIO U.S.A.
Established 1920 Cable Address MIRACO All-Codes

KEEP YOUR SERVICE MODERN

AS RADIO DEVELOPMENT
by equipping with **RADICALLY NEW 1936**
SUPREME INSTRUMENTS

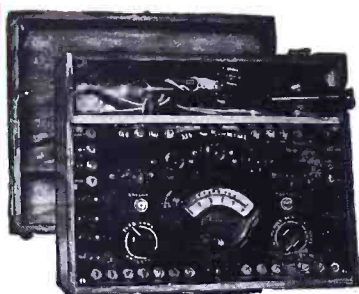

SUPREME 339—DE LUXE ANALYZER

A super-analyzer with direct resistance ranges up to 20 Megs, with self-contained power supply and many other features. \$39.95



SUPREME 89—STANDARD TUBE TESTER

A new low priced Tube Tester, featuring Supreme's famous Neonized leakage test . . . \$34.95

QUICK FACTS — — 89 DeLuxe

1. Simple to operate. (1) select filament voltage, (2) set tube selector per chart, and (3) press a button.
2. Accurate. New circuit tests all tubes at RATED LOAD.
3. Rugged. Cannot be damaged by shorted tubes.
4. Fool-proof. Only 5 sockets—a tube cannot be placed in wrong socket.
5. Neon Leakage tests. Detects leakages and "shorts" between ALL tube elements and indicates faulty elements.
6. Sensitivity of neon leakage test LIMITED so as not to discard good tubes.
7. Quality test detects open circuited elements.
8. All leakage and "short" tests while tubes are heated.
9. Extra handling avoided by making leakage and short tests in same socket used for Quality test on English Reading "Good-Bad" Scale.
10. Tests all tubes without adapters.
11. Fixed ratio between tube and circuit resistance for extreme accuracy on Quality tests.
12. Easily adaptable to future tube developments.
13. Adjustable to varying power supply.
14. First English Reading condenser tester.
15. Accurately classifies all electrolytic condensers as "Good" or "Bad" on meter scale.
16. Neon test of all electrostatic condensers indicating leakages, shorts, or opens.
17. Uses full size neon lamp—easy to see instantaneous leakages.
18. Supreme 5" fan shaped meter, 1000 ohms per volt sensitivity.
19. Volt-Meter for point-to-point testing. 5 D. C. ranges of 0-5, 0-125, 0-500, and 0-1250 volts, 1000 ohms per volt.
20. Ohmmeter. Direct ranges of 0-2,000, 0-20,000 and 0-200,000 ohms, powered with self-contained flash light battery. Low range to 1 ohm with 35 ohms marking at center scale.
21. Megohmmeter. Direct ranges of 0-2 and 0-20 megohms, SELF-CONTAINED power pack.
22. Single selector switch converts instrument to (1) English Reading tube tester, (2) neon tube leakage tester, (3) Neon Electrostatic condenser tester, (4) English Reading Electrolytic condenser analyzer, (5) Multi-range voltmeter, (6) multi-range ohmmeter, and (7) a double range megohmmeter.

Supreme 89
De Luxe
Tube Tester
\$45.95

Dealers Net Cash
Wholesale Price

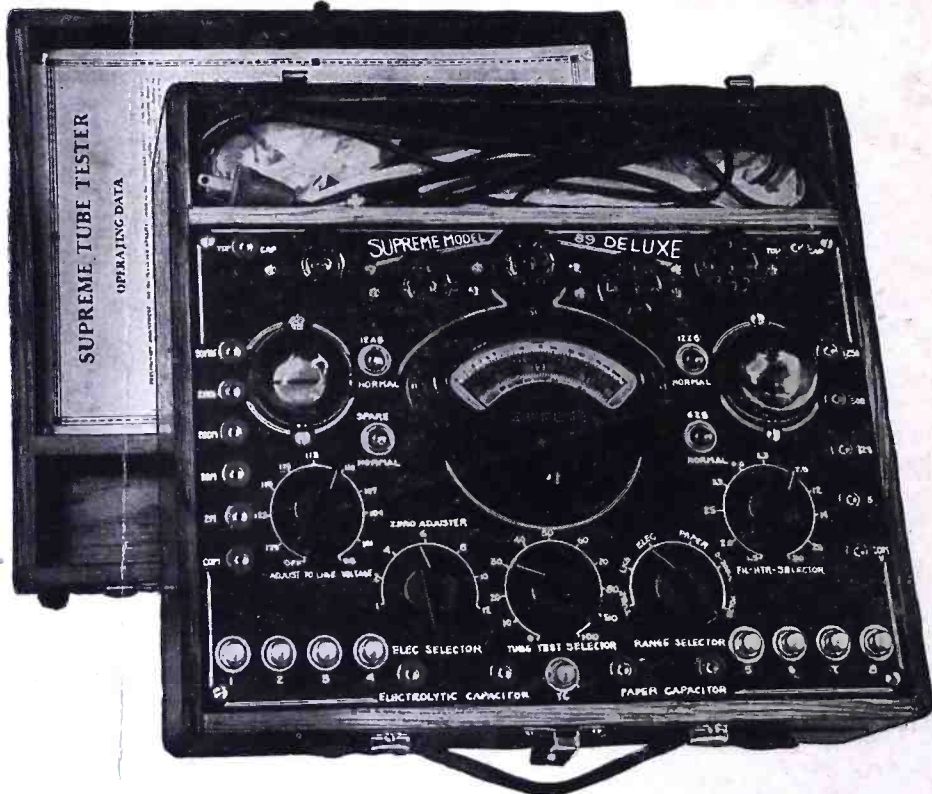

Makeshift methods don't appeal to the radioman who insists on progressive, accurate equipment. He knows he must keep his service as modern as radio developments. An examination of the new 1936 Supreme Instruments convinces him that here is NEW equipment specifically engineered for the new phases of modern servicing—and that accommodations for the new octal tubes is but an incident in the line-up of engineering improvement contained in this always outstanding group. Even more pleasing to him is the new low level of prices for a new high standard of manufacture and testing superiorities.

At \$45.95 the Supreme DeLuxe 89 Tube Tester is radio's greatest offering. Quality built in every detail—7 instruments in 1, 22 of its outstanding features are tabulated at left—but to really appreciate what it means in fast, skilled servicing, get your jobber to give you a demonstration.

URNS INSTRUMENT INSIDE OUT

You can definitely know the "inside story" of the instrument you buy before you buy. Check off here the instrument or instruments you are interested in. Write your name and address on margin below and address to:

Supreme Instruments Corp., Greenwood, Miss., and you will receive detailed, complete technical data. Written by engineers who have been servicemen and speak the serviceman's language—know what he needs for profitable production. No cost. No obligation. Supreme 89-DeLuxe Tube Tester. Supreme 89-Standard Tube Tester. Supreme 385-Automatic. Supreme 189-Signal Generator. Supreme 339-DeLuxe Analyzer. Supreme 339-Standard Analyzer. Supreme 391-P.A. Analyzer.



SUPREME 339—STANDARD ANALYZER

A new Free Reference Point Analyzer—the most outstanding value in the low price field . . . \$29.95



SUPREME 385—AUTOMATIC

A multi-unit instrument, combining features of 339-DeLuxe Analyzer and 89-DeLuxe Tube Tester, plus other flexibility features possible only through Supreme's exclusive uni-construction . . . \$77.95